

Radiation Treatment of Wastewater for Reuse with Particular Focus on Wastewaters Containing Organic Pollutants

**IAEA**

International Atomic Energy Agency

RADIATION TREATMENT
OF WASTEWATER FOR REUSE
WITH PARTICULAR FOCUS
ON WASTEWATERS CONTAINING
ORGANIC POLLUTANTS

The following States are Members of the International Atomic Energy Agency:

AFGHANISTAN	GERMANY	PALAU
ALBANIA	GHANA	PANAMA
ALGERIA	GREECE	PAPUA NEW GUINEA
ANGOLA	GRENADA	PARAGUAY
ANTIGUA AND BARBUDA	GUATEMALA	PERU
ARGENTINA	GUYANA	PHILIPPINES
ARMENIA	HAITI	POLAND
AUSTRALIA	HOLY SEE	PORTUGAL
AUSTRIA	HONDURAS	QATAR
AZERBAIJAN	HUNGARY	REPUBLIC OF MOLDOVA
BAHAMAS	ICELAND	ROMANIA
BAHRAIN	INDIA	RUSSIAN FEDERATION
BANGLADESH	INDONESIA	RWANDA
BARBADOS	IRAN, ISLAMIC REPUBLIC OF	SAINT VINCENT AND
BELARUS	IRAQ	THE GRENADINES
BELGIUM	IRELAND	SAN MARINO
BELIZE	ISRAEL	SAUDI ARABIA
BENIN	ITALY	SENEGAL
BOLIVIA, PLURINATIONAL	JAMAICA	SERBIA
STATE OF	JAPAN	SEYCHELLES
BOSNIA AND HERZEGOVINA	JORDAN	SIERRA LEONE
BOTSWANA	KAZAKHSTAN	SINGAPORE
BRAZIL	KENYA	SLOVAKIA
BRUNEI DARUSSALAM	KOREA, REPUBLIC OF	SLOVENIA
BULGARIA	KUWAIT	SOUTH AFRICA
BURKINA FASO	KYRGYZSTAN	SPAIN
BURUNDI	LAO PEOPLE'S DEMOCRATIC	SRI LANKA
CAMBODIA	REPUBLIC	SUDAN
CAMEROON	LATVIA	SWEDEN
CANADA	LEBANON	SWITZERLAND
CENTRAL AFRICAN	LESOTHO	SYRIAN ARAB REPUBLIC
REPUBLIC	LIBERIA	TAJIKISTAN
CHAD	LIBYA	THAILAND
CHILE	LIECHTENSTEIN	THE FORMER YUGOSLAV
CHINA	LITHUANIA	REPUBLIC OF MACEDONIA
COLOMBIA	LUXEMBOURG	TOGO
CONGO	MADAGASCAR	TRINIDAD AND TOBAGO
COSTA RICA	MALAWI	TUNISIA
CÔTE D'IVOIRE	MALAYSIA	TURKEY
CROATIA	MALI	TURKMENISTAN
CUBA	MALTA	UGANDA
CYPRUS	MARSHALL ISLANDS	UKRAINE
CZECH REPUBLIC	MAURITANIA	UNITED ARAB EMIRATES
DEMOCRATIC REPUBLIC	MAURITIUS	UNITED KINGDOM OF
OF THE CONGO	MEXICO	GREAT BRITAIN AND
DENMARK	MONACO	NORTHERN IRELAND
DJIBOUTI	MONGOLIA	UNITED REPUBLIC
DOMINICA	MONTENEGRO	OF TANZANIA
DOMINICAN REPUBLIC	MOROCCO	UNITED STATES OF AMERICA
ECUADOR	MOZAMBIQUE	URUGUAY
EGYPT	MYANMAR	UZBEKISTAN
EL SALVADOR	NAMIBIA	VANUATU
ERITREA	NEPAL	VENEZUELA, BOLIVARIAN
ESTONIA	NETHERLANDS	REPUBLIC OF
ESWATINI	NEW ZEALAND	VIET NAM
ETHIOPIA	NICARAGUA	YEMEN
FIJI	NIGER	ZAMBIA
FINLAND	NIGERIA	ZIMBABWE
FRANCE	NORWAY	
GABON	OMAN	
GEORGIA	PAKISTAN	

The Agency's Statute was approved on 23 October 1956 by the Conference on the Statute of the IAEA held at United Nations Headquarters, New York; it entered into force on 29 July 1957. The Headquarters of the Agency are situated in Vienna. Its principal objective is "to accelerate and enlarge the contribution of atomic energy to peace, health and prosperity throughout the world".

IAEA-TECDOC-1855

RADIATION TREATMENT
OF WASTEWATER FOR REUSE
WITH PARTICULAR FOCUS
ON WASTEWATERS CONTAINING
ORGANIC POLLUTANTS

INTERNATIONAL ATOMIC ENERGY AGENCY
VIENNA, 2018

COPYRIGHT NOTICE

All IAEA scientific and technical publications are protected by the terms of the Universal Copyright Convention as adopted in 1952 (Berne) and as revised in 1972 (Paris). The copyright has since been extended by the World Intellectual Property Organization (Geneva) to include electronic and virtual intellectual property. Permission to use whole or parts of texts contained in IAEA publications in printed or electronic form must be obtained and is usually subject to royalty agreements. Proposals for non-commercial reproductions and translations are welcomed and considered on a case-by-case basis. Enquiries should be addressed to the IAEA Publishing Section at:

Marketing and Sales Unit, Publishing Section
International Atomic Energy Agency
Vienna International Centre
PO Box 100
1400 Vienna, Austria
fax: +43 1 26007 22529
tel.: +43 1 2600 22417
email: sales.publications@iaea.org
www.iaea.org/books

For further information on this publication, please contact:

Radioisotope Products and Radiation Technology Section
International Atomic Energy Agency
Vienna International Centre
PO Box 100
1400 Vienna, Austria
Email: Official.Mail@iaea.org

© IAEA, 2018
Printed by the IAEA in Austria
October 2018

IAEA Library Cataloguing in Publication Data

Names: International Atomic Energy Agency.
Title: Radiation treatment of wastewater for reuse with particular focus on wastewaters containing organic pollutants / International Atomic Energy Agency.
Description: Vienna : International Atomic Energy Agency, 2018. | Series: IAEA TECDOC series, ISSN 1011-4289 ; no. 1855 | Includes bibliographical references.
Identifiers: IAEAL 18-01191 | ISBN 978-92-0-107818-6 (paperback : alk. paper)
Subjects: LCSH: Water — Purification — Irradiation. | Radiation chemistry. | Wastewater treatment and reuse. | Water — Purification — Organic compounds removal.

FOREWORD

The treatment of wastewater addresses the dual challenge of protecting public health and the environment in emerging and developed countries. It also is one of the key aspects of protecting water resources globally. Increasing amounts of chemical contaminants such as organics, pharmaceuticals, petrochemicals, pesticides and dyes resulting from agricultural, industrial or municipal activities are now being reported in water bodies. Above a certain threshold, these chemicals have the potential to negatively impact the ecosystem. Many of the chemicals are not effectively treated by the standard biological treatment processes commonly used for wastewater treatment and may require newer treatment methodologies.

Studies in several Member States have demonstrated that radiation initiated degradation of organics helps transform various pollutants into less harmful substances or render them amenable to management using existing wastewater treatment processes. The reliability and effectiveness of radiation technology has been demonstrated through the full scale application of electron beam treatment, in combination with existing biological treatment, to decompose sulphonated aromatic compounds in wastewater and to treat wastewater from the textile dyeing industry. However, before radiation technology could be adopted on a large scale for the treatment of wastewater from different sources, a comprehensive multidisciplinary study was needed to confirm the efficacy of the process for different pollutants, using optimized analytical and biological methodologies to characterize and evaluate the effects of likely by-products and to develop appropriate guidelines for wastewater treatment.

To address this need, in 2010 the IAEA initiated a coordinated research project entitled Radiation Treatment of Wastewater for Reuse with Particular Focus on Wastewaters Containing Organic Pollutants. The project focused on the applicability of radiation processing technology to treat wastewater contaminated with organic compounds (in combination with other processes), using validated analytical and biological methods to characterize and evaluate the effects of by-products in treated wastewaters. This publication is a collection of the work presented by the project participants at the final research coordination meeting, held in November 2015 at Tsinghua University in Beijing, China.

The IAEA wishes to thank all the participants for their valuable contributions. The IAEA officer responsible for this publication was S. Sabharwal of the Division of Physical and Chemical Sciences.

EDITORIAL NOTE

This publication has been prepared from the original material as submitted by the contributors and has not been edited by the editorial staff of the IAEA. The views expressed remain the responsibility of the contributors and do not necessarily represent the views of the IAEA or its Member States.

Neither the IAEA nor its Member States assume any responsibility for consequences which may arise from the use of this publication. This publication does not address questions of responsibility, legal or otherwise, for acts or omissions on the part of any person.

The use of particular designations of countries or territories does not imply any judgement by the publisher, the IAEA, as to the legal status of such countries or territories, of their authorities and institutions or of the delimitation of their boundaries.

The mention of names of specific companies or products (whether or not indicated as registered) does not imply any intention to infringe proprietary rights, nor should it be construed as an endorsement or recommendation on the part of the IAEA.

The authors are responsible for having obtained the necessary permission for the IAEA to reproduce, translate or use material from sources already protected by copyrights.

The IAEA has no responsibility for the persistence or accuracy of URLs for external or third party Internet web sites referred to in this publication and does not guarantee that any content on such web sites is, or will remain, accurate or appropriate.

CONTENTS

INTRODUCTION.....	1
Application of gamma radiation for removal of organic pollutants from wastewater <i>H. Meguenni, M. Mahlous, S. Souilah, F. Djema, D. Bouchfer</i>	24
Toxicity assays applied on pharmaceuticals submitted to electron beam irradiation <i>S.I. Borrely, F. Tominaga, N. Boiani, V.H. Ogihara-Silva, A.C. Teixeira, E.Barbieri</i>	37
Degradation of 3-Chloro-4-Hydroxybenzoic acid in biological treated effluent by gamma irradiation <i>L. Chu, J.L. Wang, Y. Liu</i>	45
Advanced treatment of industrial textile wastewater by electron beam based technologies: lab- and pilot-scale experiments <i>C. Chen, Y. Zhang, L. Zhang, W. Luo, J. Yu, S. He, J. Wang</i>	58
Radiation treatment of wastewater for reuse with particular focus on wastewaters containing organic pollutants and removal of heavy metals from wastewater <i>E-S.A. Hegazy, H. Abdel-rehim, E.M. Shehata, G. Adel, S. Elbakry, N.EL-Deghiedy</i>	68
Ionizing radiation induced degradation of monuron in dilute aqueous solution <i>E. Takács, S. He, K. Kovács, V. Míle, L. Wojnárovits</i>	83
AOP degradation of emerging organic contaminants: ionizing radiations, ultrasounds, UV-TiO ₂ hybrid techniques and their scale-up <i>M. Saracino, S. Montanari, M.L. Navacchia, M.L. Capobianco, B.Esposito, S.S. Emmi, A.Zanelli</i>	92
Treatment of pharmaceuticals/antibiotics in wastewater by combination of zeolite adsorbent with ionizing radiation <i>M. Taguchi, Y. Kumagai, A. Kimura</i>	106
Removal of EDCs from industrial sludge by E-beam <i>B. Han, J.K. Kim, Y.R. Kim, S.T. Jung, J.H. Park, J.S. Choi, H.O. Park, W.S.Shin</i>	117
Enhanced biodegradability of pharmaceuticals and personal care products by ionizing radiation <i>H.Y. Kim, T.-H. Kim, YU S., M.J. Lee, O-M. Lee</i>	127
Radiation treatment for recycling of industrial wastewater for industrial usage- biological and irradiation treatment of mix industrial wastewater in flood mitigation pond at prai industrial zones <i>K.A. Bakar, J. Sharif, S. Saralaselambakkanu, T.T. Ming, N. Isnin, H.N. Osman, S. Iasahhashim</i>	136

Research laboratory and feasibility study for industrial wastewater effluents treatment by radiation <i>Z. Zimek, K. Roman, S. Długoń, W. Gluszewski, M. Sudlitz</i>	146
Application of ionizing radiation on the cork wastewater treatment <i>J. Madureira, A.I. Pimenta, R. Melo, S. Cabo Verde, F.M.A. Margaça, L. Popescu, A. Besleaga</i>	156
Extensive use of gas chromatography – mass spectrometry for the characterization of the effects of radiation treatment of wastewater <i>M. Virgolici, V. Moise, M. Cutrubinis, D. Negut, I. Stanculescu</i>	165
Radiation induced treatment of organic pollutants <i>E. Ergun, Ö. Kantoğlu, M. Ince H.T. Ergüder, F.B. Dilek</i>	180
Combined electron beam –chemical oxidant technologies for treating organic pollutants in municipal wastewater: cost-benefit and business model development <i>S.D. Pillai, R.S.Reimers</i>	192
ACRONYMS AND ABBREVIATIONS	202
LIST OF CONTRIBUTORS TO DRAFTING AND REVIEW	207

INTRODUCTION

1. BACKGROUND

Chronic shortages of water in arid and semi-arid regions of the world and environmental policy regulations have stimulated the use of appropriate technologies in treating wastewater for reuse, for example, in urban irrigation, industrial uses (cooling, boilers and laundry), gardens and parks, cleaning purposes, etc. Additionally, water re-use is becoming increasingly important in large industrial centres, where water scarcity represents high operational costs for impounding and adduction. Industrial effluents often carry chemical contaminants such as organics, petrochemicals, pesticides, dyes and heavy metal ions. The standard biological treatment processes commonly used for wastewater treatment are not capable of treating many of the complex organic chemicals that are found in varying quantities in the wastewaters (e.g. persistent organic pollutants, POPs). Another important problem arising is the increasing presence of pharmaceuticals and endocrine disruptors compounds in municipal wastewater entering into the receiving stream, for which new treatment techniques and procedures are needed to remove excreted drugs before releasing the effluent into public waterways or reuse. Table 1.1 lists the major pollutants presents in waste waters and sludges. Radiation-initiated degradation of organics helps to transform various pollutants into less harmful substances or reduce their levels below the permissible concentrations. Studies in several Member States have demonstrated the usefulness and efficiency of radiation technology for treatment of different organic pollutants.

The lack of comparative data in pilot scale studies using radiation technique (alone or in combination with other methods) is a major issue in further utilization of this method for wastewater treatment. There was a need to study further the radiation effects, reliability and cost on specific group of organic pollutants in cooperation with other stakeholders who are involved in using other technologies. Therefore, focus of this CRP was on (i) to study the effects, reliability and costs of room temperature radiation processing technology and determine the optimized radiation dose and procedures, in combination with other processes, to treat wastewater contaminated with low and high concentration of organic compounds; (ii) to validate analytical methods to characterize and evaluate effects of by-products in treated wastewaters; (iii) to obtain data on radiation method to treat wastewater with different concentration of organic pollutants and compare it with data from conventional and novel technologies; (iv) to develop guidelines for selection of areas where the radiation treatment has high potential for rendering treated wastewater suitable for industrial and irrigation purposes. The Members States participating in the CRP were well equipped to carry out such studies in close collaboration with each other and the major facilities available.

2. CRP OVERALL OBJECTIVE

To enhance Member States capacity in applying radiation technology in combination with other techniques for improving environmental safety aspects through effective treatment of wastewater contaminated with organic pollutants and support reuse of treated wastewater for urban irrigation and industrial purposes. This was in line with the objective of the project 2.5.2.5 to enhance Member States capacity in applying radiation technology for managing agricultural and industrial waste and effluents and decontamination of biological agents.

2.1 Specific Research Objectives:

- To compare radiation technology with conventional and novel technologies such as Reverse Osmosis, Ultra- and Nano- Membrane Filtration, Activated Carbon Adsorption, and Advanced Oxidation Process (AOP) as Ozonation, UV, Sonolysis, Fenton process, in regard to costs and effects for different application cases and local situations;
- To assess the analytical methods to characterize and evaluate the effects on micropollutant reduction as well as impacts of radiation by-products in treated wastewaters (aquatic ecotoxicity studies);
- To study the effects, reliability and costs of room temperature radiation processing technology for specific groups of contaminants and specific application areas where the radiation technology is promising according to the assessment of existing knowledge;
- Determination of optimized radiation dose and procedures for different application cases, in combination with other pre- and post-treatment processes for contaminated wastewaters;
- To develop guidelines for selection of areas where the radiation treatment has high potential for rendering treated wastewater suitable for industrial and irrigation purposes including boundary conditions for successful application.

3. SCOPE

To examine the applicability of radiation processing technology to treat wastewater contaminated with organic compounds, in combination with other processes, using validated analytical and biological methods to characterize and evaluate effects of by-products in treated wastewaters.

3.1 Expected Research Outputs

The CRP was envisaged to yield the following outputs:

- Procedures and technical requirements, including optimal radiation doses, for radiation treatment of wastewater contaminated with microbiological pollutants and organic compounds; scope for treatment of different pollutants in wastewaters;
- Improved analytical and biological methods to characterize and evaluate the effect of radiation and the effects of by-products in radiation-treated wastewaters;
- A comprehensive feasibility study comparing radiation technology and the conventional technologies to treat wastewater for reuse purpose;
- Guidelines for selection of areas where the radiation treatment has high potential for rendering treated wastewater suitable for industrial and irrigation purposes, in order to facilitate the utilization of this technology in interested Member States.

The CRP was expected to enhance the capability of Member States in the use of radiation processing technology to treat wastewater contaminated with organic pollutants and support reuse of treated wastewater for urban irrigation and industrial purposes.

4. STRUCTURE

The CRP was structured around four RCMs. The first RCM was held from 7 to 11 May 2011 at the IAEA Headquarters in Vienna, Austria.

The second and third RCMs were held from 29 October to 2 November 2012 and from 18 to 23 May 2014 in Jeongeup, Republic of Korea and Budapest, Hungary respectively. The detailed meeting reports from these two events were compiled as working materials and can be accessed online.¹

The fourth and final meeting of this CRP was held at Tsinghua University, Beijing, China from 15 to 19 November 2015.

¹. Report of the 2nd RCM on Radiation Treatment of Wastewater for Reuse with Particular Focus on Wastewaters Containing Organic Pollutants:

http://www-naweb.iaea.org/napc/iachem/working_materials/RC-1188-2-report.pdf

Report of the 3rd RCM on Radiation Treatment of Wastewater for Reuse with Particular Focus on Wastewaters Containing Organic Pollutants:

http://www-naweb.iaea.org/napc/iachem/working_materials/3rd_RCM_summary_wrkpl_concl_recommend-V3-20140525.pdf.

5. ACHIEVEMENTS, SUMMARY, CONCLUSIONS AND RECOMMENDATIONS

5.1 Achievements of the CRP

5.1.1 *Scientific Achievements*

5.1.1.1 Challenging pollutants

This CRP investigated a wide variety of challenging pollutants in wastewaters originating from opium processing, cork industry, pharmaceutical industries, textile wastes, plastic industries, chemical fertilizers, municipal wastes, etc. The CRP focused on contemporary and emerging pollutants such as antibiotics, antidepressants, pharmaceuticals, soda wastes, reactive dyes, textile dyes, pesticides, oleo chemicals, endocrine disruptors, pathogens, Perfluorooctanoic acid (PFOA) and enteric viruses. The ability to address this diverse set of pollutants with one core technology is noteworthy. There was significant progress made in the conceptual design and specifications of a movable/transportable eBeam treatment plant.

5.1.1.2 Ecotoxicity

The inclusion of ecotoxicity assays in determining the potential environmental toxicity of the radiation technology treated wastewater is also of significance. The rationale for including ecotoxicity as an end-point measurement of radiation treatment of this diversity of pollutants was novel. The choice of a particular ecotoxicity assay was based on the predicted radiation treatment by-products. The CRP resulted in the development and testing of new ecotoxicity assays. For example, the use of mammalian cell toxicity assays for evaluating the toxicity of radiation by-products of cork industry wastewater treatment is noted.

5.1.1.3 Radiation Chemistry

This CRP has allowed for a deeper understanding of the underlying chemistry that is occurring when different type of wastewater is exposed to varying ionizing radiation sources. For example, work performed in this CRP by Hungary has shown that the first intermediate in the reaction of the OH radical with the benzene ring is usually hydroxycyclodieryl type radical and that the initial degradation products are OH derivatives of the original compounds. For compounds containing Cl atoms connected to the benzene ring the electron-withdrawing effect of Cl atom increases the rate of nucleophilic reaction while decreasing the electrophilic reaction. Studies in Japan have shown that chlorinated pharmaceuticals/antibiotics are decomposed by gamma irradiation and that trace amounts of chloride released during irradiation when combined with zeolites was almost twice that that produced when irradiation is performed in pure aqueous solutions. Studies in Poland have elucidated the possible mechanisms of the sedimentation process of non-organic pollutants during separation that is initiated by ionizing radiation. Studies with the emerging pollutant PFOA in the United States have detailed the electron beam treatment efficacy as a function of dissolved oxygen, organic carbon and nitrates. The effect of the presence and absence of oxygen on the decay of Rhodamine B solution was studied in Egypt. These studies highlight the formation of Rh B*, an intermediate species in the bleaching process and the formation of O_2^{*-} / OOH^* which is inhibited in the case of deaerated Rhodamine B solution. This CRP highlighted the value of radiation technology to enhance biodegradability of effluent and enhancing hydrogen production for sewage sludges.

In the course of these studies new analytical methods were either developed or classical methods were modified specifically to address the objectives of this CRP. Pulse radiolysis set

up with kinetic spectroscopic detection was used to follow the kinetics of irradiation treatment intermediates. Other methods include the mammalian cell ecotoxicity assays, ELISA, ZR-75 cancer cell lines, and the yeast two-hybrid assay for measuring estrogenic activity, and analytical techniques for directly measuring endocrine disruptors. The classical DNA comet assay was also adapted specifically to determine microbial DNA damage during eBeam irradiation.

5.1.1.4 Emerging pollutants

This CRP investigated a wide variety of emerging pollutants such as antibiotics, antidepressants, pharmaceuticals, soda wastes, reactive dyes, textile dyes, pesticides, oleochemicals, endocrine disruptors, pathogens, PFOA, and enteric viruses under both experimental and at pilot scales. The research findings will have significant implications in the use of this technology for industrial wastewater treatment, municipal wastewater and sludge treatment as well as water reuse projects. These studies have not only shed light on treatment possibilities but have also identified future research needs. One of the highlights of this CRP is the new information generated on the value of combination treatments such as ultra-sonication, biological treatment, and photocatalysis. Additionally the value of additives such as chlorine dioxide, ferrate, zeolites, and ion exchange resins on the overall treatment efficacy by ionizing radiation was illustrated during this CRP.

5.1.1.5 Comparison of Technologies and Combination of Technologies

Early during the CRP, the researchers identified that employing just irradiation technology by itself may not be the solution to have a technologically and economically feasible solution for addressing this wide variety of contemporary and emerging pollutants. This necessitated a new outlook on the use of radiation technology. It was understood that both a comparison of radiation technology with other technologies was important (to determine the economic feasibility). This appreciation drove the research endeavours towards identifying companion technologies that could be used in combination with radiation technologies. The technologies that were compared with radiation treatment were Fenton oxidation, UV, photocatalysis and chlorine disinfection. The combination treatments that were explored were ultra-sonication, biological treatment, chlorine dioxide, ferrate, zeolites and ion exchange resins.

5.1.1.6 New Analytical Methods and Experimental Test Beds

A variety of analytical methods were either adapted during the course of this CRP. These included pulse radiolysis with kinetic spectroscopic detection (for radiation chemistry), mammalian lung 8549 and mouse RAW 264.7 cells (for ecotoxicity measurements), ELISA, ZR-75 cancer cell lines and the yeast two-hybrid assay (for measuring estrogenic activity), analytical techniques (for directly measuring endocrine disruptors) and the DNA comet assay (to visualize microbial DNA damage). In addition to the analytical methods, considerable effort was spent towards designing and fabrication of hardware to facilitate these research needs. Examples include pilot scale sludge and wastewater treatment and biological treatment systems.

5.1.2 Cost Benefit/Economic Analysis

This CRP showed that the economics of radiation technology to treat wastewater organic contaminants was competitive with current technologies especially pollutants that are currently problematic for the industrial and municipal wastewater industry. The participants included detailed economic analysis as part of their activities. Radiation technology was

compared to conventional treatments to better identify the value proposition and cost benefits. Significant effort was spent on interacting with relevant stakeholders to obtain accurate information on contemporary technologies for the economic analysis. This CRP was unique in that it went beyond just laboratory based experiments to demonstrate feasibility. The studies progressed into commercial feasibility studies using mobile eBeam platforms and identification of regulatory, technological, and human factor roadblocks standing in the way of widespread commercialization of this technology. This CRP has also shed light on the possible improvements on mobile eBeam platforms to expand radiation technology applications. A major highlight of the activities and recognition of this CRP has resulted in investment in accelerator R&D in the USA, China and Republic of Korea. There has also been strong interest in potentially financing a small-scale electron beam facility for R&D applications in Romania. The industrialization of this technology is also at the final stages in Turkey.

5.1.3 Technology Transfer

The outcomes of this CRP have resulted in strong interactions and outreach with different stakeholders in the wastewater industry. These have included discussions with end-users, regulatory stakeholders, and equipment providers. Additionally, there have been collaborative efforts between researchers and equipment providers in seeking investments for commercialization. Outreach and educational activities such as seminars, discussions, chalk-talks, chapters in wastewater industry manuals, presentations in wastewater industry conferences were highlights of this CRP. The experiences of operating a commercial-scale eBeam treatment plant for textile dyes in the Republic of Korea provided invaluable insight into the technology and its adoption in the industry. This experience with the technology enabled the construction of an eBeam based treatment plant for textile dyes in China.

5.1.4 Science Talent Development and Scientific Outputs

This CRP provided an outstanding opportunity for a number of individuals to be trained in various aspects of irradiation technology. This resulted in several Masters Theses and Ph.D. dissertations. Developing a deep science talent pool is critical to the success and sustainability of this technology. A number of peer-reviewed publications, conference proceedings, patents and invention disclosures were also generated during the course of this CRP, as Fig. 1 shows.

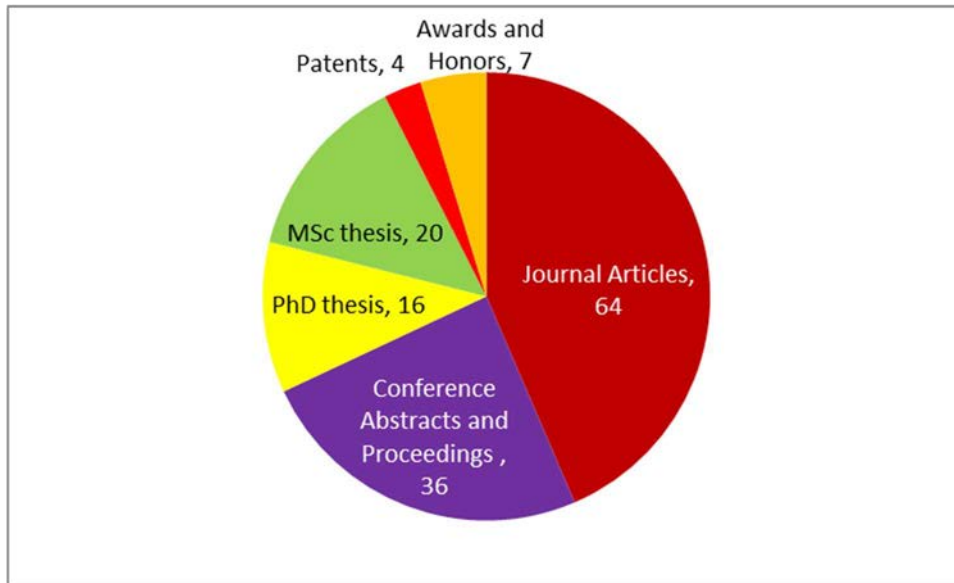

FIG. 1. Number of MSc and PhD theses, peer-reviewed publications, conference proceedings, patents and invention disclosures were also generated during the course of this CRP.

5.1.5 Cooperation between Countries

There were both bilateral and multilateral collaborations between the participating countries as well as with other member states during the course of this CRP (fig. 2). Examples of these collaborations are as follows:

- Hungary–Portugal (scientific exchange)
- Hungary–China–Republic of Korea (scientific exchange)
- Hungary–Brazil (scientific exchange)
- Hungary–Republic of Korea (scientific exchanges)
- USA–Romania (scientific exchanges)
- US–Republic of Korea
- Brazil–Republic of Korea
- China–US
- Poland–China
- Poland–USA
- Republic of Korea–Slovakia
- Algeria–Egypt
- US–Mexico
- Turkey–USA
- Malaysia–Republic of Korea
- Italy–Republic of Korea
- Italy–Hungary



FIG. 2. Bilateral and multilateral collaborations resulting from the CRP.

6. IDENTIFICATION OF FUTURE NEEDS

This CRP has resulted in significant advances in our understanding of the use of radiation technologies for the treatment of wastewater containing organic pollutants. However, the activities during the course of this CRP have also highlighted a number of critical research and industrialization needs for treating emerging pollutants. The research needs include new analytical assays for measuring ecotoxicity and estrogenic activity, information on the radiation treatment of wastewater effluents for direct potable, industrial, and agricultural reuse focusing specially on emerging and extremely recalcitrant biological and chemical pollutants. New methods needed for processing solids such as sediments and sludges to measure estrogenic activity and other relevant contaminants and radiation by-products accurately. There is an urgent need for establishing industrial/pilot scale irradiation facility for wastewater treatment either as a fixed or movable setup. There needs to be a continued emphasis of stakeholder input, outreach, and education about the value of radiation technology for wastewater treatment. There is a need for continually determining the true life cycle costs of adopting radiation technology so that the value proposition is truly monetized.

7. SUMMARY AND ACHIEVEMENTS OF THE PARTICIPATING INSTITUTIONS

Algeria

Our previous works were dealing with the degradation of pesticides by gamma radiation. It was shown that dichlovos and chlorpyrifos-ethyl in aqueous solution were completely degraded at the dose of 10 kGy and 50 kGy, respectively. Concerning the degradation of

PAHs (Polycyclic aromatic hydrocarbons), it was shown that gamma radiation leads to the degradation of acenaphthene at the dose of 10 kGy and naphthalene at 30 kGy. The study of the effect of gamma radiation on industrial effluent wastewater showed that in global view, gamma radiation decreased significantly the contamination level, with the increase of the absorbed dose. In detailed view, the relative content of the naphthalene, 2,7 dimethyl in the effluent sample decreased with the increase of the absorbed dose. At the dose of 6 kGy the molecule was completely degraded. The COD of effluent sample presented a reduction of 58%, when 10 kGy dose was applied. In Algeria fenitrothion is used in agriculture and also used in public health programs (sewer) to fight against the larvae of mosquitoes and cockroaches. The HPLC analysis has shown that the dose of 50 kGy degraded 90% of the fenitrothion (FNT) contained in 150 mg/L aqueous solution. The gamma radiation decreases the concentration of the solute as a function of absorbed dose and acidifies the pH of FNT solution. Influent samples were collected and irradiated with delivered doses of 2, 4, 6, 8 and 12 kGy. The degradation study was followed by HPLC and GC-MS and the results revealed the presence of trace of fenitrothion in the influent control sample, which disappeared when the sample was irradiated at 2 kGy. However, no presence of by-products in irradiated influent sample was detected. The chemical oxygen demand (COD) for irradiated samples were analysed, compared to that non irradiated samples. The results show that gamma radiation reduced 46% of the COD of the effluent sample at the dose of 12 kGy. In view to reduce the presence of toxics molecules of pesticides (FNT) and PAHs (NAPH) a secondary process was used on glass column filled with cellulose fibre mechanically modified just after gamma radiation, to allow a purification of the effluent and the adsorption of the POPs (FNT, NAPH) and by-products radio-formed in the real wastewater sample. A synthetic solution of FNT and NAPH were submitted to gamma rays of ^{60}Co , the results showed that the POPs concentration decreased with the increasing of absorbed dose. The adsorption test and purification on glass column was carried out, the adsorption rate reached a value of 91% and 87% respectively. The wastewater collected sample was irradiated at 2, 4, 6, 8 and 10 kGy dose range, the decrease of the pH of the sample with the increase of the absorbed dose was observed. The degradation by gamma radiation and the adsorption by the modified cellulose study were followed by HPLC the results reveal the presence of trace of FNT and NAPH in the effluent control samples, these residues disappeared at doses of 10 and 8 kGy, respectively. When the secondary process was used, the adsorption rate of FNT and NAPH in the effluent control sample was about 50% and 60%, respectively. The chemical oxygen demand (COD) of irradiated and non-irradiated samples was determined. The results showed that gamma radiation at the dose of 10 kGy reduced 57% of the COD of the effluent.

- Gamma radiation at the dose of 10 kGy decreased significantly the contamination level of industrial effluent waste water that contains fenitrothion (FNT) and naphthalene (NAPH).
- A mechanically modified fibre is a good adsorbent for FNT and NAPH and eliminates 90% of contaminant in simulated waste water solution and adsorbs about 50% from the real waste water sample.

Brazil

During the CRP emphasis was given to the degradation of pharmaceuticals (fluoxetine, propranolol and Voltaren). Reactive dyes and textile effluents were also studied. These classes of compounds have been systematically irradiated at an electron beam accelerator, followed by toxicity measurements. Acute effects were reduced for 92% of samples processed by radiation at doses lower than 5 kGy. Often, when 10 kGy or higher doses were applied, the toxicity started to increase. Reactive dyes used in colouring cotton may result in formation of

vinylsulphone, sulphatoethylsulphone and hydroxyethylsulphone, among several other chemicals. Blue 222 coloured effluent was decoloured at 2.5 kGy and reused for cotton dyeing (batch scale). All experiments were performed at 1.4 MeV fixed energy at a Dynamitron electron beam accelerator.

- Toxicity assays with *V. fischeri* and Daphnids were successfully applied for measuring the benefits of radiation effluents processing of reactive dyes, textile effluents and pharmaceuticals (Prozac, Prozac + domestic sewage; Voltaren, Propranolol and Prozac + Propranolol; Prozac + Voltaren. Chronic and fertilization assays are in development (ceriodaphnia and zebra fish FET Test).
- Regarding real textile effluents, decolouration induced by EB radiation was more effective than the toxicity removal at 5 kGy. Two reuse experiments were performed using irradiated textile effluent, initially contaminated by blue-222 and several chemicals used for cotton dyeing processing (2.5 and 5 kGy). For this effluent a new toxicity assays was carried with *B. plicatilis* rotifer.

China (Shijin HE)

In the framework of the CRP on “Radiation treatment of wastewater for reuse with particular focus on wastewaters containing organic pollutants”, Chinese team developed studies on the implementation of ionizing radiation technology as a complementary treatment for industrial effluents and increase the added value of these wastewaters. Based on these assumptions, advanced treatments of industrial textile wastewater were conducted with a Rhodotron TT200 accelerator (lab-scale, Gamma facility as well) and a DG accelerator (pilot-scale) in CGNPC Dasheng Accelerator Technology Co., LTD in Suzhou, China. Effects of coagulation/flocculation, coagulation/flocculation + EB, Fenton, EB + Fenton on COD and colour indices removals were investigated. The results demonstrated that COD and colour indices were effectively removed by coagulation/flocculation, EB irradiation as well as Fenton reaction. However, the combination of EB and Fenton can significantly decrease COD and colour indices to below 50 mg/L and 10 times, respectively. A following pilot-scale demonstration study on EB irradiation of industrial textile wastewater also confirmed the lab-scale experiments. On the base of above results, a commercial treatment facility for the industrial textile wastewater now is under construction.

- Lab-scale experiments have been conducted by Gamma and electron beam irradiation.
- Pilot-scale demonstration has been investigated for the advanced treatment of real industrial textile wastewater.
- Commercial treatment facility for the industrial textile wastewater now is under construction.

China (Libing CHU)

The response mechanism of sewage sludge exposed to ^{60}Co gamma irradiation and the enhanced degradation of antibiotics sulfamethazine (SMT) in spiked sludge mixture in the presence of hydrogen peroxide were investigated. Gamma irradiation-induced degradation of a chlorinated organic compound, 3-chloro-4-hydroxybenzoic acid (CHBA) in treated effluent was studied.

- Gamma irradiation could disintegrate sludge flocs and release proteins, polysaccharides and extracellular enzymes into the bulk solution. The maximum

oxygen uptake rate decreased by 58%, and 99% of the culturable bacteria were inactivated at an absorbed dose of 25 kGy.

- The efficiency of sludge solubilization with aeration was increased by around 25% compared to that without aeration at absorbed doses of 2.5-9.0 kGy.
- Gamma irradiation was effective in removing SMT from contaminated sludge mixture. Addition of H₂O₂ exhibited a synergetic effect on the degradation of SMT, with the pseudo first-order kinetic constant *k* increasing by around 25%.
- CHBA was degraded effectively using gamma irradiation and the removal of CHBA followed the pseudo first-order kinetic reaction. Both of Fe²⁺ and H₂O₂ additives exhibited an obvious synergetic effect on the degradation of CHBA in the treated effluent following gamma irradiation.
- The degradation mechanism of CHBA using gamma irradiation was ascribed to the oxidation by ·OH and reduction by e_{aq}⁻ and H· radicals.

Egypt

Studies were made on radiation processing for remediation of polluted waters and wastewater especially those resulting from textile industry. The effect of ionizing radiation on Acid fast yellow G, Maxilon C. I. Basic, Reactive red SH.B and Direct blue 3B dyes was carried at different dye concentrations (25-150 mg/l). Almost complete degradation was achieved for low dye concentration (25-50 mg/l) at 1-3 kGy absorbed doses. Different dose rates (0.715, 1.08 and 1.43 Gy/sec - dose 3 kGy) were used to degrade the investigated dyes. It was found that as the dose rate increases the dye degradation rate decreases. The pH value of the solutions had a considerable effect on the dye degradation rate. For all investigated dyes, the lower the pH, the higher the dye degradation rate was. Chemical Oxygen demand and Total Organic Carbon were also determined. It was found that significantly higher doses were required for appreciable changes in COD. The COD reduction was explained by oxygen addition reactions following reactions of the radiolytic species. The oxidation reaction proceeds as long oxygen is available in the solution. The tendency of TOC, COD reduction and the change of pH values for all dye solutions were similar to each other. The presence of oxygen or H₂O₂ enhances the degradation of dyes even at low doses. The effect of pH on the G-value is dependent on the irradiation atmosphere.

The removal of the abovementioned dyes was investigated using hydrogels that were prepared by ionizing radiation as (N-vinylpyrrolidone-acrylonitrile) copolymer hydrogel and the alkali-treated hydrogel. The effect of time needed for the treatment of wastewater, pH and temperature of the feed solution on the absorption of dyes by hydrogels was investigated. The dye uptake for the NH₂OH-treated hydrogel (NVP/AN) is higher than that untreated one. The time needed for hydrogel to adsorb large amount of dyes reaches to 5 days. The dye uptake decreases with increasing pH. As the reaction temperature increases the rate of dye uptake increases.

Studies were also done on the degradation behaviour of Rhodamine B dye when exposed to gamma irradiation. The effect of oxygen on the decay of colour in Rhodamine B solution was studied and showed that oxygen accelerates the decay of the dye concentration. Proposed radiation degradation mechanisms of aerated and de-aerated solution of Rhodamine B showed the formation of Rh B· which is the intermediate species in the bleaching process and the formation of O₂-·/OOH· which is inhibited in case of de-aerated Rhodamine B solution.

Polyvinyl alcohol/acrylic acid (PVA/AA) microgels were prepared using electron beam irradiation. Immobilization of different titanium dioxide (TiO₂) concentrations on the surface

of the prepared PVA-AA microgel was carried out. Photo-degradation efficiency of TiO_2 /PVA-AA microgel against metanil yellow dyes was studied. TiO_2 /PVA-AA microgel activity increases with the increase of the amount of TiO_2 and results in an increase in the rate of the photo-degradation reaction. Easy recovery and better reproducibility made TiO_2 /PVA/AA valuable as a photo-catalytic degradation composite materials for safe treatment of textile wastewater.

Radiation enhancement of photocatalytic activity of conducting polyaniline- TiO_2 nanocomposites (PANI- TiO_2) for degradation of methyl orange dye under visible light was studied. TiO_2 , PANI and PANI/ TiO_2 nanocomposites were prepared. Photocatalytic degradation of methyl orange (MO) using low amount of PANI/ TiO_2 nanocomposite as a photocatalyst under visible light was investigated. The influence of TiO_2 content, concentration of An, An:APS ratio and different doses of gamma radiation on the photocatalytic activity of the prepared composites were studied.

Imprinted (Acrylamide /2-vinylpyrrolidone) (AAm/NVP) hydrogel was prepared by gamma-radiation for uptake Pb and Co ions from the aqueous environment. The imprinted hydrogel was evaluated for the binding capability towards Pb and Co ions in the aqueous environment and compared with non-imprinted one.

- Radiation processing for remediation of polluted waters and wastewater resulted from textile industry was studied. Almost complete degradation was achieved for low dye concentration (25-50 mg/l) at 1-3 kGy absorbed doses. Chemical Oxygen demand and Total Organic Carbon were also determined. It was found that significantly higher doses were required for appreciable changes in COD. The presence of oxygen during irradiation accelerates the removal of the dye.
- The removal of some dyes was also investigated using different hydrogels that were prepared by ionizing radiation.
- Immobilization of different concentrations of titanium dioxide (TiO_2) on the surface of radiation prepared hydrogels was carried out and their photo-degradation efficiency against textile dyes was studied. Radiation enhancement of photocatalytic activity of conducting polyaniline- TiO_2 nanocomposites (PANI- TiO_2) for degradation of methyl orange dye under visible light was studied.

Hungary

The high-energy ionizing radiation induced degradation of pharmaceutical compounds (diclofenac, ketoprofen, chloramphenicol, paracetamol, ibuprofen, salicylic acid, clofibrac acid, sulphonamide type antibiotics and penicillin derivatives) as well as pesticides (fenuron, monuron and diuron) was studied both by steady state gamma radiolysis and pulse radiolysis. Pulse radiolysis setup with kinetic spectroscopic detection was used to follow the kinetics of the intermediates and obtain their spectra.

Degradation mechanism was suggested for the reaction of both OH radical and hydrated electron with the investigated molecules. The decomposition was followed by chemical oxygen demand (COD), biochemical oxygen demand (BOD) and total organic carbon content (TOC) measurements. HPLC-MS/MS and GC-MS were used to identify the degradation products. Microtox toxicity test (using *V. Fisheri* luminescent bacteria) and activated sludge respiration inhibition test were used to follow the change in toxicity during irradiation.

The first intermediate in the reaction of OH radical with the benzene ring is usually hydroxycyclohexadienyl type radical. The first degradation products are OH derivatives of the original compounds. OH radical attacks mainly the benzene ring.

Hydroxyl radical ($\cdot\text{OH}$) and hydrated electron (e_{aq}^-) reactive intermediates of water radiolysis effectively degrade all of the contaminants investigated and strongly reduce the toxicity of solutions.

For compounds containing Cl atoms connected to the benzene ring the electron-withdrawing effect of Cl atom increases the rate of nucleophile reaction and decreases that of electrophile reaction.

The experiments proved that irradiation with 0.5 kGy were more effective for disinfection of purified wastewater than chlorination. Besides, with the same dose about 50% of COD and BOD were removed and the total coli and fecal coli content remaining after biological treatment also decreased to zero.

- The high-energy ionizing radiation induced degradation of pharmaceutical compounds as well as pesticides was studied both by steady state gamma radiolysis and pulse radiolysis.
- Pulse radiolysis setup with kinetic spectroscopic detection was used to follow the kinetics of the intermediates and obtain their spectra.
- The first intermediate in the reaction of OH radical with the benzene ring is usually hydroxycyclodienyl type radical. The first degradation products are OH derivatives of the original compounds. OH radical attacks mainly the benzene ring. Dechlorination was observed in both hydroxyl radical and hydrated electron reactions.
- For compounds containing Cl atoms connected to the benzene ring the electron-withdrawing effect of Cl atom increases the rate of nucleophilic reaction and decreases that of electrophilic reaction.

Italy

Emerging organic contaminants pass through the regular wastewater treatment plants. Advanced oxidation processes can solve this problem. About these subjects the paper "Water remediation 2.0: Advanced Oxidation Processes" is being published on *La Chimica e l'Industria*, an Italian journal with a readership ranging from academia, to professionals, to industrial specialists. Among the most detected in the environment, several emerging contaminants (ofloxacin, diclofenac, carbamazepine, benzophenone-3, benzophenone-4, and Triton X-100) were selected on the base of their chemical characteristics. Lab-scale test were performed with γ ray, e-beam, ultraviolet, ultrasounds, and TiO_2 .

The processes initiated both by electron-beam and γ rays on ofloxacin or on a multi-component solution show that pollutants are removed according to a first order process vs. dose. The mineralization process demonstrated to be equally feasible both under fully oxidative (H_2O_2 present) and under simultaneous oxidative-reductive conditions (no additive), although e-beam process shows a high loss of mineralization efficiency vs. γ treatment. By controlling dose rate and/or by adding H_2O_2 , the dose was changed over 7 order of magnitude.

By using ultrasound-UVC-TiO₂, the full degradation of the contaminants has been achieved but the mineralization was poor. The energy consumption of the ultrasounds does not justify the increasing of the degradation.

A 5 L UVC-photo-reactor equipped with about 0.25 m² TiO₂ gave 38% of mineralization of 10 L of 25 mg L⁻¹ contaminant solution in 6 hours. On these bases, research team participates to the application of two Innovation Actions of the EU program Horizon 2020: one on electron-beam treatment of wastewaters and one on plasma-based oxidation processes. The second one passed the first stage. The research team is partner of a project on UVC-TiO₂ treatment of agro-industrial wastewaters, applied to the Emilia-Romagna regional research program.

- Starting from lab-scale degradation of single molecule solutions by ionizing radiation, CNR-ISOF partner implemented its skills in the comprehension of mineralization mechanisms on multi-components solutions and it sets up the analytical methods for the contaminant detection.
- To compare efficacy of wastewater remediation of ionizing radiations to other AOP, CNR-ISOF partner sets up photochemical and photocatalytic processes even hybridized with ultrasounds and has begun comparative energetic evaluation and scale-up.

Japan

Endocrine disrupting chemicals (EDCs), 17 β -Estradiol and *p*-Nonylphenols, in water were decomposed by ionizing radiation. The oestrogen activities were estimated by ELISA of the yeast two hybrid assays, and eliminated by the irradiation. Biological activities of real waste water decreased less than 1 ng dm⁻³, which is the lower limit concentration of appearance of endocrine disrupting property, by the radiation. Economic cost of the treatment process of wastewater having biological activity by use of electron beam installed after commercial waste water treatment system was estimated at 17 yen m⁻³. Pharmaceuticals and antibiotics in wastewater were also treated by the combination method of activated sludge and ionizing radiation. The dose required for the treatment can be estimated by using the rate constants and concentration of dissolved organic compounds. Trace amounts of chlorinated pharmaceuticals and antibiotics in wastewater were treated by the combination method of ionizing radiation and hydrophobic high-silica mordenite-type zeolite adsorbent.

- Endocrine disrupting chemicals (EDCs) in water were treated by ionizing radiation. Estrogen activities of waters were estimated by ELISA or the yeast two hybrid assay, and eliminated by the irradiation.
- Biological activities of wastewaters irradiated by ionizing radiation decreased to less than 1 ng dm⁻³, which is the lower limit concentration of appearance of endocrine disrupting property.
- Economic cost of treatment process of wastewater having biological activity by use of electron beam was estimated at 17 yen m⁻³.
- Pharmaceuticals and antibiotics in wastewater were treated by the combination method of activated sludge and ionizing radiation. The required dose for the treatment of wastewater can be estimated by using the rate constants and concentration of dissolved organic compounds.
- Trace amounts of chlorinated pharmaceuticals and antibiotics in wastewater were treated by the combination method of ionizing radiation and zeolite adsorbent.

Malaysia

The objective of this study was to investigate the possibility to treat the wastewater from the flood mitigation Pond A using irradiation and biological treatment for recycling purpose. E-Beam was used to treat effluent from Pond A. Effects of different absorbed dose, beam current and beam energy were studied in the irradiation treatment. It was found that the wastewater can be treated at low dose (3 kGy). Higher beam current gives better removal efficiency of COD, suspended solids and colour. In addition, destruction of plasticizer in the wastewater was also studied using wastewater spiked with di(2-ethylhexyl) phthalate DEHP. It was found that it can be degraded when exposed to radiation. Aeration prior to irradiation improved the degradation rate. In irradiation treatment reduction of dose was investigated by introducing pre-treatment to the sample, so that operating cost can be minimized. Pre-treatment studied was filtration and ultrasonic. Results show that sample filtered with 450 um mesh has higher COD and TOC values compared to samples filtered with smaller mesh size. The filtered samples were irradiated and the COD was reduced between 0.98 – 4.87% for mesh size 50 – 450 um. The TOC ranges between 0.15 – 3.02%, respectively. Pre-treatment using ultrasonic for 5, 10 and 15 minutes prior to e-beam irradiation had improved the COD removal between 56 to 62%. At the meantime the TOC has reduced between 12.25 to 23.73% for every minute of the ultrasonic pre-treatment.

Biological treatment using activated sludge process was used for treatment effluent from Pond A. In the activated sludge system, the effect of hydraulic retention time (HRT) on the characteristics of the wastewater was studied in addition to the identification of the microbes. Results show that the removal efficiency of COD, suspended solids and colour is directly related to the HRT period. At 48 hrs. HRT, percentage reduction for COD, colour, suspended solid were 62.3%, 36.7% and 67.1%, respectively. While at 24 hrs. HRT, COD, colour and suspended solid were reduce by 26.0%, 14.9% and 61.3%, respectively. Steady state was obtained earlier (day 8) for the 48 hours HRT, compared to day 12 for 24 hours HRT. Six types of microbes were also identified in this study. Although 24 hours HRT gave significant result, study was continued to lower HRT, first by varying the mix liquor volatile suspended solid (MLVSS). The efficiency of activated sludge process (ASP) was quite high at higher concentration of MLVSS. In addition, reduction of COD, suspended solid and colour was directly proportional to MLVSS as well. At 3500 mg/l of MLVSS, the removal percentage of COD, suspended solid and colour was 69.4, 73.0 and 43.7%, respectively. The system stabilizes on sixth day for 3500 mg/L of MLVSS in comparison to 2000 mg/L of MLVSS which otherwise takes about nine days in order to stabilize. The second step is to reduce HRT by adding of wastewater from food industries as carbon source to effluent from pond A. By adding food based wastewater to the samples from pond A the COD, BOD₅ and colour had reduced from 100, 150, 50 to 90, 100 and 25, respectively.

- In the period of CRP project, the study focused on treatment of mix industrial wastewater using e-beam treatment and biological treatment separately for comparison. In e-beam treatment, minimization of absorbed dose was tried by changing the irradiation parameters such as beam energy, beam current and absorbed dose. For this purpose, pre-treatment of sample was also applied which involved ultrasonic and screening treatment.
- For biological treatment using activated sludge process, optimizing of operation process is the main concern. In this case, effect of hydraulic retention time (HRT), mix liquor volatile suspended solid (MLVSS) concentration and addition of food wastewater into mix industrial wastewater from Pond A was studied.

Poland

Manufacturing soda ash is recognized as an important sector of the chemical industry. Unfortunately, it has noticeable negative impact to the environment, particularly on the state of groundwater and surface water. The production plants of soda using Solvay method, common in Europe, are discharging huge amounts of solid and liquid wastes, the utilization of which is the subject of many studies, however leaving the problem unsolved. Due to above the national project “Application in soda industry waste utilization process coagulation stimulated by electron beam” was prepared. The aim of the project was to build pilot plant facility using electron beam, and develop a method of utilization of wastes from the production of soda ash by the Solvay method. In this project, the potential of radiation coagulation method and proposal a solution for the wastes streams to reduce the negative impact on the environment are intend to be demonstrated on large scale.

The study of wastewater treatment by radiation towards sedimentation processes contribution and physical-chemical separation of highly concentrated nonorganic pollutants deposited in specific industrial waste was initiated. Preliminary experimental work was done to establish basic parameters of radiation processing. Laboratory stand was build and the study was performed to confirm possible mechanism of the sedimentation process of nonorganic pollutants during separation initiated by ionizing radiation. The density profiles formation in various sedimenting suspensions and chemical destruction caused by electron beam were studied.

Laboratory equipment construction for effective electron beam implementation during radiation treatment process with controlled flow rate for irradiation vessel supply and auxiliary instrumentation including process parameters optimal selection was installed. Evaluation from technical and economical point of view of this specific radiation technology and feasibility study for industrial facility this type is one of the main outputs of the study.

- Physico-chemical studies on the effects of ionizing radiation on sludge sedimentation in the production of soda were performed.
- The consent of a production plant for joint technological research has been obtained.
- The poster “Laboratory EB Facility for Study Industrial Wastewater Effluents Treatment by Radiation” has been presented on 13th Tihany Symposium on Radiation Chemistry, held in Balatonalmadi, Hungary, 29 August – 3 September 2015.
- Starting M. Sudlitz doctoral studies in the field of radiolysis of wastewater from the production of soda.

Portugal

Under the CRP, studies were conducted on the implementation of ionizing radiation technology as a complementary treatment for industrial effluents from Cork industry and increase the added value of these wastewaters. Preliminary studies of the gamma radiation effects on the antioxidant compounds present in cork cooking water were carried out. Different antioxidant activity assays were used as Ferric Reducing Power (FRAP) assay, DPPH radical scavenging activity, reducing power and inhibition of β -carotene bleaching. The phenolics content was also evaluated by Folin-Ciocalteau method. Results pointed out that gamma radiation increases both the amount of phenolic compounds and antioxidant activity of cork cooking water. This conclusion becomes relevant thinking in the application perspective of the extractable compounds from cork wastewater should be used in other

industries like food or cosmetic ones. Thus, toxicity of these new compounds has to be evaluated. Ecotoxicity and cytotoxicity assays were done and the obtained results suggested two important outcomes: a) gamma radiation treatment does not affect the ecotoxicity of effluent which could reduce the environmental pollution problematics; b) cork wastewater cytotoxicity increases with gamma radiation treatment. Consequently, the applicability of the added-value cork wastewater by-products needs to be carefully studied to evaluate both the antioxidant potential and the cytotoxicity. Beside these studies, the removal of phenolic compounds was investigated using low-cost adsorbents: one synthesized and one commercial. Regarding the adsorption mechanism, the results suggested that both activated carbons are suitable for phenolic compounds extraction. However, the adsorption appears to be more favourable in the synthesized carbon. This was found to be mesoporous, which provides increasing accessibility to micropores and promotes the initial adsorption rate as well as selectivity for the four phenolic compounds adsorption. The overall results highlight the potential use of ionizing radiation as complementary technology in industrial wastewater treatment. However, several aspects have to be taken into account in order to reuse and optimize treated wastewater.

- Gamma radiation increases both the amount of phenolic compounds and antioxidant activity of cork cooking water.
- Gamma radiation treatment reduces the organic matter content but do not affect the ecotoxicity of cork cooking wastewater which could reduce the environmental pollution.
- Cork wastewater cytotoxicity increases with gamma radiation treatment.
- Different toxicity tests will help to a better understanding of ionizing radiation effects and will be important to target potential applications.

Republic of Korea (Bumsoo HAN)

Endocrine disrupting Chemicals (EDCs) are chemicals that may interfere with the humane body's endocrine system and produce adverse developmental, reproductive, neurological, and immune effects in both humans and wildlife. A wide range of substances, both natural and man-made, are thought to cause endocrine disruption, including pharmaceuticals, dioxin and dioxin-like compounds, polychlorinated biphenyls, DDT and other pesticides, and plasticizers such as bisphenol A. The high energy ionizing radiation has the ability to remove the EDCs with a very high degree of reliability and in a clean and efficient manner. The ionizing radiation interacts with matter both directly and indirectly. Direct interaction takes place with EDCs and the structure of EDCs has destroyed or changed. During indirect interaction, radiolysis products of water result in the formation of highly reactive intermediates that then react with the target molecules, culminating in structural changes.

A pilot scale experiment was conducted in EB TECH with sludge samples from the Textile Dyeing Complex in Daegu City. In this experiment, electron accelerator of 2.5 MeV, 100 kW with the dose rate of 40 kGy/s is used on the crushed sludge. Thickness of sludge is controlled from 2 to 10 mm; where to consider the range of 2.5 MeV electrons in sludge. The rate of sludge moving under the beam is controlled within the range of 5-10 m/min. The experiment were conducted with the doses up to 50 kGy at atmospheric temperature (20~25°C).

Analytical methods to detect the EDCs were developed based on HPLC and GC-MS. The concentration of EDCs in industrial sludge before and after irradiation was analysed with two different extraction methods (SPE and ASE-200). The removal ratio of Nonylphenol and DEHP was 83% and 80% at 10 kGy and 95% and 90% at 20 kGy, respectively, and the

required absorbed dose is 20 kGy, and it is higher than the required doses reported by others who made the experiments with the EDCs in aqueous system. Long term study of 60 days at 10 kGy shows the removal ratio of nonylphenol and DEHP 85% and 80%, respectively and it shows this technology is good to apply in industrial scale application.

- Pilot scale e-beam system (60 kg/d up to 50 kGy) to irradiate industrial sludge has been set up.
- Analytical methods to measure the EDCs were developed based on HPLC and GC-MS, and used to detect the NP and DEHP in industrial sludge.
- The removal ratio of NP and DEHP were 83% and 80% at 10 kGy and 95% and 90% at 20 kGy.
- Long term study (60 days) confirmed the reliability of industrial scale application.

Republic of Korea (Myun Joo LEE)

In the framework of CRP on radiation treatment of wastewater for reuse with particular focus on wastewater containing organic pollutants, field demonstration study on decomposition of antibiotics and endocrine disrupters contained in sewage effluent was conducted in KAERI. A MEB (Mobile Electron Beam) with 0.65 MeV, 33 mA and 20 kW, respectively, was constructed. This work was carried out over four seasons in order to make a sure the seasonal effect of temperature on decomposition of chemicals contained in effluent of sewage. The major antibiotics and endocrine disrupters with initial concentration of 0.5 mg/L were decomposed completely by the absorbed dose of less than 1.5 kGy, and bacteria and microorganisms were also inactivated under the same absorbed dose. Toxicity arising by antibiotics on algae was reduced by increasing absorbed dose. This technology acquired a certification on advanced treatment of sewage effluent by radiation, NET (New Environmental Technology), which is issued by the Republic of Korea ministry of environment and have been promoted to environmental industry.

- **Decomposition of antibiotics**

The concentrations of the antibiotics including lincomycin (LMC), sulfamethoxazole (SMX), and tetracycline (TCN) were exponentially decreased with increasing doses. More than 95% of target compounds were radiolytically decomposed at a dose of 1.5 kGy.

- **The change of biodegradability of antibiotics**

The biodegradability of antibiotics after irradiation treatment was assessed by monitoring the change in biological oxygen demand (BOD). As a control test, abiotic (no microorganism inoculum and without radiation treatment) and biotic degradation (microorganism inoculum and without radiation treatment) were compared to distinguish the elimination by the abiotic and biotic mechanisms. The results indicated that TCN was more resistant to abiotic hydrolysis than the other targets, whereas the LMC was resistant to biodegradation. However, the BOD of the radiation-treated antibiotics was significantly increased in comparison with the abiotic and biotic control. During the experimental period, the biodegradability compared to the biotic control was gradually increased. The results indicate that irradiation converts some portion of non-biodegradable antibiotics into biodegradable by-products. Biodegradability of irradiated TCN was the most enhanced, and LMC was less than the others, indicating that the by-products of irradiated LMC were still resistant to biodegradation.

- **Toxicity assessment**

The total algal toxicity after degradation process was significantly decreased in

comparison with the untreated control. However, in some cases, the observed toxicity was higher than the expected one, which indicates the existence of by-products or transformed compounds in the treated sample.

- **Kinetics**

Batch kinetic experiments with the initial aqueous concentrations of 2, 6, 8, 20 mg/L showed the decomposition of antibiotics using radiation followed a pseudo first-order reaction, and the dose constant increased with lower initial concentrations. For the comparison of kinetic models, the Monod equation was used. The kinetic parameters of maximum reaction rates (k_{max}) and half-velocity coefficient (K_s) are obtained. The k_{max} values ranged from 0.29 to 0.99 $\mu\text{M}/\text{Gy}$. The K_s values for antibiotics decreased in the order of: LMC > SMX > TCN. Radiolytic decomposition of antibiotics by radiation was well described by both a pseudo first-order reaction and the Monod equation.

Romania

Sewage water is the main problem to be tackled, as Romania had reported in 2010 a degree of connection to sewer of only 54.28% and a degree of connection to the sewage treatment plants of only 43.24%, which makes enough room for both conventional and non-conventional advanced water treatment technologies. A radiolytic study was carried out on model wastewater samples spiked with organochlorine pesticides, using hexachlorobenzene (HCB) and Polychloro Byphenils (e. g. PCB 52) as model target analytes. Experimental model sewer wastewater samples were irradiated at IRASM Multipurpose Irradiation Facility (IFIN–HH, Bucharest-Magurele), an industrial gamma irradiator with an activity of 288 kCi in January 2013. The absorbed dose received by the samples was between 1 and 13 kGy at a dose rate of 1 kGy/h. Dosimetric analysis was performed with ethanol-chloro-benzene dosimetry system. The organochlorine compounds and PCBs concentration was monitored by gas chromatography with simultaneous micro electron capture detection and mass spectrometric detection. ISO 6468:1996 sample preparation protocols were used for the recovery of target analytes from the wastewater matrix. The concentration of the target analytes decreased ten times after the irradiation treatment at absorbed doses around 1 kGy. A molecular modelling study was done to predict the most probable radiolysis products and in correlation with the GC/MS results to speculate some preferential radiolysis pathways. A feasibility study was made for installing at IFIN-HH a self-shielded electron accelerator (6 MeV, 12 kW, which can be re-located), which could cover all present and under development applications, including environmental applications of radiation technologies, like wastewater and sludge treatment for decomposition of POPs.

- A gas chromatographic analytical procedure for organochlorine insecticides and polychlorinated byphenyls quantitation and validation of ionizing radiation decomposition in municipal wastewater were successfully adapted.
- 2 Master thesis in collaboration with University of Bucharest;
- Knowledge transfer and exchange of experience with high visibility professionals in the field of environmental applications of radiation processing with a focus on wastewaters contaminated with POPs;
- Networking with participants at the CRP meetings and creating the opportunity and basis for future international collaborations within specific financing programmes (e. g. Horizon 2020, bilateral collaborations, IAEA CRPs or Regional Projects, etc.)
- Feasibility study for a self-shielded e-beam (6 MeV, 12 kW, which can be relocated) capable for demonstration of effluent treatment and other environmental applications

of technological irradiations. A project proposal submitted for financing the self-shielded e-beam infrastructure.

Turkey

In the present research, high strength effluents of Opium Alkaloid Plant located in Afyon Province of Turkey was investigated for its biological treatability combined with radiation processing, as its treatment has been standing problematic for years due to complex structural compounds contained. The aim of this study was to investigate the aerobic biological treatability of opium alkaloid industry wastewaters in conjunction with irradiation as means of pre-treatment in order to make a comparison of feasibility of the radiation and conventional treatment technology.

In this regard, optimization of the anaerobic digestion parameters in pilot scale were studied both for irradiated or non-irradiated wastewater. Up flow sludge blanket reactors (UASB) were set up for these purposes. In the reactors, COD was kept 26000 mg/L due to the inhibition of anaerobic bacteria over this COD content. Domestic wastewater was merged to opium production plant wastewater in the treatment facility in the range of 30–40%. After merging, the COD content was around 18000 – 26000 mg/L. Therefore, further improvement studies of the wastewater treatment was carried out up to this COD content. Total COD reduction of anaerobic digestion of irradiated wastewater was 4500 mg/L from 24750 mg/L with a treatment efficiency of 82%, whereas 58% for non-irradiated. When total cost of treatment was compared with conventional treatment, it was found to be 1.22 and 0.76 USD/m³ for conventional and radiation treatment, respectively.

- Dose rate effect on the mineralization of alkaloid wastewater has been identified.
- Required absorbed dose for complete mineralization has been determined by LCMS/MS analysis.
- Biological treatability of opium alkaloid industry wastewater combined with radiation processing in pilot scale level has been studied and achieved 82% treatment efficiency.
- Determination of toxicity of irradiated and non-irradiated alkaloid wastewater has been performed.
- Comparison of the feasibility of conventional and radiation combined treatment has been conducted.

USA

The research has shown that eBeam technology is capable of inactivating a variety of microbial pathogens in sewage sludges and wastewater effluent. The dose per the US EPA biosolid-related regulations will be more than capable of achieving significant reductions of microbial pathogens. The economic analysis of eBeam treatment of sewage sludge suggests that the costs for treating sewage sludges decreases as the throughput volumes increase with costs ranging between \$311/dry ton for a 50 MGD (million gallons/day) treatment plant and \$ 72 for a 100 MGD facility. This suggests that it would be significantly more cost-effective for this technology to be adopted by large and megacities such as Houston, Chicago, etc. However, the analysis also pointed out that the technology is currently limited in terms of high power accelerators. Accelerators that are in the 1 MW or greater are needed. However, no commercially available accelerators that are in the 1 MW class or higher power exist anywhere in the world. The economic analysis performed during this project clearly identified that 1 MW or higher accelerators are needed to be of real value to the wastewater industry.

The outreach and education activities targeting the wastewater industry stakeholders were successful. The metrics of success are based on the interest shown by the wastewater utilities as well as the initiation of a grant-funding program by the DOE to support the design and construction of 1 MW or higher accelerators.

- The inactivation kinetics of key microbial pathogens in wastewater sludge and effluents have been described.
- The economic analysis of incorporating eBeam technology into wastewater treatment plants have been performed.
- Active engagement with US Department of Energy have resulted in the DOE funding projects to develop high power (1 MW) class eBeam linear accelerator technologies.
- This CRP project has helped attract funding from a variety of sources to advance eBeam technology for wastewater and water reuse applications.
- Involvement in the CRP has promoted strong interactions with municipalities regarding adoption of eBeam technology into the drinking water and wastewater treatment plants.

8. CONCLUSIONS

The participants concluded that the CRP was successful in fully achieving its objective. All specific objectives had also been fully achieved, with numerous additional outputs. It was also concluded that:

- (1) The CRP was very successful in establishing collaboration among the members in terms of scientific visits, training fellowships, exchange of samples for characterization, providing support for irradiation and characterization of waste samples. This is reflected in achievements and proposals for new research projects.
- (2) The application of ionizing radiation has proved to be an efficient tool to remove toxic organic pollutants like pharmaceutical residues, pesticides, EDCs in proper quality for re-use, and demonstrated the synergetic effect with conventional treatment technology. The CRP members have agreed that this technology was easy to integrate to the existing system.
- (3) The technical and economic feasibility was proven by small scale and pilot scale researches under this CRP, and also demonstrated by mobile electron beam plant. The commercial scale plant for textile dyeing wastewater has already built in the Republic of Korea, and under construction in China.
- (4) In this CRP, it is agreed that the continued research to refine the target applications and wastewater characteristics for which ionizing radiation would be applicable. There was new information on the emerging pollutants such as POPs, EDCs, soda waste, PPCPs (pharmaceuticals and personal care products) and surfactants. Fundamental research to understand reaction kinetics and pilot scale operation with ionizing radiation demonstrated the ability of this technology to address those emerging contaminants.
- (5) Studies on actual wastewater to evaluate their eco-toxicity were recognized to be critically important, and the CRP members have agreed to increased cooperation and collaboration especially in the case of toxicity measurement for better understanding of ecological influence to the environment.
- (6) The CRP members acknowledged that the issue of emerging contaminants is an iterative process that arises from improved understanding of toxicity, regulatory changes, improved analytical instrumentation, and public perception. This has a significant impact on the availability of technologies for environmental remediation and therefore continued emphasis on these topicstics is warranted.

- (7) Keeping in view of the emerging and highly recalcitrant biological and chemical pollutants in environmental waters and effluents, there is a need for additional research focusing on using ionizing radiation technology for direct potable, industrial, and agricultural reuse applications. New radiation chemistry based reactants should be explored to specifically target the active principles of such pollutants for reduced toxicity. Therefore, a new and improved analytical assay for ecotoxicity assessment from matrix-pollutant interactions during irradiation is warranted. Particularly, new analytical assays for estrogenic activity are needed since many of the emerging pollutants are considered oestrogen disruptors. Continued efforts to identify beneficial reuse of irradiated wastewater solids and effluents are needed so that the value of the technology is continually maximized.

INDIVIDUAL COUNTRY REPORTS

APPLICATION OF GAMMA RADIATION FOR REMOVAL OF ORGANIC POLLUTANTS FROM WASTEWATER

H. MEGUENNI¹, M. MAHLOUS¹, S. SOUILAH¹, F. DJEMA¹, D. BOUCHFER²

¹Centre de Recherche Nucléaire d'Alger, 2Bd Frantz Fanon BP-399 Alger-RP

²ONA; Office National de l'Assainissement, Alger

Abstract

The present study is focused on the use of modified cellulose fibres of *Luffa cylindrica* as an adsorbent in a secondary process following radiation processing of waste water. The secondary process consists of adsorption of the rest of persistent organic pollutants (POPs) — pesticides and polycyclic aromatic hydrocarbons (PAHs) — and products of radiolysis in real samples. Gamma radiation was used for the degradation of organic compounds, first on a synthetic aqueous solution of fenitrothion (FNT) and naphthalene (NAPH), then on effluent sample of wastewater collected from a purification plant that receives domestic wastewater, industrial and sewer influent. The irradiated samples were submitted to the secondary process in glass column, to reduce the POPs and the products of radiolysis in a medium, by adsorption. The study was conducted on FNT and NAPH synthetic solutions each having a concentration of 150mg/l. The solutions were submitted to gamma rays of ⁶⁰Co to absorbed doses of 2, 4, 6, 8 and 10 kGy. The results showed that 99.7% of FNT were degraded at absorbed dose of 10 kGy. A complete degradation of NAPH was occurred at 10kGy. An adsorption by cellulose modified fibre was carried out on synthetic control solutions of FNT and NAPH. The adsorption rate reached a respective value of 91% and 87%.

The real sample was irradiated at the same dose range as the synthetic solutions. The results showed a decrease of the pH of the effluent sample with the increase of the absorbed dose. The degradation and the adsorption by the modified cellulose were followed by High-performance liquid chromatography (HPLC). The results revealed the presence of trace of FNT and NAPH in the influent control sample with a respective peak area of 303 and 132 mAU. The reduction of the peak area with the increase of absorbed doses was observed. A complete degradation of FNT and NAPH occurred at 10 kGy and 8 kGy respectively.

The adsorption by modified cellulose reduced the peak area of FNT and NAPH with respective adsorption rate of 53%–60% of the effluent control sample and reached 18% at the dose of 8 kGy for FNT and 28% at the dose of 6 kGy for the NAPH. The chemical oxygen demand (COD) of irradiated and non-irradiated samples was determined. The results showed that gamma radiation at the dose of 10 kGy reduced by 57% the COD of the effluent.

1. OBJECTIVE OF THE RESEARCH

The objective of the research is to study the effect of gamma radiation on the degradation of POPs (FNT, NAPH) and other organic pollutants. A secondary process was necessary to reduce by adsorption the rest of POPs and products of radiolysis present in the medium using modified cellulose fibres.

2. INTRODUCTION

In the wastewater treatment plant, the conventional treatment has low efficiency in the degradation of chemical compounds. The degradation by gamma radiation has been proved to be a promising method for the treatment of wastewater contaminated with organic pollutants [1]. Natural fibres have recently attracted the attention of scientists because of their

characteristics: biodegradable, renewable, low cost [2-4] and for their capacity for adsorbing organic compounds [5].

In this study, modified cellulose fibres of “*Luffa cylindrica*” were used as an adsorbent in a secondary process of wastewater treatment following gamma irradiation. The real sample of effluent was collected from a purification plant that receives domestic wastewater, industrial and sewer effluents. Thus, we started the study on a synthetic aqueous solution of FNT and NAPH.

In Algeria the FNT is used in agriculture and in public health programs (sewer) to fight against the larvae of mosquitoes and cockroaches. In this type of treatment, contamination leads directly into sewer water and then to natural aquatic environment. The NAPH present in the collected effluent sample comes from oil refinery.

Therefore, it is necessary to monitor the behaviour as well as the presence of FNT and NAPH and its by-products in the environment, to avoid the imbalance of marine and terrestrial ecosystems. Then, the study was focused first, on the degradation of POPs (pesticides, PAHs) present in real wastewater sample, after that comes a secondary treatment using glass column filled with cellulose fibres, mechanically modified for adsorption of the rest of POPs and products of radiolysis. The study of degradation and bio-adsorption were followed by HPLC. Gas chromatography–mass spectrometry (GC-MS) analysis is underway.

3. MATERIALS AND METHODS

3.1. Chemicals

Fenitrothion (FNT), analytical grade 95.4% purity, purchased from Reiedel-de Haen, was used without further purification. Naphthalene (NAPH), analytical grade 99.9% purity was purchased from Aldrich. Both of them were prepared in deionized water, protected from light and stored at 4°C.

All solvents supplied by MERCK, Darmstadt, Germany were HPLC-grade (acetonitrile, methanol). Anhydrous sodium sulphate was supplied by Fluka.

3.2. Preparation of samples

3.2.1. Synthetic solutions

The FNT and NAPH synthetic aqueous solution each having a concentration of 150mg /l, were dissolved in water in a proportion of volume 1/9 methanol/ deionized water [6], protected against the light with aluminium foil, and stored at 4°C.

3.2.2. Real sample

The wastewater samples were taken from the purification plant of the City (SEAAL) which treats wastewater by conventional way. The samples were collected in glass flasks, fitted with closures lined with aluminium foil, sunlight protected, and preserved for storing at 4°C prior to extraction and analysis.

3.2.3. Irradiation procedure

The FNT and NAPH synthetic aqueous solutions and the effluent sample were irradiated with Co-60 gamma rays at the doses of 2, 4, 6, 8 and 10kGy. Irradiation was conducted at room temperature at a dose rate of 18.47 Gy/min. The Frick dosimetry system was used to measure the dose rate.

3.2.4. Adsorption of POPs

The adsorption test of FNT and NAPH were performed on glass column with dimensions of 21cm height and 2 cm diameter. Each column was loaded with 1.5 g of modified fibres of Luffa. The amount of modified fibres occupied a height of 10 cm and the volume of the real samples poured into the column was 30 ml. The residence time of the sample was 30 minutes.

3.2.5. Analysis of irradiated solutions by HPLC

The POPs content in the solutions prior and after irradiation were followed by liquid chromatography analyses, an Agilent 1260 Infinity chromatograph equipped with a diode array UV/Vis detector using an Eclips XDB-C18 column of 4.6m length and 150mm internal diameter, 5µm film thickness, temperature of the oven was 25°C.

The detection of FNT in the aqueous stock solution ($C_0=150\text{mg/l}$) was realized at 210nm wavelength, the mobile phase was a mixture of water/ acetonitrile in volume proportions of 30%/70%, at 1ml/min flow rate with injection volume of 50 µl and retention time $R_t = 3.5\text{min}$.

The detection of NAPH in the aqueous stock solution ($C_0150\text{ mg/l}$) was realized at 218 nm wavelength with a mixture of Water/Acetonitrile in volume proportions of 30%/70% at 1 ml/min flow rate with injection volume of 20µl and retention time $R_t = 4.27\text{min}$.

3.2.6. Extraction procedure

The whole glassware was rinsed with acetone before the analysis. A liquid-liquid extraction was performed at ambient temperature. The synthetic solutions samples of FNT and NAPH of (C_0) and the real sample of effluent were liquid extracted with dichloromethane [8, 9] and poured into an Erlenmeyer. The extraction was performed with a magnetic stirrer during 30 min. After the mixed solution was poured into the separatory funnel, the phase separation was the organic phase was passed through a layer of anhydrous sodium sulphate in view to fixe remaining water. The organic extract was concentrated in a rotary evaporator at $38^\circ\text{C} \pm 1^\circ\text{C}$ to 2 ml and finally to dryness under a flow of nitrogen and re-dissolved in a volume of 1ml of acetonitrile, then analysed by HPLC and GC-MS.

4. RESULTS AND DISCUSSION

4.1. Effect of gamma radiation on the synthetic solutions

4.1.1 HPLC Analysis of the control solution of FNT

Fig. 1 shows the chromatographic profile of the control solution of FNT analysed by HPLC. The analysis revealed the appearance of the peak of FNT at retention time (R_t) of 3.5min with an area of 5049 mAU which represents 100% of the peak area.

Sample Info : C0 100 mg

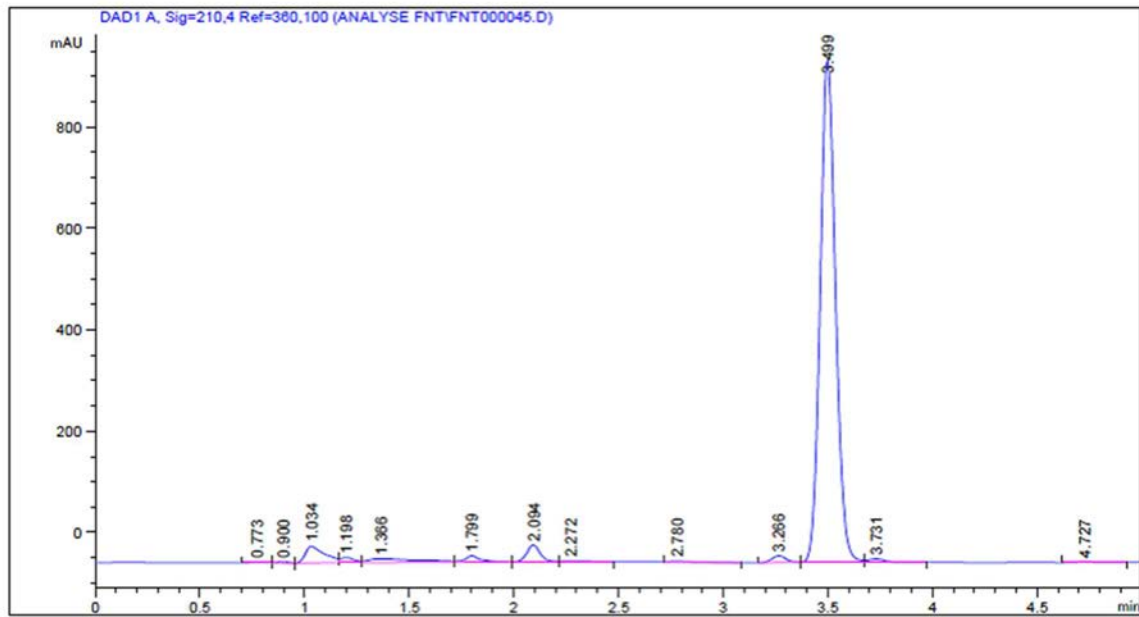

FIG. 1. Chromatogram of FNT control solution analysed by HPLC.

4.1.2. HPLC analysis of irradiated FNT synthetic solution.

The degradation rate of irradiated FNT aqueous solution at various doses is illustrated on Fig. 2.

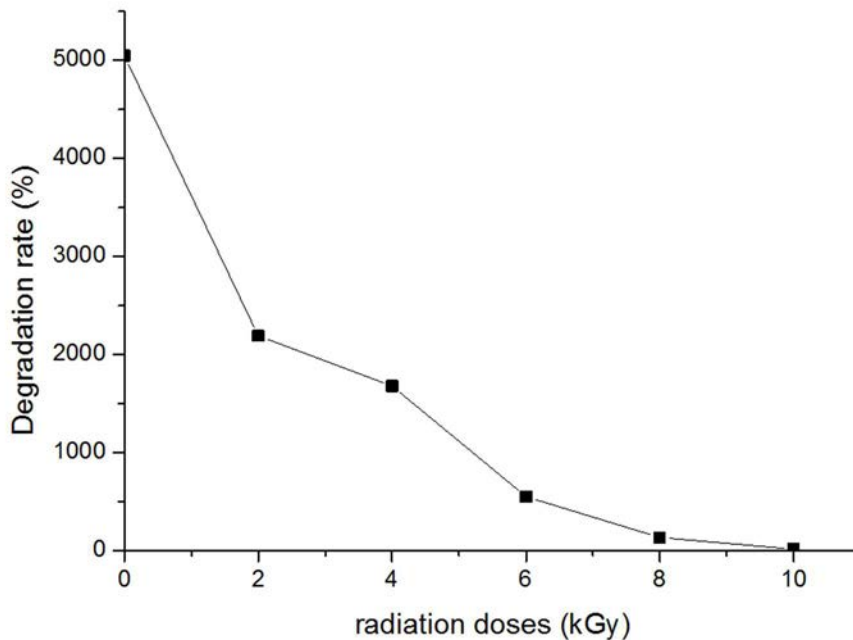

FIG. 2. Radiation effect on the degradation of FNT aqueous solution.

Fig. 2 shows a decrease of the peak area of FNT with the increase of the absorbed dose compared to that of control aqueous solution in Fig. 1 which passes from 5049 mAU to 2190

at 2 kGy absorbed dose. At the doses of 4 and 6 kGy the peak area decreases to a respective value of 1679 and 550 and reached 132 mAU when 8 kGy were delivered. The HPLC analysis showed a degradation of 99.7% of FNT at absorbed dose of 10 kGy, 0.3% of remained in the medium of the synthetic solution. The results shown that irradiation is an effective technique for the degradation of this molecule.

4.1.3. Adsorption test of FNT by modified cellulose fibres

Sample Info : C0 100 luffa cotton

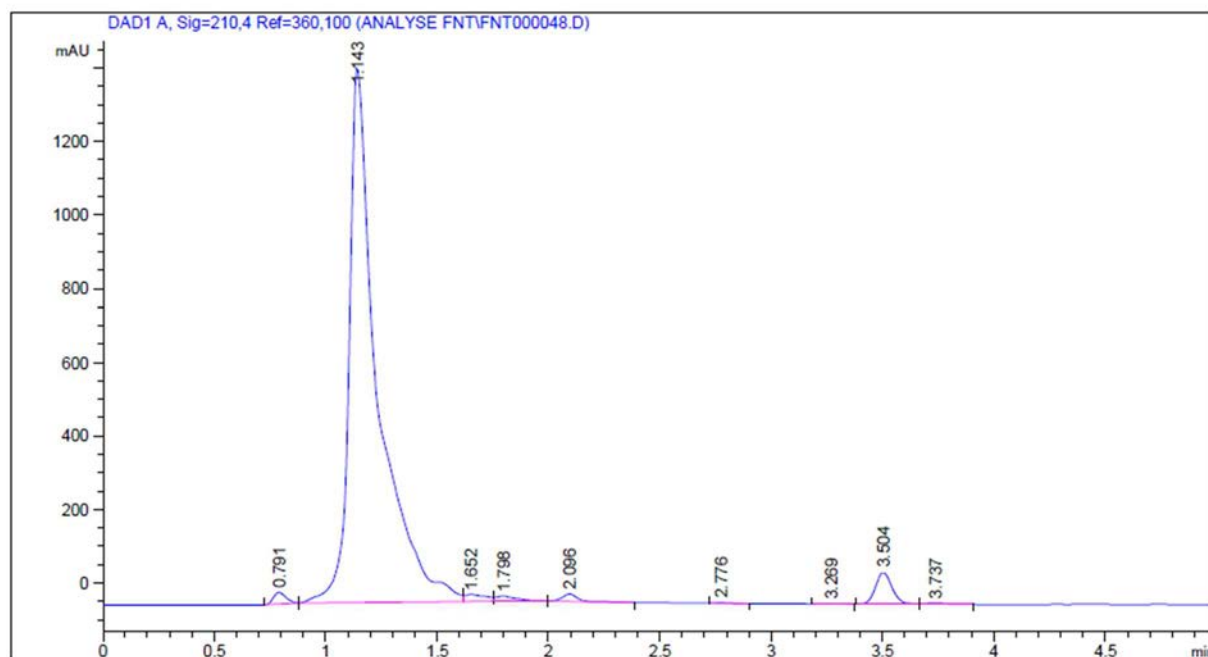

FIG. 3. Chromatographic profile of FNT adsorbed by the modified cellulose fibres.

Fig. 3 shows a decrease of the FNT peak area adsorbed by the modified cellulose fibre which passes from 5049 mAU to 441mAU when the modified fibre adsorbed 91% of FNT.

4.1.4. HPLC analysis of the control solution of NAPH

Fig. 4 shows the chromatographic profile of the NAPH control solution analysed by HPLC. The analysis revealed the appearance of the peak of NAPH at a retention time (Rt) of 4.27 min with an area of 21600 mAU which represents 100% of the peak area.

Sample Info : NAF C0

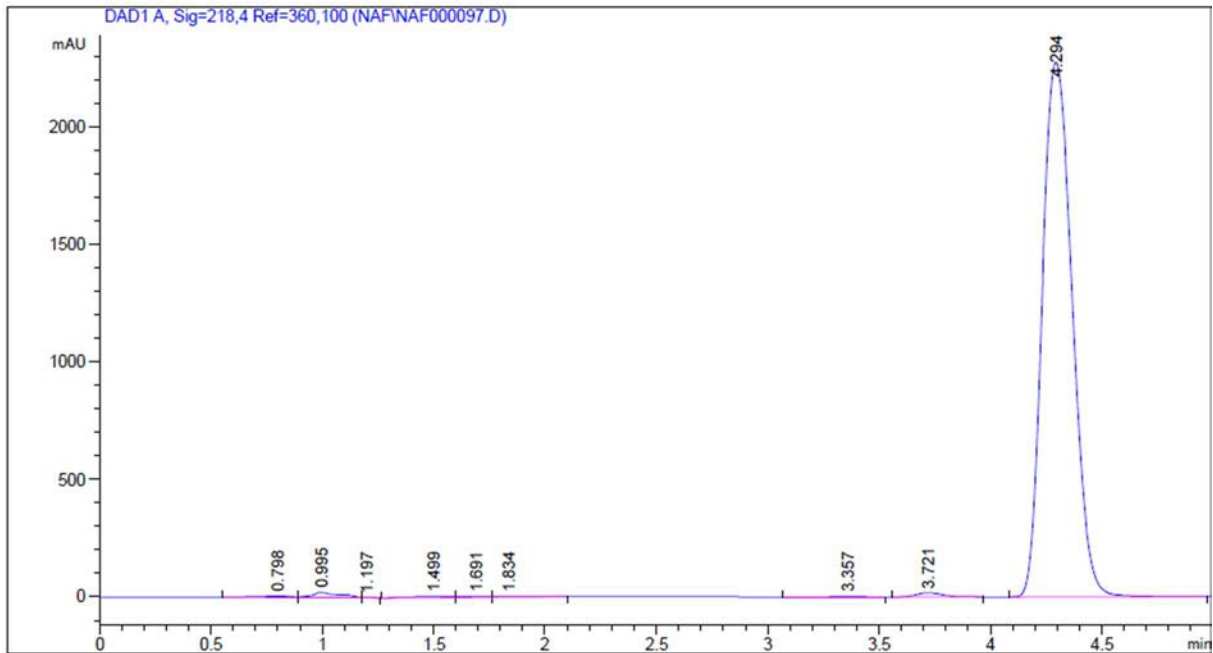

FIG. 4. Chromatogram of NAPH control solution analysed by HPLC.

4.1.5. HPLC analysis of irradiated NAPH synthetic solution.

The decrease of FNT aqueous solution peak area at various doses is illustrated on Fig. 5.

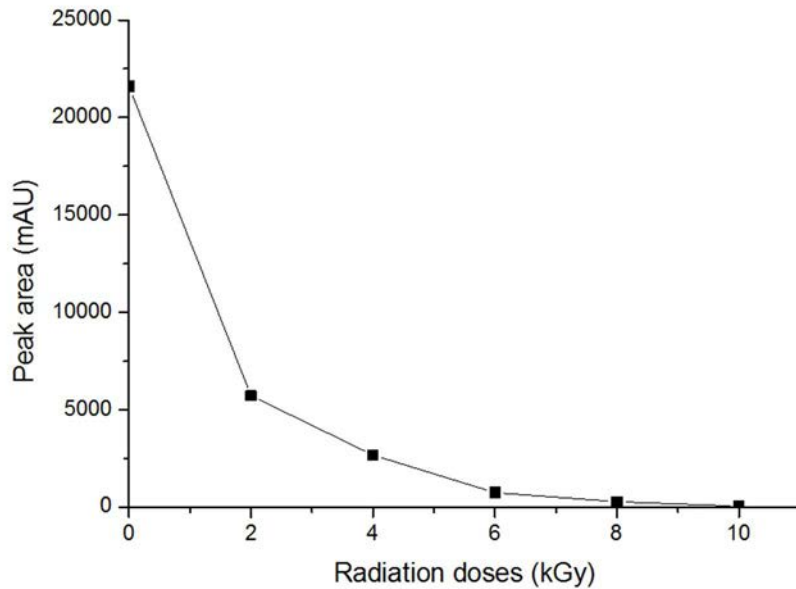

FIG. 5. Radiation effect on degradation of NAPH aqueous solution.

Fig. 5 shows a decrease of the peak area of NAPH with the increase of absorbed dose compared to that of control solution in Fig. 1 which passes from 21600 mAU to 5732 at 2 kGy

absorbed dose. At the doses of 4 and 6 kGy the peak areas continue to decrease to a respective value of 2692 and 764 and reached 96 mAU when 8 kGy were delivered. The HPLC analysis shows a complete degradation of the NAPH at absorbed dose of 10 kGy.

4.1.6. Adsorption test of NAPH by cellulose modified fibre

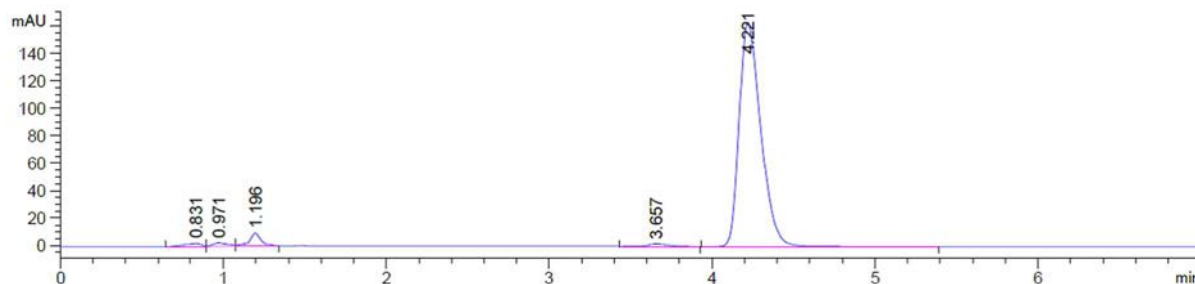

FIG. 6. Chromatographic profile of NAPH adsorbed by the modified cellulose fibres.

On Fig. 6, the decrease of the NAPH peak area is observed after adsorption by the modified cellulose fibres which pass from 21600 mAU to 2761 mAU when the modified cellulose fibres adsorbed about 87% of NAPH.

4.2. Effect of gamma radiation on the real effluent samples

In order to follow the radiation effect on the degradation of the organic compounds present in the effluents, we opted for analysis by HPLC before and after gamma irradiation by degradation of the FNT and NAPH and other organic pollutants which come from sewer treatment in first and then by adsorption by the cellulose modified fibre, to adsorb eventually the organic compounds residues and the radiolysis products.

4.2.1. Radiation effect on the pH of the effluent sample

The results showed that the radiation process decreases the pH of irradiated samples which passes from 8.14 at initial pH of the sample to 7.76 at absorbed dose of 10 kGy. The irradiation effect on pH of irradiated influent samples is shown in Fig. 7.

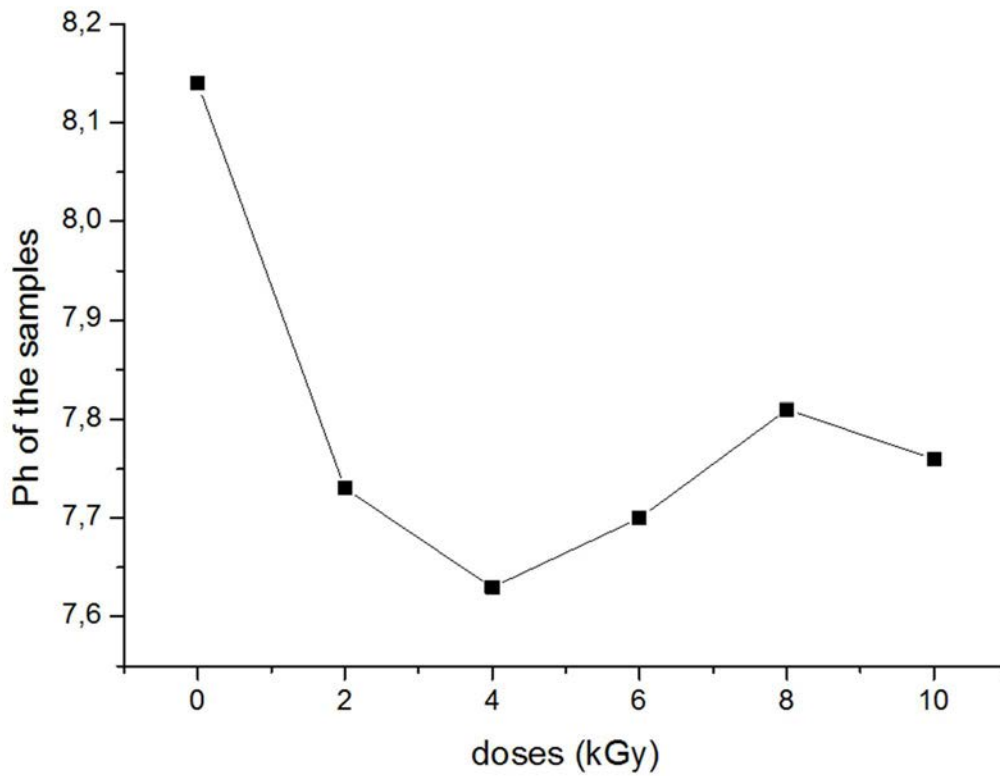

FIG. 7. Radiation effect on the pH of the effluent sample.

4.2.2. Analysis of non-irradiated and irradiated effluent sample by HPLC

4.3. HPLC analysis of effluent control sample

The Fig. 8 shows the chromatographic profile of the effluent sample analysed by HPLC after liquid extraction.

a)

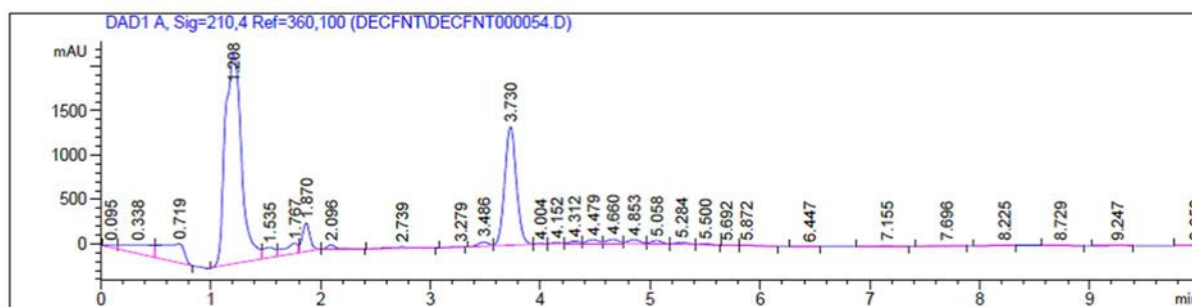

b)

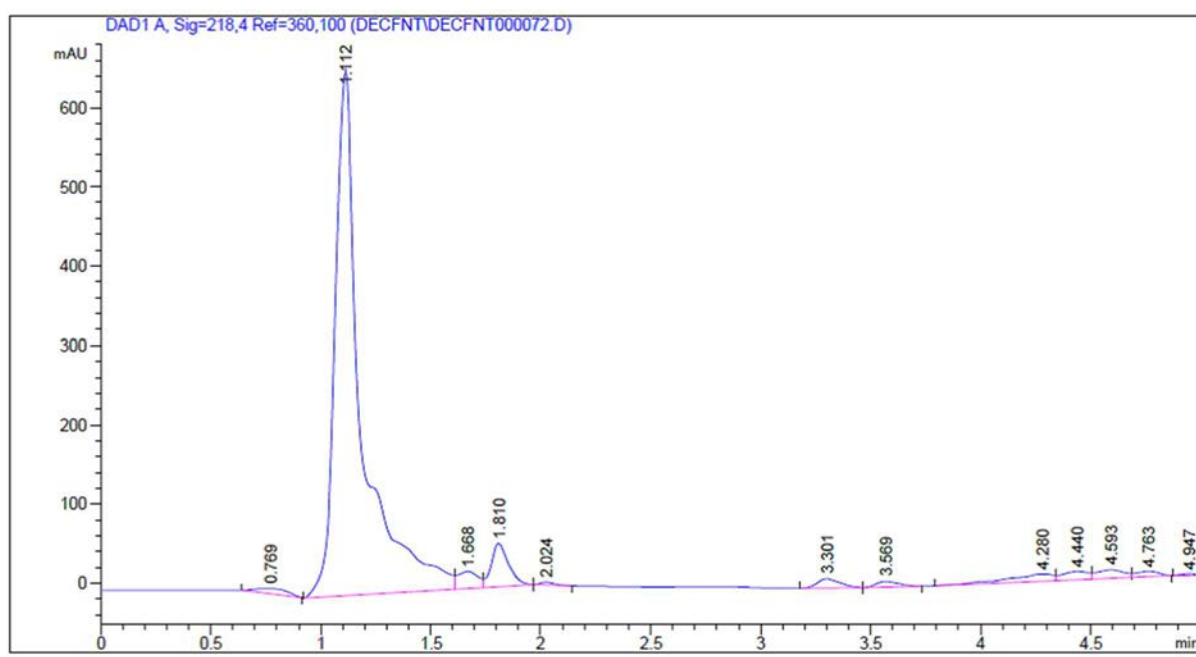

FIG. 8. HPLC analysis of FNT (a) and NAPH (b) traces present in the effluent control sample.

4.4. HPLC analysis of irradiated effluent sample

4.4.1. HPLC analysis of FNT in effluent sample

The Fig. 9 illustrates the radiation effect on the degradation of FNT traces present in the effluent sample, followed by the adsorption step using modified cellulose fibres, the adsorption rate of FNT was determined for the control and irradiated effluent sample.

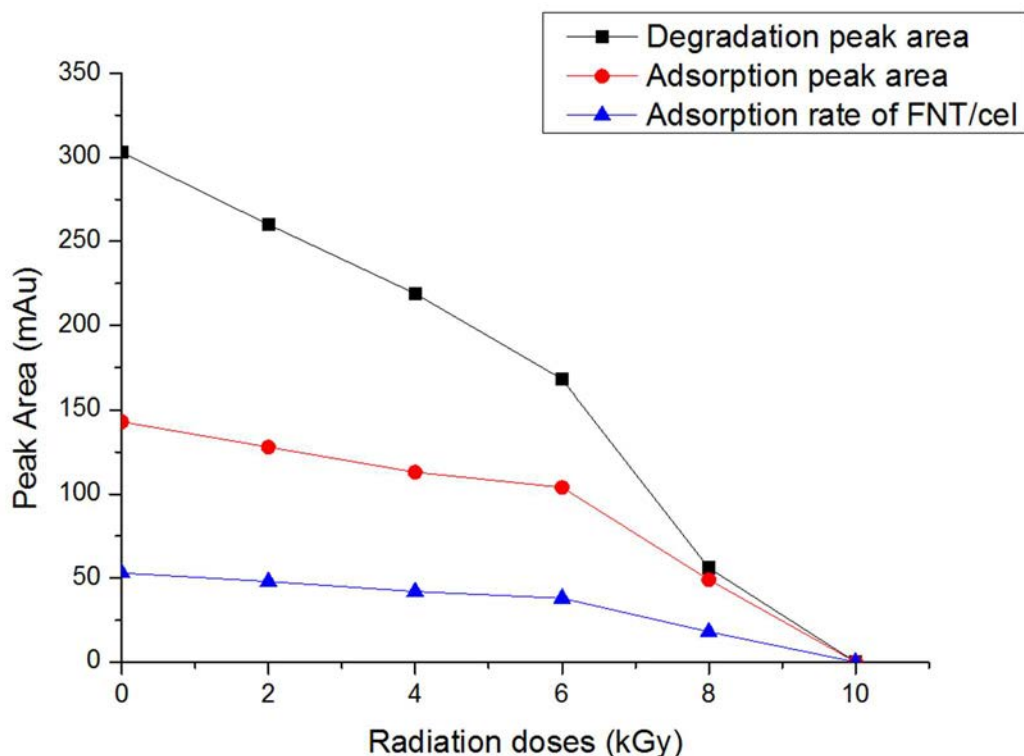

FIG. 9. Analysis of FNT in effluent sample by HPLC.

The analysis of effluent samples contaminated by POPs was performed by HPLC, which revealed the presence of traces of FNT where the peak area of the control sample was 303 mAU. Irradiation of the sample has degraded the molecule present in the medium, by reduction of the peak area which passed from 260 to 219 mAU at absorbed dose of 2 and 4 kGy and 168 to 56mAU at 6 and 8 kGy absorbed dose. A complete degradation occurred when 10 kGy were delivered. The same phenomenon was observed on these irradiated samples after the secondary treatment by adsorption using modified cellulose fibres. The adsorption rate was determined, 53% took place on control sample, a decline of the rate was observed which passed from 48 % to 42% at the doses of 2 and 4 kGy, from 38% to 18% at 6 kGy and 8kGy absorbed dose.

4.4.2. HPLC analysis of NAPH in the effluent sample

The Fig. 10 illustrates the radiation effect on the degradation of NAPH traces present in the effluent sample followed by the adsorption step to reduce the toxic molecule and by-products radio-formed. The adsorption rate of NAPH was determined for the control and irradiated effluent sample.

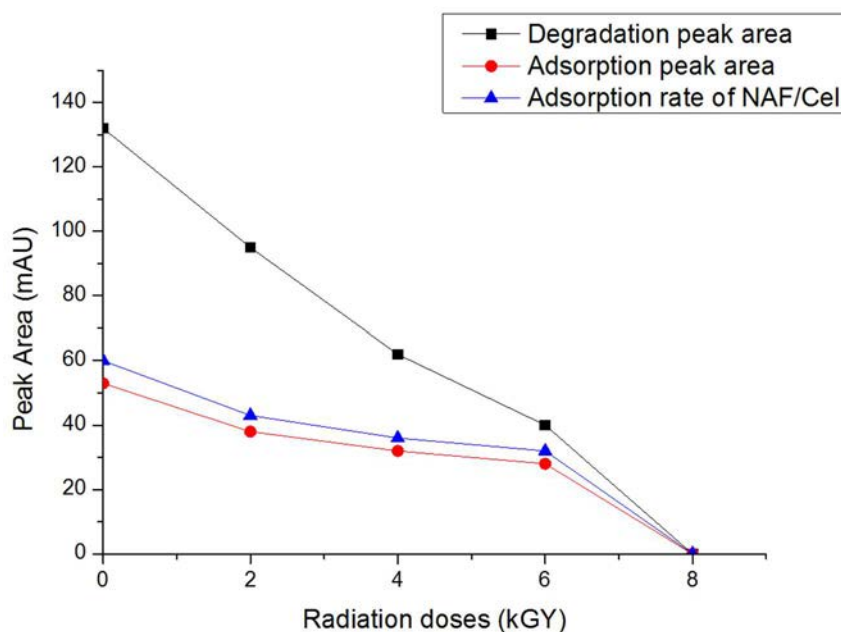

FIG. 10. Analysis of NAPH in effluent sample by HPLC.

The degradation of NAPH by gamma irradiation is observed in Fig. 10. The study of adsorption was carried out by HPLC. The results of the analysis of the control sample revealed the presence of traces of NAPH where the peak area of the control sample was 132 mAU. Depending on the radiation dose the degradation of the molecule has reduced the peak area which decreased from 95 to 62 mAU in respective dose of 2 and 4 kGy and reached 40 mAU at 6 kGy absorbed dose. The complete degradation of NAPH occurred at the dose of 8 kGy. The dose of 8 kGy allowed the complete degradation of the NAPH. The adsorption by modified cellulose fibres has reduced the area peak by 60% of the effluent control sample where the value passed from 53 mAU to 38 mAU at the dose of 2 kGy and reached 32 to 28 at absorbed dose of 4 and 6 kGy. An adsorption rate of 60% took place on control sample; a decline in the rate was observed from 43% to 36% at 2 and 4 kGy respectively and reached 28% when 6 kGy were delivered. The decrease of the adsorption rate is due to the decrease of the concentration of the molecule degraded by irradiation.

4.4.3. Effect of gamma radiation on the reduction of COD in the effluent

The Fig. 11 shows the COD of irradiated and non-irradiated effluent samples.

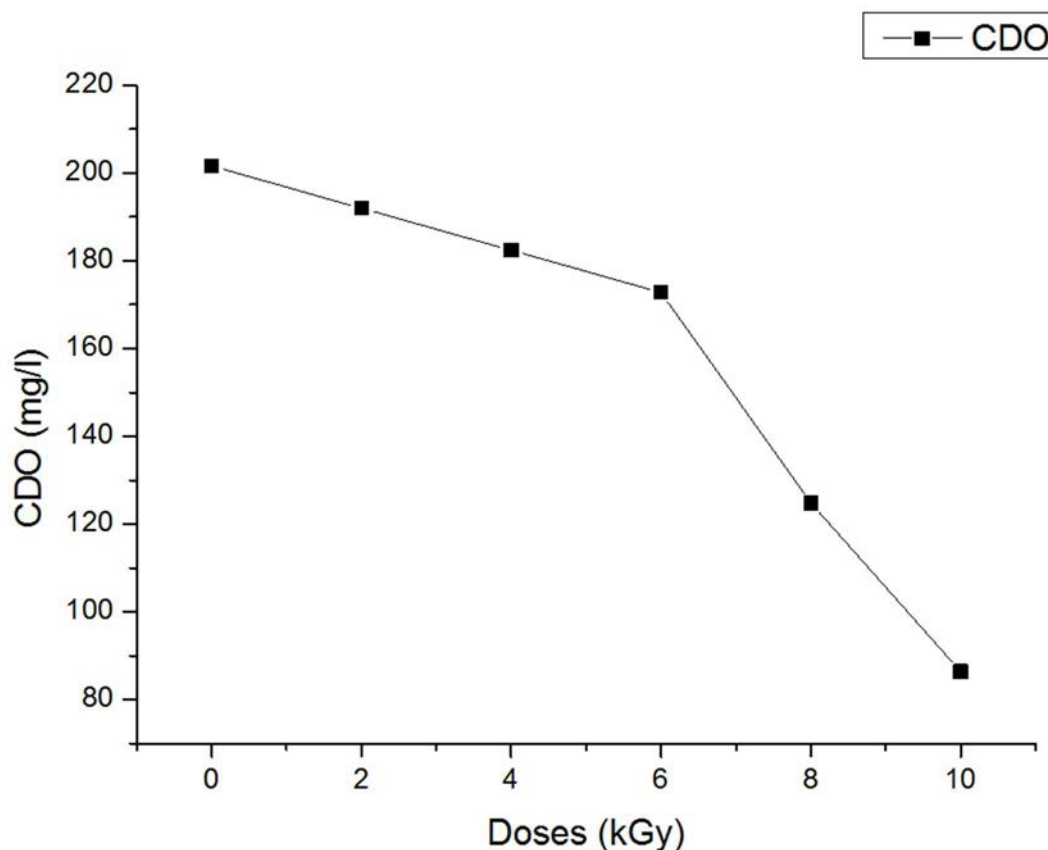

FIG. 11. COD Vs irradiation dose of effluent sample.

The irradiation of the effluent showed a reduction of chemical oxygen demand (COD). Fig. 11 shows that the COD for the control effluent sample, decreased from 202 mg/l to 87 mg/l with a percentage of reduction of 57% when 10 kGy doses were applied.

The reduction calculated using the formula: $\% \text{ COD} = [\text{COD}_i - \text{COD}_x / \text{COD}_i] \times 100$

Where COD_x is the value measured after a given dose and $\text{COD}_{\text{initial}}$ is the COD value for non-irradiated sample. The reduction in COD caused by radiation could be due to its direct and/ or indirect effect on the destruction of organic compound [Cooper, 2009]. The indirect effect is due to the free radicals produced by water radiolysis such as e_{aq}^- , H^\bullet , OH^\bullet , H_2O_2 .

5. SUMMARY

Concentrations of 150 mg/l for FNT and NAPH in aqueous solution were submitted to different absorbed doses of gamma radiation. The HPLC analysis showed that 99.7% of FNT were degraded at absorbed dose of 10 kGy. A complete degradation of NAPH was occurred at absorbed dose of 10 kGy.

An absorption by cellulose modified fibre was carried out on synthetic control solutions of FNT and NAPH where the rate of adsorption reached a respective value of 91% and 87%. According to Klemmet al.1998 [1], mechanical treatments increases accessibility.

The collected effluent samples taken from the purification plant, were irradiated at absorbed doses of 2, 4, 6, 8 and 10 kGy. The results show the decrease of the pH of the effluent sample

with the increase of the absorbed dose. Gamma irradiation allowed degradation of the organic compound present in the influent sample. The HPLC analysis has detected the presence of residues of FNT and NAPH in the control effluent sample where the reduction of the peaks area with the increase of absorbed doses was observed. A complete degradation of FNT and NAPH was occurred at 10 kGy and 8 kGy respectively.

The adsorption by modified cellulose has reduced the area peak of FNT and NAPH with respective adsorption rate of 53%–60% of the effluent control sample. A decline was observed when the adsorption rate reached 18% at 8 kGy for FNT and 28% at 6 kGy for the NAPH. The decrease of the adsorption rate is due to the decrease of the concentration of the molecule degraded by irradiation. Other organic pollutants can probably be adsorbed to obtain “cleaner water”.

As a complement, other studies also shown that irradiation of industrial wastewater in presence of air was destroying 57% of the COD at the dose of 10 kGy. In this case, the reduction of COD values could be related to the degradation of organic pollutant and its water solubility.

REFERENCES

- [1] CAMPOS, S.X., VIEIRA, E.M., CORDEIRO, P.J.M., RODRIGUES-FO, E., MURGU, M., Degradation of the herbicide 2,4-dichlorophenoxyacetic acid (2,4-D) dimethylamine salt by gamma radiation from cobalt-60 in aqueous solution containing humic acid. *Radiat.Phys.Chem.***68** (2003) 781–786.
- [2] DEMIR, H., TOP, A., BALKO, D., LKU, S.U., Dye adsorption behaviour of Luffa cylindrical fibres. *Journal of Hazardous Materials.***153**, (2007) 389–394.
- [3] ALILA, S., BOUFI, S., Removal of organic pollutants from water by modified cellulose fibre. *Industrial crops and products.***30**, (2009) 93–104.
- [4] TAKACS, E., MIRZADEH, H.B., WOJNA'ROVITS, L., BORSA, A.J., MIRZATAHERI, C.M., BENKE, B.N. Comparison of simultaneous and pre-irradiation grafting of N-vinylpyrrolidone to cotton cellulose. *Nuclear Instruments and Methods in Physics Research. B* **265** (2007) 217–220.
- [5] WOJNAROVITS, L., FOLDVARY, C.S.M., TAKACS, E., Radiation-induced grafting of cellulose for adsorption of hazardous water pollutants: A review. **79** (2010) 848–862.
- [6] BISPO, J.R.L., NAVICKIENE, S., DOREA, H.S., Method validation for SPE applied to determination of PAH in petroliferous industry effluent water. *American Journal of Analytical Chemistry.***2**, (2011) 971–978.
- [7] Ineris, (Institut National de l'environnement industriel et des risques). Fiche de données toxicologiques et environnementales des substances chimiques. Ministère de l'énergie, du développement durable et de la mer, **4**, (2011) 79 Dernière mise à jour (In French).
- [8] WEBER, J., KURKOVA, R., KLAN, P., HASALL, C.J., Photolytic degradation of methyl-parathion and fenitrothion in ice and water; Implication for cold environments. *Environmental Pollution* **157**, (2009) 3308–3313.
- [9] COOPER, W.J., NICKELSEN, M.G., TOBIEN, T., MINCHER, B.J., The electron beam process for waste treatment. In: *hazardous and radioactive waste treatment technologies handbook*, (2001) Chap. 5.5.1.
- [10] SPINUM, Evaluation des paramètres physiques et physico-chimiques qui influencent l'accessibilité de la cellulose. Thèse de l'école nationale supérieure des mines de Paris, (2010) 200.

TOXICITY ASSAYS APPLIED ON PHARMACEUTICALS SUBMITTED TO ELECTRON BEAM IRRADIATION

S.I. BORRELY¹, F. TOMINAGA¹, N. BOIANI¹, V.H. OGIHARA-SILVA¹ A.C. TEIXEIRA²
E. BARBIERI³

¹Instituto de Pesquisas Energeticas e Nucleares, IPEN-CNEN/SP, Sao Paulo

²Chemical Engineering Department - Engineering School, Universidade Sao Paulo

³Laboratório de Ecologia de Cananéia, Instituto de Pesca de Sao Paulo, Brazil

Abstract

Electron beam irradiation has been applied for three pharmaceuticals in water solution and in mixtures, as follow: Fluoxetine Hydrochloride (Prozac), Propranolol, Voltaren (sodium diclofenac), Fluoxetine Hydrochloride + Propranolol; Fluoxetine Hydrochloride + Voltaren and Fluoxetine Hydrochloride + raw sewage. Radiation benefits through toxicity removal were measured with *D. similis* and *V. fischeri*, although other living organisms were exposed to Prozac. From 5% up to 88% of toxicity removals were obtained for pharmaceutical and their mixtures when treated at 5 kGy, however the efficacy was very dependent on the biological specie. Higher than 90% of Fluoxetine was decomposed by 0.5 kGy but relatively low TOC removal was obtained even at 20 kGy.

1. OBJECTIVE OF THE RESEARCH

The objective of this research was to apply toxicity measurements for evaluating advanced treatment technologies, in order to confirm that no hazardous by-products may be generated when degrading pharmaceuticals. To determine the possible effects of electron beam irradiation for the detoxification of water solution and wastewaters contaminated by pharmaceuticals.

2. INTRODUCTION

Ionizing radiation has been applied to several classes of chemicals into wastewater and effluents in Brazil. Among the reported results there are sewage decontamination, anionic surfactant degradation and chemical and textile effluents as well [1-3]. A pilot scale system was designed for running irradiation of wastewater in a dynamic flux [4] during few years. Regarding to several classes of contaminants in natural waters there are pharmaceuticals, hormones and residues of health care products, such as detergents and soaps. The extensive use of pharmaceuticals led to the detection of them and their residues in waters and wastewaters in many countries [5]. The biological treatment systems are not designed for all types of medicines and some of them are supposed to be recalcitrant [6, 7]. Ozone combined to biological process was studied by Lester et al [8]. Ionizing radiation may be feasible for pharmaceutical decomposition as shown by Csay et al [9], Homlok, et al [10], and Ogihara-Silva [11]. The biological negative effects of fluoxetine in the waters have been well demonstrated [12, 7, 13].

2.1. Pharmaceuticals in wastewaters and Brazilian market

The use and production of pharmaceuticals in the world is directly related to the environmental contamination by them. The top ten preferred substances (pharmaceuticals) in Brazil during the last five years were listed in Table 1. Though this list we have selected some of them for irradiation and toxicity studies. The selection of Fluoxetine Hydrochloride was related to the low biodegradability and reported negative effects to biota [11]. Brazilian

pharmaceutical market registered for antidepressant drugs a substantial growth from 2005–2009 totalling US\$ 976 million; whereas the prescriptions for Metilfenidato (stimulant-hyperactivity) increased 1020% in the last 4 years [14].

TABLE 1. THE TOP TEN USED PHARMACEUTICALS IN BRAZIL

2010	2011
Dipirona (analgesic, antipyretic - AA)	Dipirona sódica (AA)
Paracetamol (acetaminophen - AA)	Losartana potássica (HP)
Amoxicilina (clavulanate ac. - antibiotic)	Paracetamol (AA)
Nimesulida (metanesulfonamide - AAA)	Atenolol (HP)
Atenolol (tenormin – Hipertension - HP)	Citrato sildenafil (sexual dysfunction)
Cloridrato de Metformina (anti-hyperglycaemic)	Nimesulida (AAA)
Albendazol (anti-helminthic, AH)	Hidroclorotiazida (thiazide – diuretic)
Omeprazol (gastritis)	Albendazol (AH)
Potassium Diclofenac (anti-inflammatory) Voltaren	Simeticona (gas)
Simeticona (gas)	Levotiroxina (thyroid hormone)

From Table 1 analysis it is possible to consider the wide types of pharmaceuticals and chemicals present in effluents from the pharmaceutical industry and in receiving wastewaters. The main importance of toxicity measurements is in great part due to the possibility to identify the whole effects of an effluent even if its content is not known.

3. MATERIALS AND METHODS

Fluoxetine Hydrochloride, Propranolol and Voltaren (potassium diclofenac) have been submitted to EB irradiation and to toxicity measurements. Radiation effects onto toxicity of pharmaceutical in water solution and some mixtures were determined. Samples identification and composition were presented in Table 2. The Fluoxetine in water solutions were prepared using: a) Fluoxetine (Divis Pharmaceuticals Pvt. Ltda, 98.78%) for chemical analysis, irradiation and toxicity. In the following steps the commercial product (Prozac) was also studied and irradiated. The mixture of Prozac and domestic sewage for irradiation and toxicity measurements was also carried out.

Further studies included commercial pills of Propranolol, Voltaren and their mixtures as pointed out in Table 2.

TABLE .2. PHARMACEUTICALS IN WATER SOLUTION AND THEIR MIXTURES

Drug in water solution	Mixture
Fluoxetine Hydrochloride (FH) and Prozac (10ppm)	Prozac + raw sewage (50% / 50%)
Voltaren (anti-inflammatory) – 100 ppm	Prozac + Voltaren (50% / 50%)
Propranolol (highpressure - Prop) – 80ppm	Prozac + Propranolol (50% / 50%)

The Fluoxetine and Diclofenac solutions were prepared at concentrations of 100 and 10 mgL⁻¹, respectively. The preparation of the mixture was carried out in a 50/50 ratio. Each drug capsule of Diclofenac contains 50mg of diclofenac in its formulation besides some excipients (silicon dioxide, microcrystalline cellulose, lactose, magnesium stearate, povidone starch, macrogol, polysorbate 80, talc, yellow ferric oxide and red ferric oxide, sodium starch glycolate, polymer methacrylate, titanium dioxide, and hypromellose). Diclofenac’s solubility

in water is $19 \text{ mg}\cdot\text{mL}^{-1}$. The Fluoxetine drug capsule contains 20 mg of fluoxetine hydrochloride in its formulation, besides some excipients (aerosil, sodium lauryl sulphate, micro-crystalline cellulose and maize starch). The FH solubility is $14 \text{ mg}\cdot\text{mL}^{-1}$, in water.

The mixture of Propranolol and Fluoxetine was carried out in a 50/50 ratio too. The propranolol solution was prepared at concentration of $80 \text{ mg}\cdot\text{L}^{-1}$, where each tablet of propranolol contains 80mg hydrochloride propranolol and the excipients, stearic acid, lactose, silicon dioxide, microcrystalline cellulose and magnesium stearate.

3.1.Toxicity assays

Hyalella azteca amphipod and *P. pandaliformis* shrimp were the new biological assays applied for the evaluation of toxicity of Fluoxetine Hydrochloride, FH among other assays (Table 3).

Propranolol and Fluoxetine were exposed to *H. azteca* and the listed mixtures in Table 2 were evaluated for *Daphnia similis* and for *Vibrio fischeri*, before and after irradiations. The methodology adopted for toxicity assays was ABNT Brazilian standard methods. The *daphnias* were raised at proper Laboratory and several concentrations of target compound were exposed to *D. similis* for 48 hours. The same for *H. azteca* (96h length of exposure). The *V. fischeri* bioluminescence was measured at Microbics 500[®] analyser and four concentrations of studied samples were measured. The lost luminescence, after 15 minutes exposition, was proportional to the pharmaceutical concentrations. The EC₅₀ numbers were calculated through linear regression analysis [15, 16]. EC₅₀ is the average effective lethal concentration, or assay end-point, meaning the concentration at which 50% of the individuals reacted after a specified length of exposure. Once EC₅₀ numbers are inversely proportional parameter, the transformation into Toxic Units (TU) is suitable for the calculations of treatment efficacy

H. azteca and *P. pandaliformis* shrimp were raised at laboratory at standard conditions, the solutions for the biological assays were prepared with natural water and surviving and behaviour were the observed end-points.

From the results, for instance immobility of *D.similis* and the sample concentrations which were measured it is obtained the EC₅₀. To transform EC₅₀ into a direct number it is possible to calculate the Toxic Units, TU ($\text{TU} = 100/\text{EC}_{50}$).

3.2.EB Irradiation

Electron beam irradiation was performed at a Dynamitron[®] Electron Beam Accelerator, with fixed parameters: 37.5 kW power and 1.4 MeV energy. Radiation doses ranged from 0.5 to 20.0 kGy by varying the electric current (batch scale).

3.2.1. Chemical analysis

3.2.1.1. Chromatographic conditions

Fluoxetine concentrations were determined by ultra-fast liquid chromatographic (UFLC) analysis using a Shimadzu (LC 20AD), equipped with a UV-Visible (SPD 20A), fluorescence (RF-10Ax1) detectors and a C₁₈ column (Kinetex 5 μm Phenomenex, 150 \times 4.6 mm). The oven temperature and sample injection volume were 40.0 $^{\circ}\text{C}$ and 50.0 μL , respectively. The eluents were (A) acetic acid 1% and (B) acetonitrile at 70:30 ratio and 1.00 mL min^{-1} flow rate. For UV-Vis analysis, the wavelength for fluoxetine detection was 226 nm. For fluorescence

analysis, the emission and excitation detection wavelengths of fluoxetine were 290 nm and 230 nm, respectively.

3.2.1.2. Total organic carbon analysis

The total organic carbon was measured at Shimadzu TOC- 5000A analyser. The TOC was determined indirectly by the difference between total carbon content of the sample (TC) and inorganic carbon (IC) content.

4. RESULTS AND DISCUSSION

The toxicity of fluoxetine hydrochloride to several living-organisms was presented in Table 3. After irradiation the CE50 values were transformed to toxic units. Fig. 1 is showing the radiation effects onto toxicity of FH (Prozac®).

Regarding the toxicity obtained for the mixture of products after irradiation (Figs. 1 and 2). The general results on the efficacy of radiation to all studied combinations were presented in Table 4.

TABLE 3. EFFECTIVE LETHAL CONCENTRATIONS OF FLUOXETINE (FH) TO FOUR AQUATIC LIVING-ORGANISMS (WATER SOLUTION)

Living-organism	CE50 (mg L ⁻¹)
<i>Hyalella azteca</i> (amphipod), 96 h	0.59 ± 0.20 (96 h)*
<i>Vibrio fischeri</i> (luminescent bacteria) 15 min	1.15 ± 0.06 (15 min)*
<i>Daphnia similis</i> (microcrustacea), 48 h	1.28 ± 0.30 (48h)*
<i>P. pandaliformis</i> (crustacean, shrimp), 96 h	35.47 (48h)*

(*exposure time)

According to the CE50 values in Table 3, very similar sensitivity was noted for *H. azteca*, *V. fischeri* and *D. similis* to FH water solution. Nonetheless, after irradiation *D. similis* assays resulted in lower toxic units, compared to *V. fischeri* data (Fig. 1).

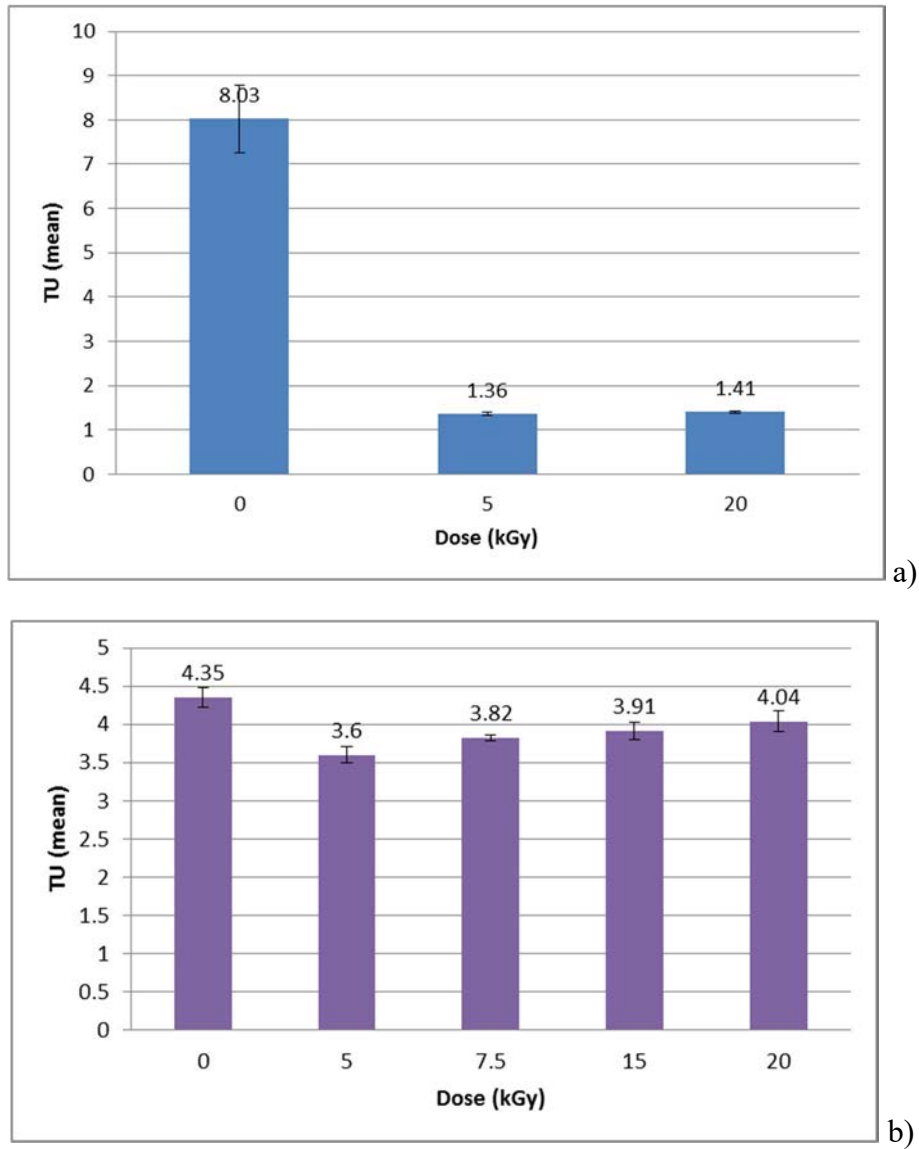

FIG. 1. (a) Toxic Unit obtained for *Daphnia similis* (a) and (b) *Vibrio fischeri*, when exposed to Prozac® versus dose (kGy).

After determining the toxicity of fluoxetine in water solution to several organisms (Table 3), the samples were irradiated and comparisons between treatments were performed with two assays (*D. similis* and *V. fischeri*). EB irradiation was carried out for these three types of samples (fluoxetine in water solution); untreated domestic sewage; a 50% mixture of both (Table 4). The toxic units for untreated samples varied from 4.44 (FH), 6.11 (untreated raw sewage) and 6.23 (mixture). No additive effect was observed once the untreated sewage and mixture values were very close. After irradiation at 2.5 kGy up to 7.5 kGy the toxicity was reduced (> 20%), *V. fischeri* assay.

TABLE 4. RADIATION EFFECTS ON TOXICITY FOR SAMPLES TREATED BY RADIATION (V. FISCHERI)

Samples	Doses (kGy)	EC50 (%) confidence interval	and	TU	Efficiency (%)
F.H. (Exp. 3.1)	0	22.54 (9.25–54.92)		4.44	-
	2.5	27.13 (17.72–41.52)		3.69	16.92
	5.0	22.87 (9.07–57.65)		4.37	1.44
	7.5	29.96 (16.17–55.51)		3.34	24.77
Untreated sewage (Exp. 3.1)	0	16.36 (6.36–42.05)		6.11	-
	2.5	18.83 (5.38–65.90)		5.31	13.12
DS	5.0	20.58 (5.97–70.93)		4.86	20.51
	7.5	20.88 (6.39–68.22)		4.79	21.65
Mixture (Exp. 3.1)	0	16.05 (6.92–37.22)		6.23	-
MFS	2.5	19.40 (5.61–67.00)		5.15	17.27
	5.0	21.75 (9.10–50.03)		4.60	26.21
	7.5	19.82 (5.58–70.36)		5.05	19.02

The toxic units for the mixture of fluoxetine + voltaren (Fig. 2) were reduced by radiation, mainly at 5 kGy (*V. fischeri*). However, the efficacy of radiation for toxicity removal was only 5.33% when measured with *D. similis*.

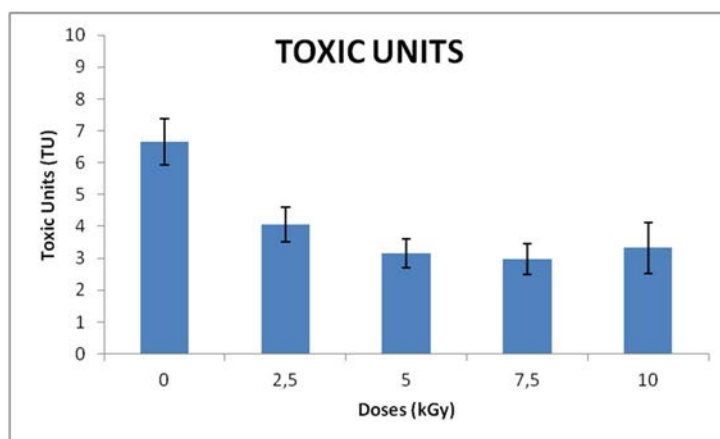

FIG. 2. Toxic units of mixture Fluoxetine Hydrochloride + Voltaren versus radiation dose (*Vibrio fischeri* – 15 min).

Relatively low effects of radiation were achieved by total organic carbon measurements (Fig. 3), even after the main compound degradation was obtained.

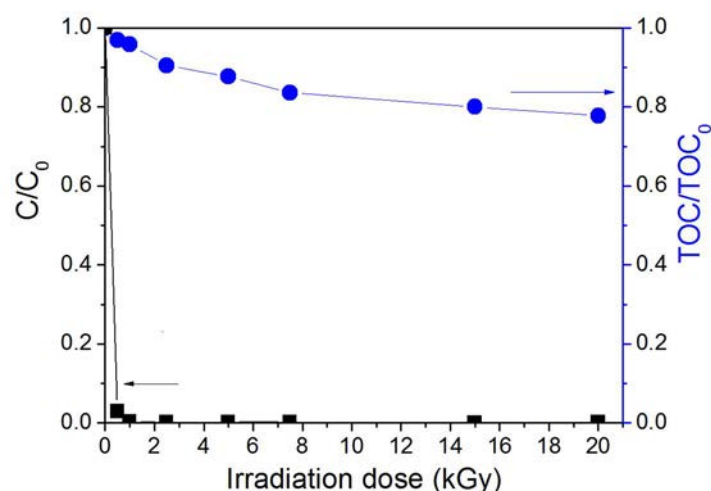

FIG. 3. TOC versus dose as degradation efficacy of EB irradiation.

The radiation processing of the mixture (Fluoxetine and Voltaren), the reducing toxic units indicated 55% of removal for *V. fischeri*, and 11% removal for *D. similis* (5 kGy). Toxicity was reduced for all three studied products and their mixtures treated with 5 kGy and <5 kGy.

TABLE 5. TOXICITY REMOVAL (%) BY EB IRRADIATION OF PHARMACEUTICALS AND THEIR MIXTURES AT 5 kGy

Sample	<i>D. similis</i> (48h)	<i>V. fischeri</i> (15 min)
Prozac® - FH	88.51	17.26
Voltaren (Diclofenac – DF)	5.33	52.03
Propranolol – PP	79.95	92.76
Pharmaceuticals Mixture		
FH + raw sewage	79.30	21.81
FH + DF	13.22	55.06
FH + PP	-	25.30

The degradation of these products in water solution (not mixture) was >90% at 0.5 kGy (FH and DF)

FH: 10 ppm (mixture 50/50 percentage); DF–100 ppm (mixture 50/50, percentage)

PP: 80 ppm (mixture 50/50, percentage)

5. SUMMARY

Radiation effects on pharmaceuticals resulted in less toxicity at doses lower than 5.0 kGy. *Daphnia similis* assays were more suitable for the pharmaceutical irradiated mixtures. Pharmaceuticals degradation >90% was obtained at lower doses (fluoxetine and propranolol). Concerning textile dyes 2.5 kGy and 5 kGy were very effective for reducing colour and toxicity for most studied effluents, except for one of them which required higher doses. Reactive dyes used in colouring cotton may result at vinylsulphone, sulphatoethylsulphone and hidroxiethylsulphone forms, among several other chemicals. Blue 222 coloured effluent was decoloured at 2.5 kGy and reused for cotton dyeing (laboratory scale). All experiments were performed at 1.4 MeV fixed energy at a Dynamitron electron beam accelerator.

ACKNOWLEDGEMENT

We would like to thank International Atomic Energy Agency (Contract RC 16465) and the Brazilian Council for Research and Development, CNPq.

REFERENCES

- [1] BORRELY, S.I., DEL MASTRO, N.L., SAMPA, M.H.O., Improvement of municipal wastewaters by electron beam accelerator in Brazil. *Radiat. Phys. Chem.*, **52**, (1998) 333–337.
- [2] ROMANELLI, M.F., MORAES, M.C.F., VILLAVICENCIO, A.L., BORRELY, S.I., Evaluation of toxicity reduction of sodium dodecyl sulphate submitted to electron beam radiation. *Radiat. Phys. Chem.*, **71**, (2004) 409–411.
- [3] DUARTE, C.L., GERALDO, L.L., JUNIOR, O.A.P., BORRELY, S.I., SATO, I.M., SAMPA, M.H.O. Treatment of effluents from petroleum production by electron beam irradiation. *Radiat. Phys. Chem.*, **71**, (2004) 443–447.
- [4] RELA, P.R., SAMPA, M.H.O., DUARTE, C.L., COSTA, F.E., SCIANI, V., Development of up-flow irradiation device for electron beam wastewater treatment. *Radiat. Phys. Chem.* **57**, (2000) 657–660.
- [5] GAO, P., DING, Y., LI, H., XAGORARAKI, I., Occurrence of pharmaceuticals in a municipal wastewater treatment plant: Mass balance and removal processes. *Chemosphere*, **88**, (2012) p. 17–24.
- [6] HERBERER, T., Tracking persistent pharmaceutical residues from municipal sewage to drinking water. *Journal of Hydrology*, **266**, (2002) p. 175–189,
- [7] BORRELY, S.I., CAMINADA, S.M.L., PONEZI, A.N., SANTOS, D.R., OGIHARA SILVA, V.H., Contaminação das águas por resíduos de medicamentos: ênfase ao cloridrato de fluoxetina. *O mundo da saúde*, **36 (4)**, (2012) p.556–563.
- [8] LESTER, Y., MAMANE, H., ZUCKER, I., AVISAR, D., Treating wastewater from a pharmaceutical formulation facility by biological process and ozone. *Water Research*, **47**, (2013) p. 4349–4356.
- [9] CSAY, T., RÁCZ, G., TAKÁCS, E., WOJNÁROVITS, L., Radiation induced degradation of pharmaceutical residues in water: Chloramphenicol. *Radiat. Phys. Chem.*, **81**, (2012) 1489–1494.
- [10] HOMLOK, R., TAKÁCS, E., WOJNÁROVITS, L., Degradation of organic molecules in advanced oxidation processes: Relation between chemical structure and degradability. *Chemosphere*, **91**, (2013) 383–389.
- [11] SILVA, V.H.O., Avaliação da toxicidade e da degradação do fármaco cloridrato de fluoxetina, em solução aquosa e em mistura com esgoto doméstico, por irradiação com feixe de elétrons (2014) (Instituto de Pesquisas Energéticas e Nucleares – Dissertação Mestrado).
- [12] LAZZARA, R., BLAZQUEZ, M., PORTE, C., BARATA, C., Low environmental levels of fluoxetine induce spawning and changes in endogenous estradiols levels in zebra mussel *D. polymorpha*, *Aquatic toxicology*, **106–107**, (2012) p.123–130.
- [13] GONZALEZ-REY, M., BEBBIANO, M.J., Does selective serotonin reuptake inhibitor (SSRI) fluoxetine affects mussel *Mytilus galloprovincialis*? *Environmental Pollution*, **173**, (2013) p.200–209.
- [14] TUBINO, N., Quanto vale a loucura industrializada? *Carta Maior Journal* (2014).
- [15] Associação Brasileira de Normas Técnicas.(ABNT) Ecotoxicologia aquática – Determinação do efeito inibitório de amostras de água sobre a emissão de luz de *Vibrio fischeri* (Ensaio de bactéria luminescente) Parte 3: Método utilizando bactérias liofilizadas. Rio de Janeiro: ABNT, (2012) (NBR 15411–3).
- [16] Associação Brasileira de Normas Técnicas (ABNT) Ecotoxicologia Aquática – Toxicidade aguda – Método de ensaio com *Daphnia spp* (Crustacea, Cladocera). Rio de Janeiro: ABNT (2009). (NBR 12713).

DEGRADATION OF 3-CHLORO-4-HYDROXYBENZOIC ACID IN BIOLOGICAL TREATED EFFLUENT BY GAMMA IRRADIATION

L. CHU, J.L. WANG, Y. LIU

Institute of Nuclear and New Energy Technology, Tsinghua University
Beijing, 100084
China

Abstract

Gamma irradiation-induced degradation of a chlorinated organic compound, 3-chloro-4-hydroxybenzoic acid (CHBA) in treated effluent was studied and its performance was compared to that in pure water. Results showed that CHBA was degraded effectively using gamma irradiation and the removal of CHBA followed the pseudo first-order kinetic reaction. The rate constant in the treated effluent was 1.7–3.5 times lower than that in pure water. The radiolytic yield, G values of CHBA decreased with increasing the absorbed dose and it was lower in the treated effluent. The CHBA degradation is favoured at acidic condition and decreased at neutral and alkaline pH. Both of Fe^{2+} and H_2O_2 additives exhibited an obvious synergetic effect on the degradation of CHBA in the treated effluent following gamma irradiation and the removal efficiencies of CHBA and TOC increased by 11–12% and 4–10%, respectively. The degradation mechanism of CHBA using gamma irradiation was ascribed to the oxidation by $\cdot\text{OH}$ and reduction by e_{aq}^- and $\text{H}\cdot$ radicals. As exposed to gamma irradiation, dechlorination takes place rapidly and combines with the oxidation and cleavage of the aromatic ring, producing chloride ions, small carboxylic acids and acetaldehyde into the solution.

1. OBJECTIVE OF THE RESEARCH

To find the effects of pH values and initial CHBA concentrations; To compare the extent of CHBA removal and mineralization in the presence of Fe^{2+} , H_2O_2 , CeO_2 nanoparticles and carbon nanotubes, respectively during gamma irradiation; To study the mechanism of CHBA degradation by analysing the intermediates, carboxylic acids and chloride ions following gamma irradiation.

2. INTRODUCTION

The irradiation technology, using ^{60}Co -gamma-irradiation and electron beam accelerator, has been a promising approach for degrading refractory organic pollutants in aqueous solution and is drawing considerable attention in many countries. Ionizing radiation treatment, as an advanced oxidation process (AOP), is advantageous as no additional chemicals are added, no residual substances are generated and the recalcitrant compounds could be degraded by reactive species such as hydroxyl radicals, hydrated electron and hydrogen atoms formed during water radiolysis [1].

Studies have shown that ionizing radiation is effective in degrading phenolic [2, 3] and chlorophenolic [4, 5] compounds, herbicides [5, 6], and pharmaceutical and personal care products (PPCPs) [7-10] in aqueous solution. Factors hindering the application of ionizing irradiation involve the high cost, public safety concerns associated with the use of radioisotopes owing to little knowledge on this technology, and incomplete mineralization [11-13]. In many cases, ionizing radiation for complete mineralization of the organic pollutants into carbon dioxide, through the intermediate carboxylic acids such as formic, acetic and butyric acid, and aldehydes, etc. needs extremely high absorbed doses. Moreover,

most of the studies related to pollutants degradation by ionizing irradiation has been focused on pure aqueous solution (deionized or distilled water). Limited information [14, 15] is available about irradiation-induced degradation in real receiving waters such as groundwater and treated effluent from biological treatment, which is useful for potential practical application.

The composition of the real aqueous solution is complex. The residue dissolved organic substances might compete with the target contaminant for reactive species formed during gamma irradiation [16]. In addition, some inorganic ions such as NO_3^- , CO_3^{2-} and HCO_3^- scavenge the reactive chemical species produced during irradiation and some natural organics in the water matrix might accelerate or decelerate the degradation of the target contaminant [17, 18]. Zheng et al. [19] documented that the degradation efficiency of ibuprofen by gamma irradiation was increased in the presence of humic acid. Kimura [9] studied the removal of some pharmaceuticals in wastewater using activated sludge processes followed by gamma irradiation. They found that the non-biodegradable compounds, including carbamazepine, ketoprofen, mefenamic acid, clofibracacid, and diclofenac in wastewater (5 $\mu\text{mol/L}$), were decomposed completely by gamma irradiation at an absorbed dose of 2.0 kGy. Homlok et al. [20] reported that diclofenac at $\mu\text{g/L}$ level in the treated effluent could be removed completely with microorganisms inactivation at an absorbed dose of 1.0 kGy. The studies by Sanchez-Polo et al [21] demonstrated that the degradation rate of metronidazole was lower in groundwater and surface water than in ultrapure water and greatly lower in wastewater by gamma irradiation. The dose required for 50% degradation of metronidazole (150 $\mu\text{mol/L}$) was 433 Gy in ultrapure water, 630 kGy in groundwater and surface water and 770 Gy in wastewater, respectively. Similar results were obtained for degradation of cytarabine in the four types of water matrix by gamma irradiation [16].

This study was focused on gamma irradiation-induced decomposition of 3-chloro-4-hydroxybenzoic acid (CHBA) in treated effluent and the results were compared with those obtained in pure water. CHBA was chosen as the target contaminant because it represents an important organic pharmaceutical intermediate. As a chlorinated aromatic compound, CHBA has drawn increasingly environmental concern due to its toxicity. Experiments were conducted to compare the extent of CHBA removal and mineralization in the presence of Fe^{2+} , H_2O_2 , CeO_2 nanoparticles and carbon nanotubes, respectively during gamma irradiation. Factors affecting CHBA degradation such as pH values and initial CHBA concentrations were investigated. The mechanism of CHBA degradation was proposed by analysing the intermediates, carboxylic acids and chloride ions following gamma irradiation. These findings could be helpful to provide useful information for practical application of ionizing irradiation and for determining the favourable catalytic irradiation process to enhance the degradation of organic pollutants.

3. MATERIALS AND METHODS

3.1. Chemicals and reagents

CHBA was supplied by Tokyo Chemical Industry Company with a purity of above 99.5% and used as received. The reagents used in the study involving hydrochloric acid, sodium hydroxide, hydrogen peroxide, and used for the preparation of CeO_2 nanoparticles were high-purity analytical grade. Carbon nanotubes were obtained from the Chengdu Institute of Organic Chemistry, Chinese Academy of Science. CeO_2 nanoparticles were synthesized through the co-precipitation of Ce^{2+} and Ce^{3+} in basic solutions in argon by Massart's method

as described in our previous studies [22]. The molecular structure of CHBA was as Fig. 1 shows:

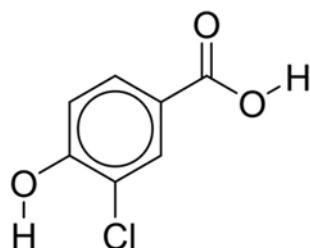

FIG.1. The molecular structure of CHBA.

3.2. Sample preparation and irradiation

The CHBA stock solution (200 mg/L) was prepared by dissolving CHBA in deionized water and stored in a refrigerator. For gamma radiolysis, the CHBA-containing aqueous samples were prepared by adding CHBA stock solution into treated effluent or deionized water, respectively and mixed adequately. pH adjustment was made by adding hydrogen chlorate acid or sodium hydroxide before irradiation. To evaluate the enhancement of gamma irradiation-induced degradation, a certain amount of Fe^{2+} , H_2O_2 , CeO_2 and carbon nanotubes were added to the CHBA-contaminated aqueous solution and mixed adequately, respectively before irradiation. The treated effluent was taken from the secondary setting tank of a local Municipal Wastewater Treatment Plant in Beijing and was filtered using $0.45\mu\text{m}$ filters before use. It contains 2.7 mg TOC/L, 192 mg HCO_3^- /L, 51.8 mg NO_3^- /L and 101 mg Cl^- /L.

Gamma irradiation was performed in a ^{60}Co source located at the Institute of Nuclear and New Energy Technology in Tsinghua University. The radioactivity is 3.6×10^{14} Bq. Samples (around 40 mL each) were preserved in 50 mL airtight glass vessels, which were then placed in the irradiation field near the centre from the source with a dose rate of around 240.2 Gy/min. The desired series of absorbed doses were achieved by adjusting the irradiation time. All the irradiation experiments were performed at least twice at ambient temperature of 22–25°C and the given results represent the mean values.

The radiation chemical yield (G-value) refers to the number of molecules formed or decomposed in solution when 100 eV of energy is absorbed. It is calculated as follows (Kongmany et al., 2014):

$$G = (C_0 - C) \times 6.023 \times 10^{23} / (D \times 6.24 \times 10^{16}) \quad (1)$$

Where C_0 (mol/L) is the initial CHBA concentration; C (mol/L) is the CHBA concentration at an absorbed dose of D (Gy); 6.023×10^{23} is the Avogadro constant (molecules/mol); 6.24×10^{16} is conversion constant from Gy to 100 eV/L.

3.3. Analytical methods

CHBA concentration before and after irradiation was determined using high-performance liquid chromatography (HPLC, Agilent 1200 Series, USA) with a diode array detector and a reversed-phase column (XDB-C18, 4.6×150 mm). The detection wavelength is 254 nm. A mixture of methanol, water and acetic acid at a ratio of 30:68.5:1.5 was used as eluent with a flow rate of 1.0 mL/min. The retention time of CHBA was 7.9 min. TOC was evaluated using

a TOC analyser (multi N/C 2100, Analytik Jena, Germany). PH was measured by a pH meter (Thermo Orion model 8103BN). UV-Vis spectrum of samples following gamma irradiation was analysed using a UV-Vis spectrophotometer (Lambda 25, PerkinElmer, America).

Chloride ion and carboxylic acids such as formic acid and acetic acid produced from CHBA decomposition following gamma irradiation were evaluated by an ion chromatograph (Dionex ICS 2100, Thermo Fisher, America) equipped with an analytical column (Dionex IonPac AS19, 4×250 mm), a guard column (IonPac AG19, 4×50 mm) and a DS6 conductive detector. The mobile phase was sodium hydroxide (30 mmol/L) with a flow rate of 1.0 mL/min. The intermediates formed by gamma irradiation were identified by GC-MS analyser (Agilent 7890A/5975C, America) equipped with an OV-101 GC capillary column (50 m×0.25 mm×0.25 m) and an MS detector which was operated at electron ionization of 70 eV and ion source temperature of 200°C. The carrier gas was helium with a flow rate of 0.6 mL/min and injection temperature was 250°C. The temperature program was performed by retaining at 50°C for 4 min and then increasing to 220°C at an increment of 10°C /min. Before analysis, the aqueous samples were acidified and the organic substances were extracted using an automatic solid phase extraction apparatus (Reeko, China).

4. RESULTS AND DISCUSSION

4.1. Effects of gamma irradiation on the degradation of CHBA in treated effluent and pure water

4.1.1. Effect of solution pH and water matrix

Fig. 2 shows the efficacy of CHBA degradation in treated effluent and pure water solutions under acidic, neutral and alkaline conditions following gamma irradiation. With the increase of the absorbed doses, the CHBA concentrations in the solution decreased. The removal of CHBA during gamma irradiation could be described by the pseudo first-order kinetic reaction.

$$-\ln(C/C_0) = kD \quad (2)$$

Where C (mg/L) is the concentration of CHBA at a dose of D (kGy), C_0 is the initial CHBA concentration (mg/L), and k is the rate constant (/kGy).

As shown in Fig. 2, the pH value has a great effect on CHBA degradation by gamma irradiation. Regardless of the water matrix used, the degradation of CHBA was favoured at acidic conditions but decreased at neutral and alkaline conditions. This was more pronounced in the treat effluent than in pure water. The dose for 99% of CHBA removal was 0.5 kGy at acidic and neutral pH and 1.0 kGy at alkaline pH for pure water, while it was 1.0, 1.5 and 2.0 kGy at the acidic, neutral and alkaline pH, respectively for treated effluent. The rate constant k of CHBA degradation in the acidic, neutral and alkaline pure water was 6.3, 5.3 and 4.5/kGy, respectively and decreased to 3.8, 2.4 and 1.3 /kGy in treated effluent. Similar results were found by other researchers [3, 23, 19].

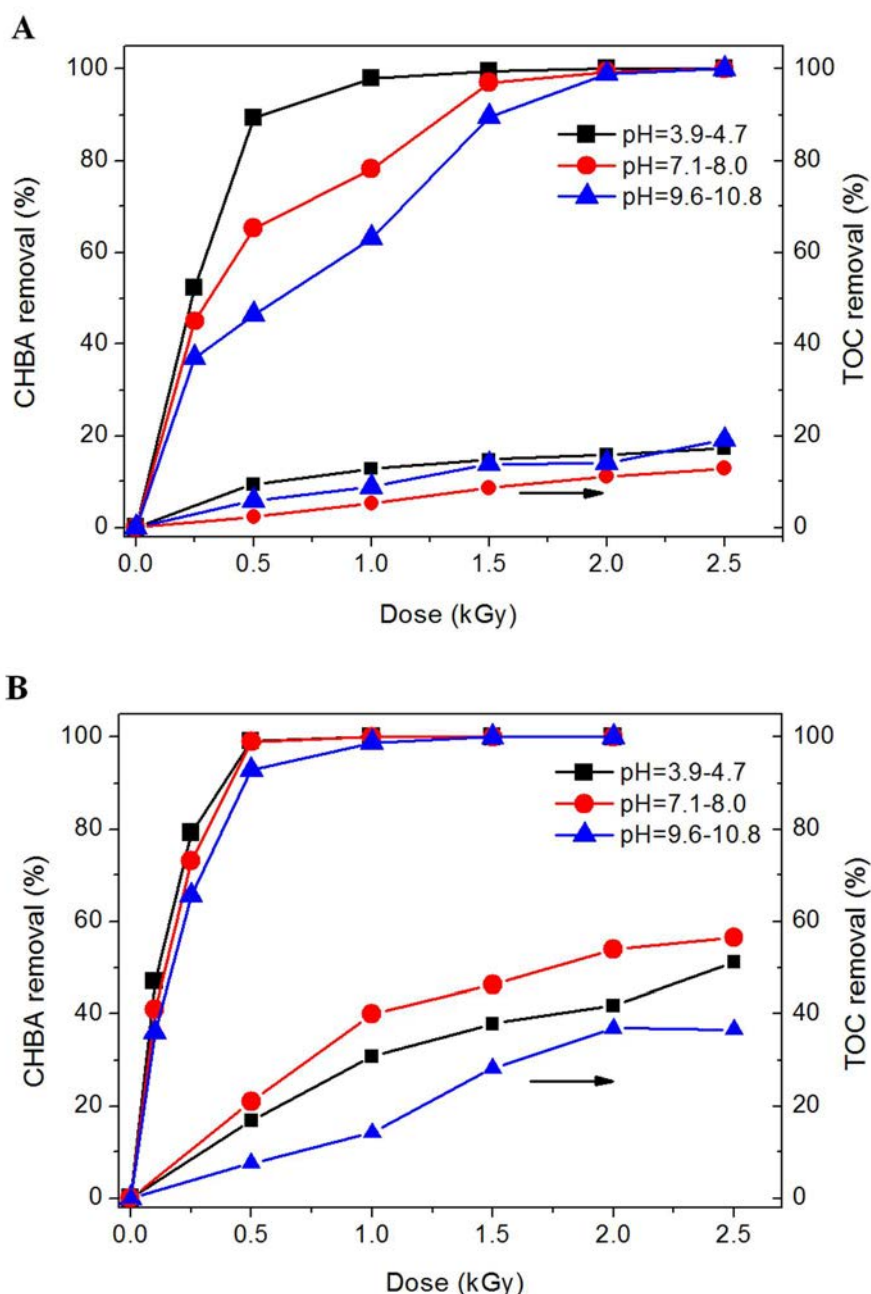
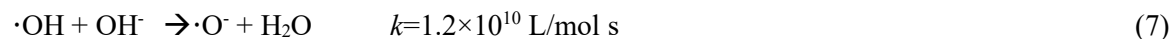
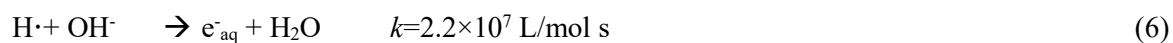
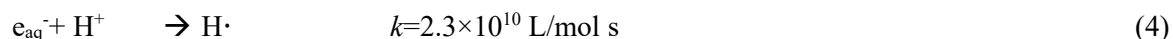
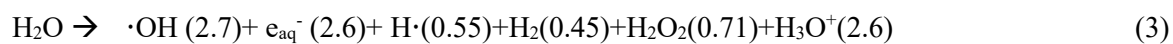

FIG. 2. Effect of initial pH and water matrix (A treated effluent, B pure water) on CHBA degradation by gamma irradiation (initial CHBA concentration: 8.0 mg/L).

Gamma irradiation of aqueous solution produces several reactive species (Eq. 3) mainly involving hydroxyl radicals, hydrated electrons and hydrogen atom, which play the primary role in degrading organic pollutants. The composition of the chemical species formed during water radiolysis is related to the solution pH. At acidic conditions, e_{aq}^- is likely to react with H^+ to produce H^\cdot (Eq. 4) and the recombining reaction between e_{aq}^- and $\cdot OH$ (Eq. 5) would be decreased. At alkaline pH, H^\cdot reacts readily with OH^- to generate e_{aq}^- (Eq. 6), increasing the possibility of recombination of e_{aq}^- and $\cdot OH$. Moreover, in alkaline solution the $\cdot OH$ radicals is readily converted to $\cdot O^-$ (Eq. 7) which is less reactive [24]. As a results, the effective concentration of $\cdot OH$ was reduced and the efficacy of CHBA degradation was decreased under alkaline conditions.



In comparison of the water matrix on CHBA removal following gamma irradiation, the rate constant for CHBA removal in the treated effluent is 1.7–3.5 times lower than that in pure water. But a complete removal of CHBA from treated effluent could still be achieved by increasing the absorbed doses. The treated effluent is characterized by complex composition, containing dissolved organic substances, inorganic anions and cations such as HCO_3^- , NO_3^- , Cl^- and NH_4^+ , and some metal ions. The lower degradation rate of CHBA in the treated effluent might be due to the competition for reactive species generated during gamma irradiation between CHBA and dissolved organic substances and the scavenging of the radicals from some inorganic anions such as HCO_3^- , CO_3^{2-} and NO_3^- . Sanchez-Polo et al. [21] attributed the low degradation rate of metronidazol in wastewater to the high concentration of dissolved organic compounds which competes with metronidazol for the radicals formed during gamma irradiation. The study by Kubesch et al. [18] demonstrated that the required dose for complete removal of catechol (55 mg/L) by gamma radiolysis was 3.0 kGy in distilled water and it increased to 9.0 kGy in tap water owing to the presence of HCO_3^- (4.43 mmol/L). Guo et al. [23] found that the removal of sulfadiazine decreased from 44% to 36% with 20 mg/L Na_2CO_3 addition at a dose of 350 Gy.

It is known that CO_3^{2-} and HCO_3^- is usually used to scavenge the production of $\cdot\text{OH}$ (Eqs. 8–9). CO_3^{2-} also could react with e_{aq}^- as shown in Eq. 10. NO_3^- was reported to react readily with e_{aq}^- [20]. Zheng et al. [19] found that addition of CO_3^{2-} or NO_3^- during gamma irradiation decreased the degradation efficiency of ibuprofen in aqueous solution.

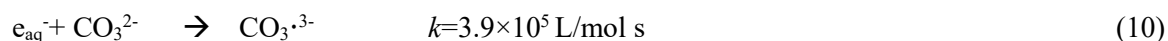

In terms of the mineralization, the efficiency of TOC removal increased slowly and reached a plateau with increasing the absorbed doses. The TOC removal was not as effective as CHBA removal. At an absorbed dose of 2.5 kGy, TOC removal efficiency was 37–57% in the CHBA-contaminated pure water and 13–19% in treated effluent. The results indicated that gamma irradiation could lead to complete decomposition of CHBA and a partial mineralization.

The degradation of CHBA in aqueous solution using gamma irradiation was affected by the produced reactive species from water radiolysis. Fig. 3 depicts the changes in G values of CHBA at different absorbed doses in the treated effluent and pure water. It is obviously that the G values decreased with the increase in the absorbed dose and it was lower in the treated effluent. The similar trend of radiation chemical yield was reported by other researchers [25, 21, 19]. The decreased G values of CHBA following gamma irradiation might be due to the competitive reaction for reactive species between CHBA and the intermediates generated following gamma irradiation (and dissolved organic substances for treated effluent). In

addition, the radicals could also react with each other (Eqs. 5, 11–13) and its concentration for reaction with CHBA would be reduced.

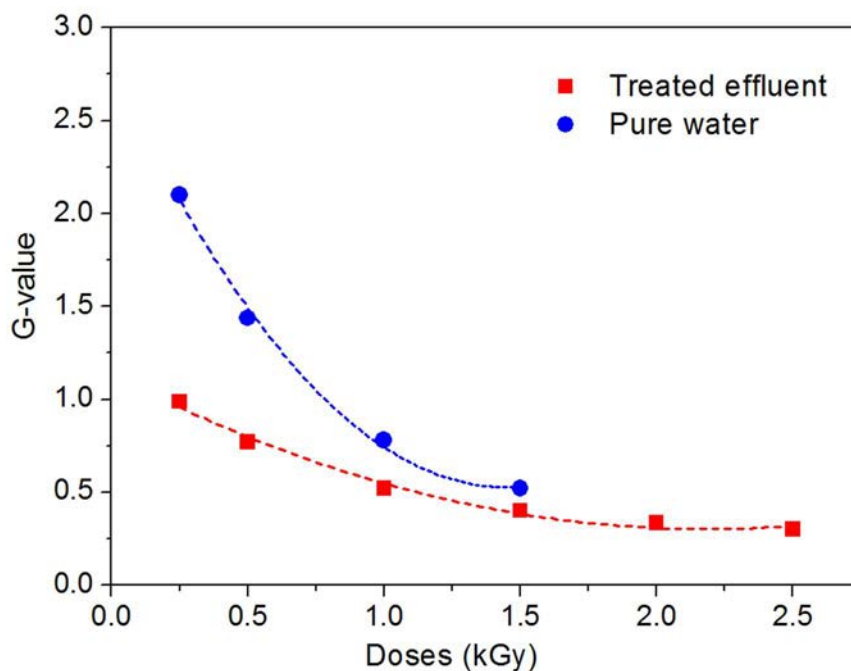
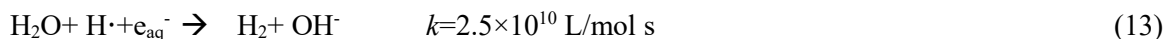
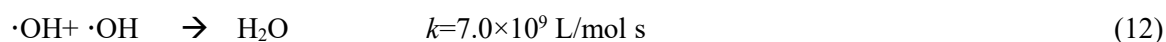
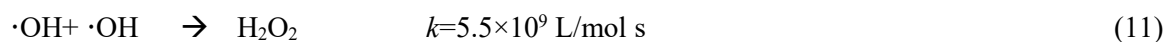

FIG. 3. G-value during gamma irradiation-induced degradation of CHBA in treated effluent and pure water (initial CHBA concentration: 15 mg/L, pH=6.7)

4.1.2. Effect of initial CHBA concentration

The radiolytic decomposition of CHBA at different initial concentrations in the treated effluent and pure water was shown in Fig. 4. The removal percentage of CHBA decreased with increasing the initial concentrations. At initial concentrations of 8, 15 and 30 mg/L, the required doses for 98% of CHBA removal were around 0.5, 1.0 and 2.0 kGy, respectively in pure water and more than twice in treated effluent. It is interesting to note that the TOC removal efficiency in pure water decreased markedly from 51% to 15% when the CHBA initial concentrations increased from 8 mg/L to 30 mg/L at a dose of 2.5 kGy, while it almost maintained at the same levels of 15–17% in the treated effluent, which could be attributed to the competence reaction of the reactive species with the organic compounds existed in the treated effluent. The formed radicals by water radiolysis might be used to react with the dissolved organic substances but not to degrade CHBA and the intermediates during gamma irradiation of CHBA contaminated treated effluent.

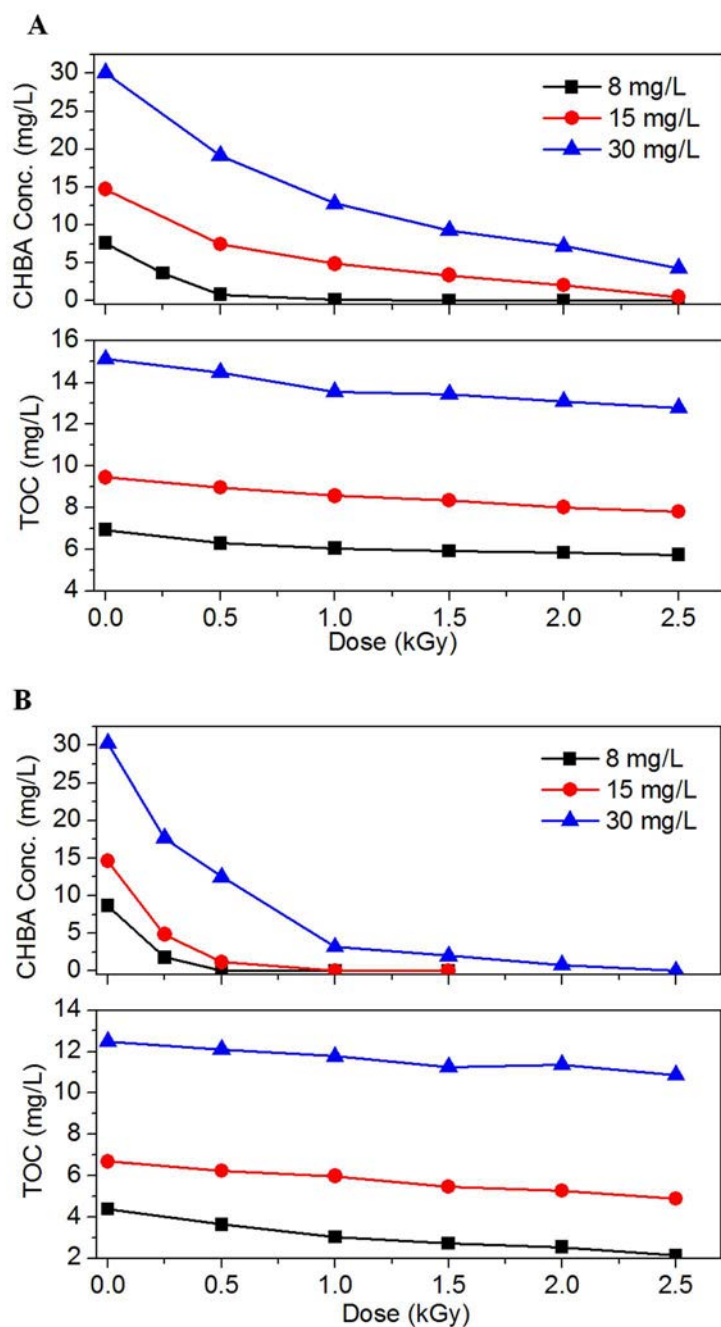

FIG. 4. Gamma irradiation-induced degradation of CHBA at different initial concentrations in treated effluent (A) and pure water (B) (pH= 6.7).

4.2. Comparison of the enhancement of CHBA degradation in the treated effluent by catalytic gamma irradiation

To enhance the efficiency of CHBA degradation in the treated effluent, the catalytic gamma irradiation by adding Fe^{2+} , H_2O_2 , CeO_2 and carbon nanotubes, respectively was studied. Results (Fig. 5) demonstrated that at an absorbed dose of 2 kGy, the CHBA removal efficiency increased from 85% using gamma irradiation alone to 97%, 96%, 89% and 94%, respectively by addition of Fe^{2+} , H_2O_2 , CeO_2 and carbon nanotubes during irradiation, while the TOC removal efficiency increased by 10%, 4%, 5% and 26%, respectively. The higher enhancement of carbon nanotubes was attributed to adsorption. Approximate 33% of CHBA

and TOC removal was achieved by using carbon nanotubes alone. Addition of CeO_2 resulted in only a small improvement in the degradation of CHBA. Addition of Fe^{2+} and H_2O_2 facilitated the degradation of CHBA in the treated effluent following gamma irradiation. The efficiency of CHBA removal and TOC removal increased by 11–12% and 4–10% in the presence of Fe^{2+} and H_2O_2 additives, respectively. It has been reported [26] that H_2O_2 could accelerate the production of hydroxyl radicals through Eqs. 14–15. Fe^{2+} could react with H_2O_2 generated during gamma irradiation to produce more active $\cdot\text{OH}$ according to Fenton reaction (Eq. 16). As a result, the degradation of CHBA was promoted.

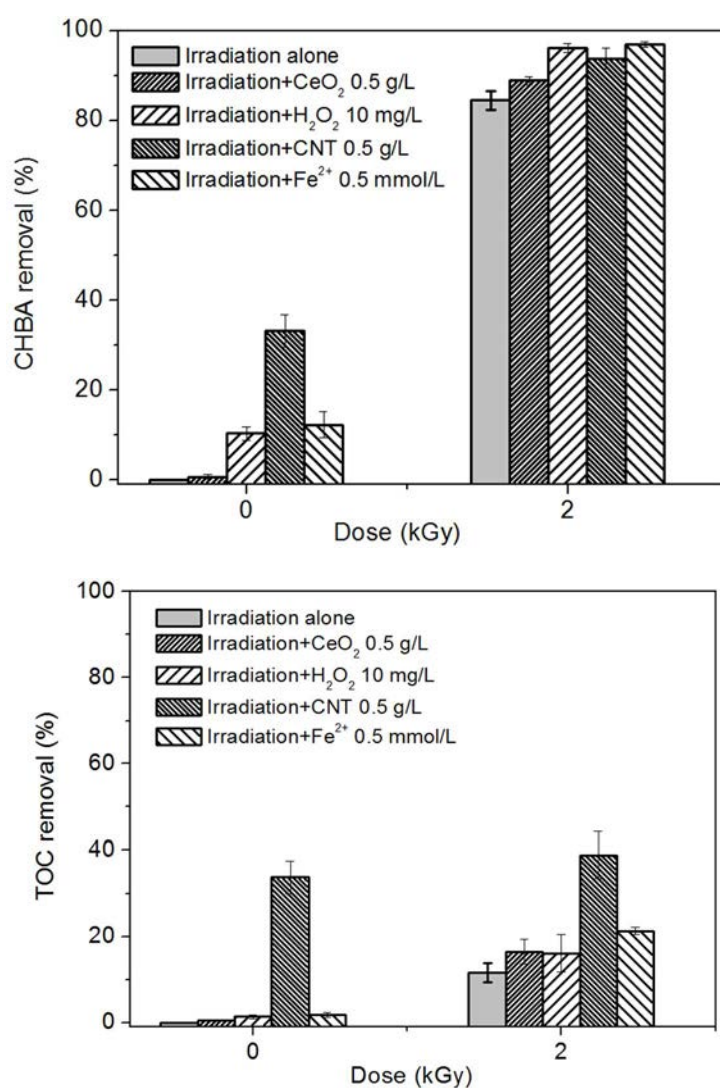
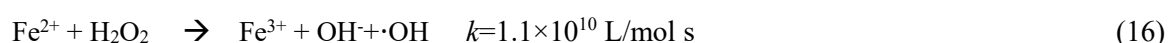
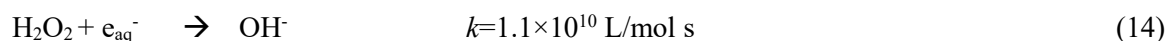

FIG. 5. Enhancement of gamma irradiation-induced degradation of CHBA in treated effluent (initial CHBA concentration: 15 mg/L, pH=6.7).

4.3. Proposed CHBA degradation mechanism by gamma irradiation

Fig. 6 depicts the evolution of UV-Vis spectra of CHBA at 200–400 nm following gamma irradiation in the two-water matrix. The typical aromatic absorption peak of CHBA (at 248 nm in pure water and 267 nm in treated effluent) decreased as a function of absorbed dose and disappeared almost completely at 1.0 kGy in pure water and 2.0 kGy in treated effluent. This indicated that the CHBA was destroyed and the cleavage of the aromatic ring took place almost completely.

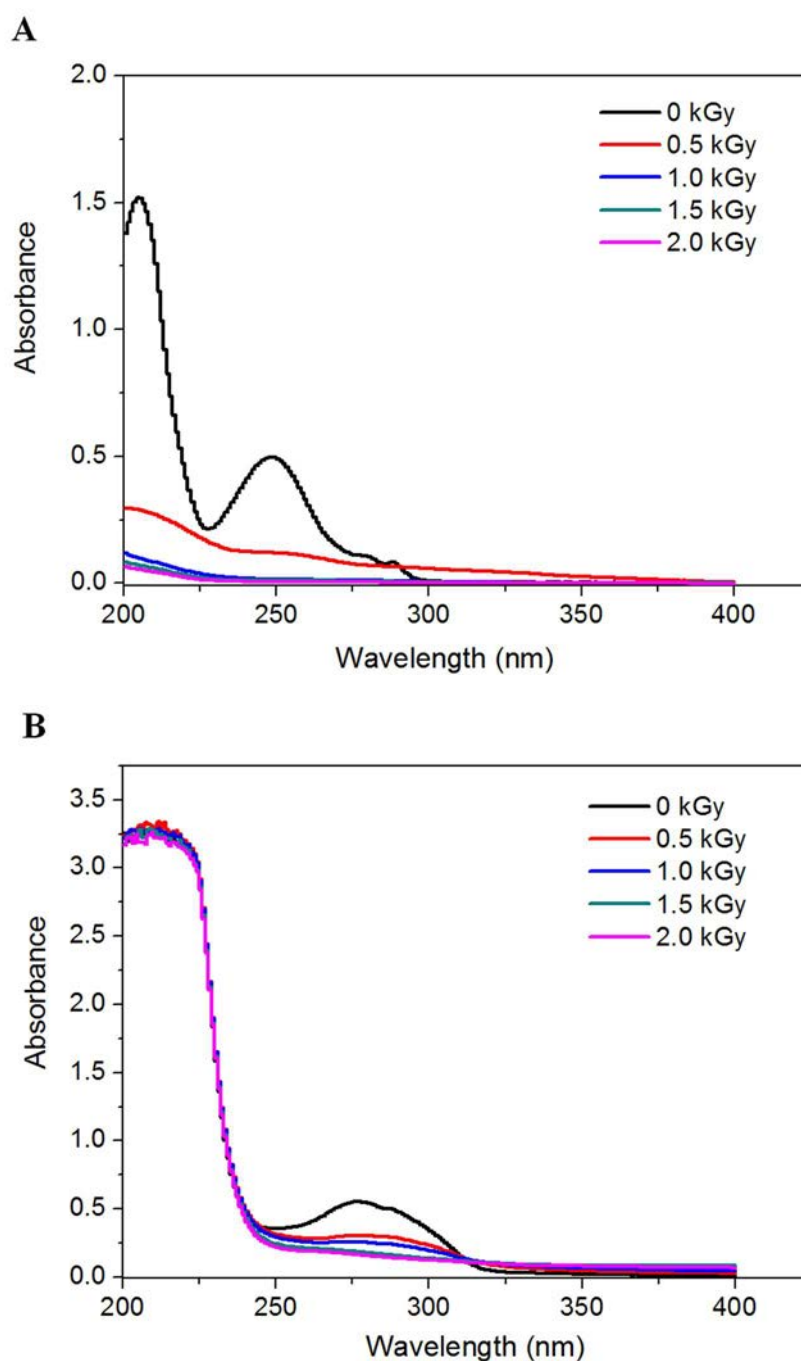

FIG. 6. UV-Vis spectrum of CHBA at 220–400 nm in pure water (A) and treated effluent (B) following gamma irradiation (initial CHBA concentration: 8.0 mg/L).

It is noteworthy that as exposed to gamma irradiation, the oxidation species $\cdot\text{OH}$ coexisted with the reduction species e_{aq}^- and $\cdot\text{H}$ approximately at the same amounts. This is different from the commonly used AOP such as ozonation and Fenton oxidation. CHBA would react with not only $\cdot\text{OH}$ radicals but also e_{aq}^- and $\cdot\text{H}$. The hydrated electron acts as a nucleophile in the reaction with organic substances and the reactivity was increased when the organic molecules contain substituent halogen atoms in which the halide ion was released rapidly (Eq. 17) [27]. This is beneficial for the degradation of chlorinated aromatic compounds like CHBA.



The release of Cl^- was monitored following gamma irradiation (Fig. 7). The Cl^- concentration in the solution increased rapidly with increasing the absorbed dose and more than 97% of total stoichiometric chlorine was released into the solution at an absorbed dose of 1.0 kGy, indicating the complete cleavage of the C-Cl bond. Solpan and Torun [12] studied the gamma irradiation-induced degradation of 2,4-dichlorophenoxyacetic acid (50 mg/L) in deionized water. More than 95% of all the chlorine atoms were found as free Cl^- at an absorbed dose of 5.0 kGy, which was ascribed to the attack of e_{aq}^- .

As shown in Fig. 6, formic acid and acetic acid, which represent the last step before mineralization, were detected after gamma irradiation of CHBA and their concentrations increased with the increase in the absorbed doses. This indicated that the aromatic ring of CHBA was broken by attack of $\cdot\text{OH}$ radicals and the intermediate products were further decomposed to carboxylic acids after gamma irradiation. In order to identify the intermediates of CHBA degradation by gamma irradiation, samples at the absorbed dose of 0.5 kGy was analysed by GC-MS. Benzenemethanol, hexanol, acetaldehyde were detected. Benzenemethanol might be from the reduction of benzoic acid and hexanol and acetaldehyde were the radiolytic fragmentation products of the aromatic ring opening due to the oxidation by $\cdot\text{OH}$ radicals. It is known that $\cdot\text{OH}$ radical is a powerful oxidant. $\cdot\text{OH}$ behaves as an electrophile when it reacts with the organic substances [27]. Thus, it readily adds to the unsaturated bonds of benzene ring, further leading to ring opening. As a result, carboxylic acids, acetaldehyde, and other intermediates were produced in the solution.

These results suggested that the degradation of CHBA using gamma irradiation took place mainly via two pathways: oxidation by $\cdot\text{OH}$ and reduction by e_{aq}^- and $\text{H}\cdot$. As exposed to gamma irradiation, dechlorination takes place rapidly and combines with the oxidation and cleavage of the aromatic ring. As a result, chlorine was completely released to the solution as Cl^- and small carboxylic acids and acetaldehyde were generated.

REFERENCES

- [1] PARK, W., HWANG, M.H., KIM, T.H., LEE, M.J., KIM, I.S., Enhancement in characteristics of sewage sludge and anaerobic treatability by electron beam pre-treatment. *Radiat. Phys. Chem.* **78**(2), (2009) 124–129.
- [2] CHITOSE, N., UETA, S., SEINO, S., YAMAMOTO, T.A., Radiolysis of aqueous phenol solutions with nanoparticles. 1. Phenol degradation and TOC removal in solutions containing TiO_2 induced by UV, gamma-ray and electron beams. *Chemosphere* **50**(8), (2003) 1007–1013.
- [3] CRIQUET, J., KARPEL VEL LEITNER, N. Reaction pathway of the degradation of the p-hydroxybenzoic acid by sulphate radical generated by ionizing radiations. *Radiat. Phys. Chem.* **106**, (2015) 307–314.

- [4] DRZEWICZ, P., TROJANOWICZ, M., ZONA, R., SOLAR, S., GEHRINGER, P., Decomposition of 2,4-dichlorophenoxyacetic acid by ozonation, ionizing radiation as well as ozonation combined with ionizing radiation. *Radiat. Phys. Chem.* **69(4)**, (2004) 281–287.
- [5] HU, J., WANG, J.L., Degradation of chlorophenols in aqueous solution by gamma-radiation. *Radiat. Phys. Chem.* **76(8–9)**, (2007) 1489–1492.
- [6] ZONA, R., SOLAR, S., GEHRINGER, P., Degradation of 2,4-dichlorophenoxyacetic acid by ionizing radiation: influence of oxygen concentration. *Water Res.* **36(5)**, (2002) 1369–1374.
- [7] CSAY, T., RACZ, G., TAKACS, E., WOJNAROVITS, L., Radiation induced degradation of pharmaceutical residues in water: Chloramphenicol. *Radiat. Phys. Chem.* **81(9)**, (2012) 1489–1494.
- [8] HOMLOK, R., TAKACS, E., WOJNAROVITS, L., Ionizing radiation induced reactions of 2,6-dichloroaniline in dilute aqueous solution. *Radiat. Phys. Chem.* **81(9)**, (2012) 1499–1502.
- [9] KIMURA, A., OSAWA, M., TAGUCHI, M., Decomposition of persistent pharmaceuticals in wastewater by ionizing radiation. *Radiat. Phys. Chem.* **81(9)**, (2012) 1508–1512.
- [10] SZABO, L., TOTH, T., HOMLOK, R., TAKACS, E., WOJNAROVITS, L. Radiolysis of paracetamol in dilute aqueous solution. *Radiat. Phys. Chem.* **81(9)**, (2012) 1503–1507.
- [11] CHU, L.B., WANG, J.L., WANG, B., Effect of gamma irradiation on activities and physicochemical characteristics of sewage sludge. *Biochem. Eng. J.* **54(1)**, (2011) 34–39.
- [12] SOLPAN, D., TORUN, M., (2012). The removal of chlorinated organic herbicide in water by gamma-irradiation. *J. Radioanalyt. Nuclear Chem.* **293(1)**, (2002) 21–38.
- [13] WANG, J.L., WANG, J.Z., Application of radiation technology to sewage sludge processing: A review. *J. Hazard Mat.* **143(1–2)**, (2007) 2–7.
- [14] HE, S., WANG, J., YE, L., ZHANG, Y., YU, J., Removal of diclofenac from surface water by electron beam irradiation combined with a biological aerated filter. *Radiat. Phys. Chem.* **105**, (2014) 104–108.
- [15] ZONA, R., SOLAR, S., Oxidation of 2,4-dichlorophenoxyacetic acid by ionizing radiation: degradation, detoxification and mineralization. *Radiat. Phys. Chem.* **66(2)**, (2003) 137–143.
- [16] OCAMPO-PEREZ, R., RIVERA-UTRILLA, J., SANCHEZ-POLO, M., LOPEZ-PENALVER, J.J., LEYVA-RAMOS, R., Degradation of antineoplastic cytarabine in aqueous solution by gamma radiation. *Chem. Eng. J.* **174(1)**, (2011) 1–8.
- [17] ABDEL DAIEM, M.M., RIVERA-UTRILLA, J., OCAMPO-PEREZ, R., SANCHEZ-POLO, M., LOPEZ-PENALVER, J.J., Treatment of water contaminated with diphenolic acid by gamma radiation in the presence of different compounds. *Chem. Eng. J.* **219** (2013) 371–379.
- [18] KUBESCH, K., ZONA, R., SOLAR, S., GEHRINGER, P., Degradation of catechol by ionizing radiation, ozone and the combined process ozone-electron-beam. *Radiat. Phys. Chem.* **72(4)**, (2005) 447–453.
- [19] ZHENG, B.G., ZHENG, Z., ZHANG, J.B., LUO, X.Z., WANG, J.Q., LIU, Q., WANG, L.H., Degradation of the emerging contaminant ibuprofen in aqueous solution by gamma irradiation. *Desalination* **276(1–3)**, (2011) 379–385.
- [20] HOMLOK, R., TAKACS, E., WOJNAROVITS, L., Elimination of diclofenac from water using irradiation technology. *Chemosphere* **85(4)**, (2011) 603–608.

- [21] SANCHEZ-POLO, M., LOPEZ-PENALVER, J., PRADOS-JOYA, G., FERRO-GARCIA, M.A., RIVERA-UTRILLA, J., Gamma irradiation of pharmaceutical compounds, nitroimidazoles, as a new alternative for water treatment. *Water Res.* **43(16)**, (2009) 4028–4036.
- [22] XU, L.J., WANG, J.L., Magnetic nanoscaled Fe₃O₄/CeO₂ composite as an efficient fenton-like heterogeneous catalyst for degradation of 4-chlorophenol. *Environ. Sci. Technol.* **46(18)**, (2012) 10145–10153.
- [23] GUO, Z., ZHOU, F., ZHAO, Y., ZHANG, C., LIU, F., BAO, C., LIN, M., Gamma irradiation-induced sulfadiazine degradation and its removal mechanisms. *Chem. Eng. J.* **191**, (2012) 256–262.
- [24] POSKREBYSHEV, G.A., NETA, P., HUIE, R.E., Temperature dependence of the acid dissociation constant of the hydroxyl radical. *J. Phys. Chem. Ref. Data* **106(47)**, (2002) 11488–11491.
- [25] KONGMANY, S., FURUTA, M., MATSUURA, H., OKUDA, S., IMAMURA, K., MAEDA, Y., Degradation of phorbol 12,13-diacetate in aqueous solution by gamma irradiation. *Radiat. Phys. Chem.* **105**, (2014) 98–103.
- [26] WANG, J.L., XU, L.J., Advanced oxidation processes for wastewater treatment: formation of hydroxyl radical and application. *Crit. Rev. Environ. Sci. Technol.* **42(3)**, (2012) 251–325.
- [27] BUXTON, G.V., GREENSTOCK, C.L., HELMAN, W.P., ROSS, A.B., Critical review of rate constants for reactions of hydrated electrons, hydrogen atoms and hydroxyl radicals ($\bullet\text{OH}/\bullet\text{O}^-$) in aqueous solution. *J. Phys. Chem. Ref. Data* **17(2)**, (1988) 513–886.
- [28] SINGH, A., KREMERS, W., Radiolytic dechlorination of polychlorinated biphenyls using alkaline 2-propanol solutions. *Radiat. Phys. Chem.* **65(4–5)**, 467–472.

ADVANCED TREATMENT OF INDUSTRIAL TEXTILE WASTEWATER BY ELECTRON BEAM BASED TECHNOLOGIES: LAB- AND PILOT-SCALE EXPERIMENTS

C. CHEN¹, Y. ZHANG¹, L. ZHANG¹, W. LUO¹, J. YU¹, S. HE², J. WANG²
CGNPC dasheng accelerator technology co., LTD. Suzhou,
Jiangsu 215214

² Institute of Nuclear and New Energy Technology (INET)
Collaborative Innovation Center for Advanced Nuclear Energy Technology, INET
Tsinghua University, Beijing 100084
China

Abstract

Effects of coagulation/flocculation, coagulation/flocculation + EB, Fenton, EB + Fenton on COD and colour indices removals were investigated for the advanced treatment of industrial textile wastewater. The results demonstrated that COD and colour indices were removed by coagulation/flocculation, EB irradiation as well as Fenton reaction. However, the combination of EB and Fenton can significantly decrease COD and colour indices to below 50 mg/L and 10 times, respectively. A following pilot-scale demonstration study on EB irradiation of industrial textile wastewater also confirmed the lab-scale experiments.

1. OBJECTIVE OF THE RESEARCH

Advanced treatment of industrial textile wastewater in lab-scale and pilot-scale were constructed with a Rhodotron TT200 accelerator and a DG accelerator in CGNPC dasheng accelerator technology co., LTD in Suzhou, China. Effects of coagulation/flocculation, coagulation/flocculation + EB, Fenton, EB + Fenton on COD and colour indices removals were investigated.

2. INTRODUCTION

The industrial wastewater is one of the largest pollution sources in China. The total industrial wastewater discharge was estimated at 20.98 billion tons in 2013. Discharges of some important industries were summarized in Fig. 1. Industrial textile wastewater jumped into receiving water may cause awful impacts on aqueous ecosystems and human health [1, 2]. The increasing extent of pollution and complexity of effluents from industries required effective and efficient technologies to reduce pollutants to the water quality criteria.

For this reason, chemical coagulation/flocculation [3], activated carbon adsorption [4], and membrane filtration [5] are proposed as possible alternatives to improve the quality of textile and dyeing wastewater. However, these methods proved to be less efficient to decompose the stable dyes, in many cases pollutants only transfer from one phase to another phase. On the other side, advanced oxidation processes (AOPs), including ozonation [6-8]; Fenton and Fenton-like reaction [9-11], photocatalysis [12-14], sonolysis [15] and plasma [16] have been studied for the tertiary treatment of textile and dyeing wastewater. The ionizing radiation process (including gamma ray and electron beam irradiation) also belongs to the AOPs family [17, 18], which has been widely used for the degradation of chlorophenols [19-21], nitrophenols [22], and pharmaceutical and personal care products (PPCPs) [23-25]. A number of researches have been conducted at bench-scale and pilot-scale textile and dyeing wastewater treatment [26-30]. Among the possible industrial wastewater treatment

technologies, radiation process is a remarkable option due to it can simultaneously degrade both the toxic organic compounds and the biological contaminants that are present [26].

However, the current researches barely discussing about combination of electron accelerator irradiation (EB irradiation) with other conventional technologies [31-34]. For high concentration organic pollutants, EB irradiation in combination with other advance technologies can significant remove pollutants without secondary pollution. In general, EB irradiation is easily adapted to the existing flow-through wastewater purification systems. A nozzle injector forms the continuous wastewater flow into a wide continuous water jet [35]. The aim of this study is to estimate the results of EB irradiation in combination with Fenton to treat the industrial textile wastewater for reuse and set up the first demonstration project in china.

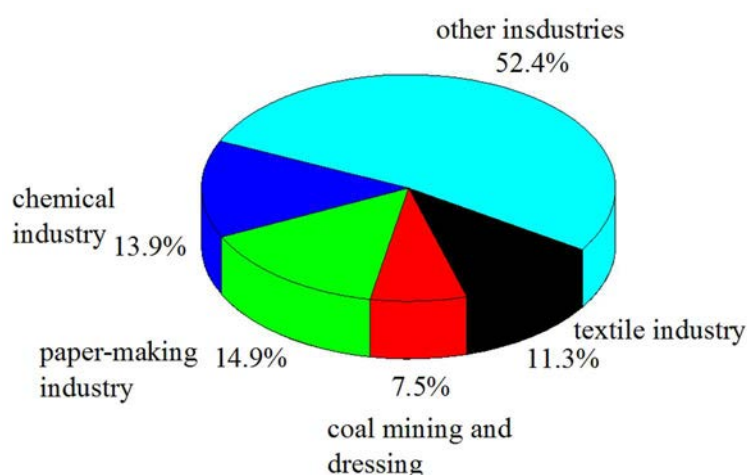

FIG. 1. Industrial wastewater discharge in 2013.

3. MATERIALS AND METHODS

3.1. Materials

Industrial textile wastewater after the biological and the second sedimentation was obtained from a knitting company located in Ningbo, Zhejiang province. Characteristics of the raw wastewater and wastewater reuse requirements were summarized in Table 1.

TABLE 1. CHARACTERISTICS OF INDUSTRIAL TEXTILE WASTEWATER SAMPLE

Sample	COD (mg/L)	Colour (times)	SS (mg/L)	Conductivity ($\mu\text{s}/\text{cm}$)	Hardness (mg/L)	pH
Raw	193	125	28	3876	122	7.40
Reuse requirements	≤ 50	≤ 25	≤ 20	≤ 1500	≤ 450	6~9

3.2. Experiments

Lab-scale experiments were conducted with a Rhodotron TT200 accelerator (energy 10 MeV, beam current 10 mA, beam power 100 kW). The accelerator was equipped with a track transport system to send the water samples to the irradiation room. The absorbed dose was

calibrated by a DEX B3 dosimeter. The pH value was adjusted using sulfuric acid and calcium hydroxide.

Pilot-scale trials were performed on a DG accelerator (energy 1.5 MeV, beam current 80 mA, beam power 120 KW) located in CGNPC dasheng accelerator technology co., LTD. The wastewater was pre-treated by Fenton before EB irradiation treatment. Aqueous streams of industrial wastewater were exposed to a scanned beam in a water film from a nozzle. The size of the nozzle is designed as 140 cm wide and 0.4 cm thick according to the penetration depth of 1.5 MeV electron beam in water. The average speed of the water film through the beam is approximately 2.8–3 m/s and a flow is about 56 to 60 m³/h. The absorbed dose was controlled at 1 kGy. All experiments were carried out at ambient temperature. The profile of pilot-scale electron beam (EB) radiation treatment of industrial wastewater and the under beam wastewater reactor are shown in Fig. 2 and Fig. 3, respectively.

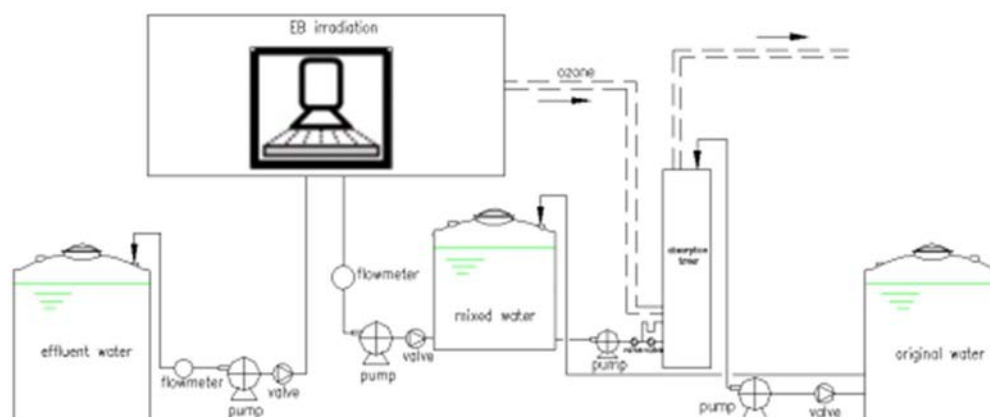

FIG. 2. Demonstration of EB irradiation treatment of industrial wastewater.



FIG. 3. Under beam wastewater reactor.

3.3. Analysis methods

Chemical oxygen demand (COD) concentration was determined according standard method (GB11892–89, 1990). The pH was obtained using a pH meter (PHS–3C, China). The colour

indices were determined by dilute times (The colour was compared with standard samples after dilution). Hardness was determined according determination of the sum of calcium and magnesium - EDTA titrimetric method (GB7477-87, 1987). A multi-parameter water quality device measured other data.

4. RESULTS AND DISCUSSION

4.1. Lab-scale experiments

4.1.1. Effect of coagulation/flocculation

A series of batch experiments were conducted to estimate the effects of coagulation/flocculation on the removal of COD and colour indices. PAM was controlled at 5‰. Initial concentration of COD and colour indices were 193 mg/L and 125 times, respectively. The results indicated that coagulation/flocculation improved the removal of COD and colour indices. COD removal efficiencies were stable at 62%. The lowest value of colour indices was obtained when the $\text{Al}_2(\text{SO}_4)_3$ dosage was 1.2‰. So, the dosage of $\text{Al}_2(\text{SO}_4)_3$ would be used in following experiments.

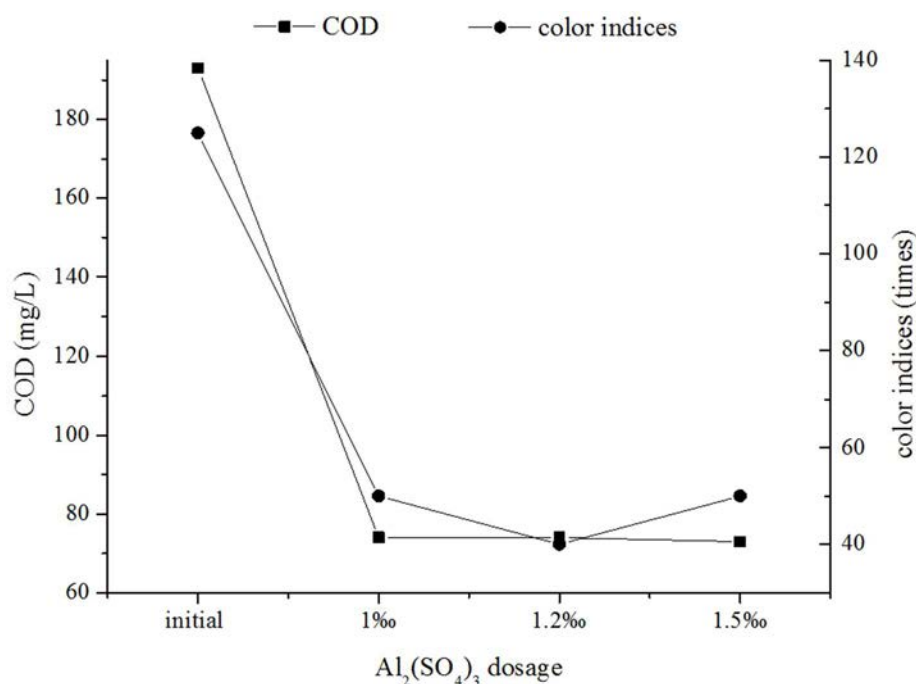

FIG. 4. Removal of COD and colour indices by coagulation/flocculation.

4.1.2. Effect of EB + coagulation/flocculation

In order to further reduce COD and colour indices, a combination of EB irradiation and coagulation/flocculation was utilized. For coagulation, $\text{Al}_2(\text{SO}_4)_3$ dosage was controlled at 1.2‰, and other parameters were the same with coagulation experiment. The absorbed dose was from 1 kGy to 3 kGy. As shown in Fig. 5, the COD concentration and colour indices decreased slowly with the increasing of absorbed dose. However, the colour value decreased to 40 times when the radiation dose was 3 kGy.

Compared Fig. 4 and Fig. 5, we could find that the combination of EB irradiation and coagulation/flocculation obtained a similar result with coagulation/flocculation alone, and it could not meet the requirements of customers yet.

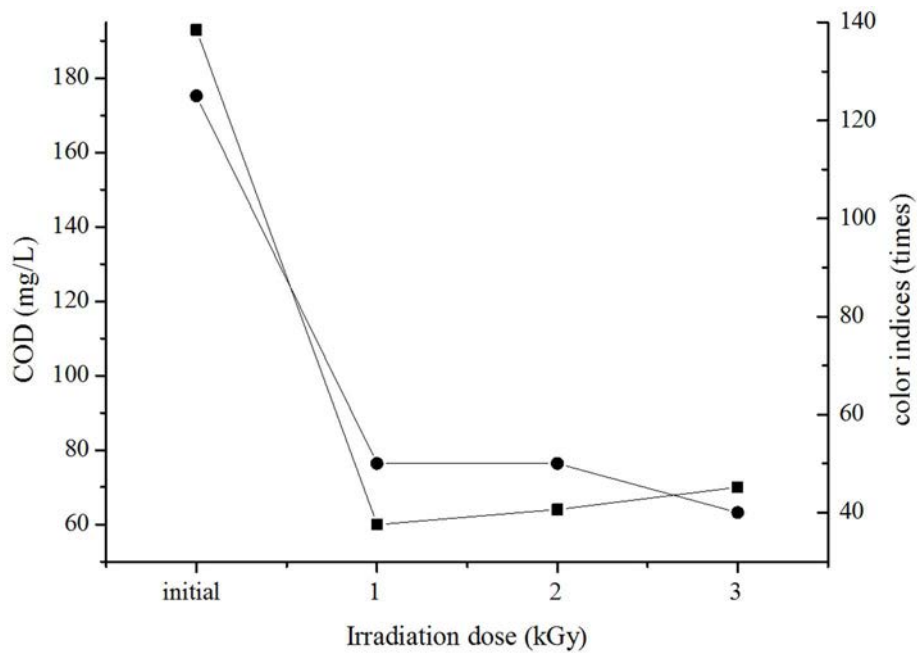

FIG. 5. Removal of COD and colour indices by EB +coagulation/flocculation.

4.1.3. Effects of Fenton reaction

Fenton reaction was used to estimate the effects of Fenton on the removal of COD and colour indices, and the coagulation condition was the same as mentioned above. The whole Fenton reaction process has gone through 3.5 hours. Fig. 6 depicted the variation of COD and colour indices removal efficiencies along with the variation of H_2O_2 and ferrous ion concentrations. The COD and colour indices removal efficiencies increased with increasing H_2O_2 and ferrous ion concentration and reached the optimized 82% and 80% when H_2O_2 and ferrous ion concentration were 999 mg/L and 60mg/L, respectively. It was interesting to note that, if compared with EB irradiation, the COD removal efficiency was higher when Fenton reaction was adopted mainly due to its high Fenton dose and the long reaction time.

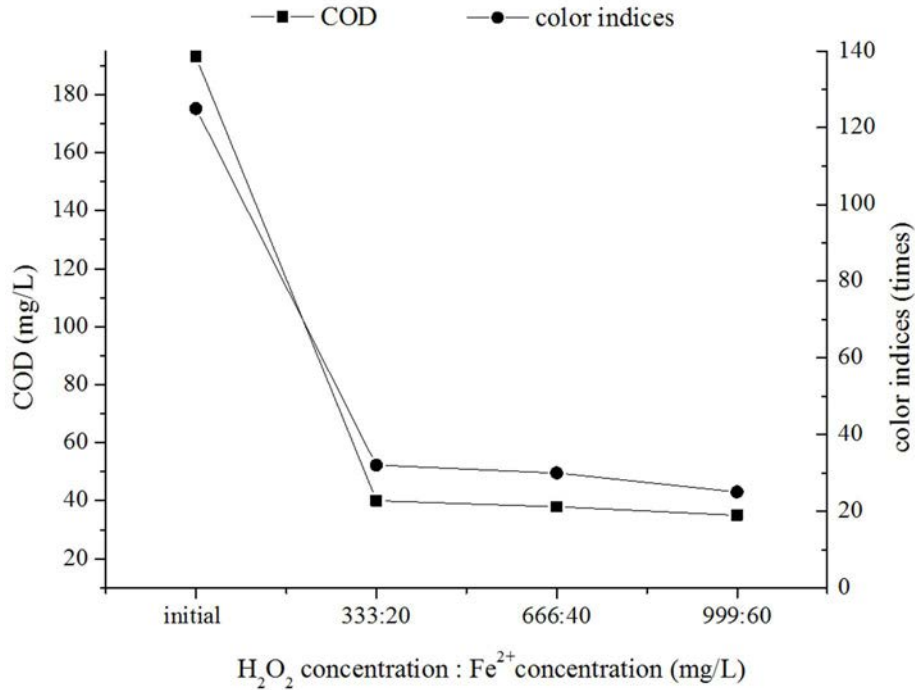

FIG. 6. Effects of Fenton reaction on removal of COD and colour indices.

4.1.4. Effects of Fenton +EB irradiation

Depending on the results of above experiments, all treatments could reduce COD and colour indices, but the effluent concentration could not meet the requirement of wastewater reuse requirements. In order to largely degrade pollutants, a combination of Fenton with EB irradiation was conducted, and the ferrous ion concentration and EB irradiation dose were 20 mg/L and 1 kGy, respectively. The performance of Fenton combined with EB irradiation was shown in Fig. 7. It could be observed that COD and colour indices drastically decreased after treatment of Fenton combined with EB irradiation. The effluent COD concentration and colour indices were stable at about 20 mg/L and 10 times, respectively. The qualities of effluent satisfied customer's requirements that COD concentration and colour indices should be below 50 mg/L and 20 times, respectively.

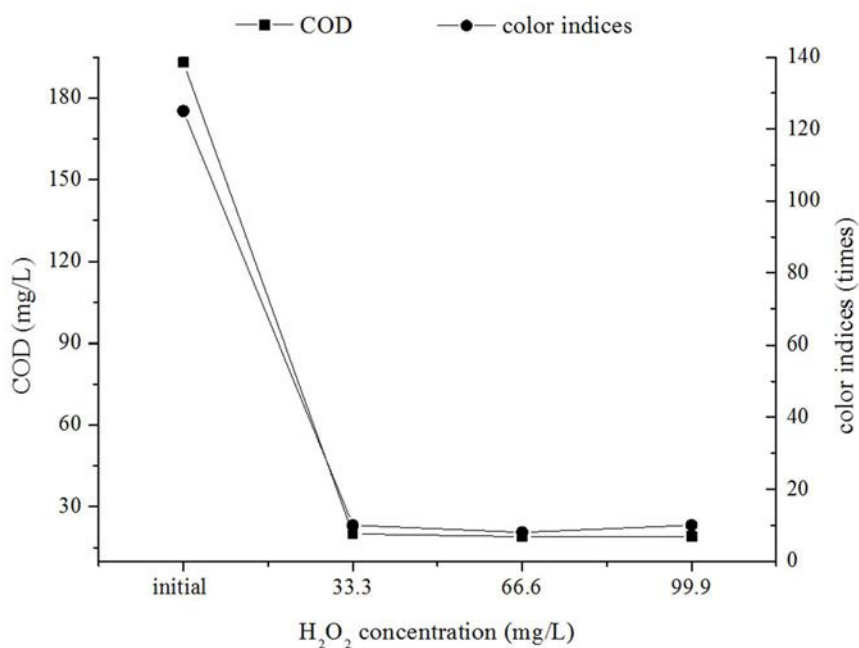

FIG. 7. Removal of COD and colour indices by Fenton + EB irradiation.

4.2. Pilot plant EB irradiation of industrial textile wastewater

4.2.1. Effects of EB + Fenton in pilot plant

The under beam reactor can produce a stable water flow and the water film thickness is uniformity. Electron beam accelerator can carry out stable irradiation dose during 24 hours continuously. The results of EB irradiation combined with Fenton treating industrial wastewater were summarized in Table 2. The condition of Fenton was controlled that H₂O₂ dosage was 66.6 mg/L and ferrous ion concentration was 20 mg/L. It could be observed that EB irradiation could significantly reduce COD and colour indices at 1 kGy. The initial COD concentration and colour indices were 280 mg/L and 100 times, respectively, and COD concentration and colour indices in the effluent respectively dropped to about 25 mg/L and 10 times. It was interesting to find that the COD and colour indices removal efficiencies were 91.1% and 90.0%, respectively. The COD concentration and colour indices in the effluent could satisfy the requirements of printing and dyeing wastewater reuse. However, EB irradiation had no effects on conductivity and hardness. No obvious change has been observed on them. So, in order to reduce the conductivity and hardness, membrane technology or other technologies should be united.

TABLE 2. THE EFFLUENT AFTER EB IRRADIATION TREATMENT

Sample	COD (mg/L)	colour indices (times)	SS (mg/L)	Conductivity (μs/cm)	Hardness (mg/L)	pH
Raw wastewater	280	100	28	3855	125	7.40
Treated Effluent	25	10	4	4193	122	7.55
Reuse standards	≤50	≤25	≤20	≤1500	≤450	6~9

4.3. Operating cost analysis

Operating cost is consisted of reagents and electric consumption, and it depends on large-scale test to calculate it. It can be found that the reagents cost was about ¥1598/d, and electric consumption was 2089 KW.h/d. In summary, the operating cost of EB irradiation treatment of industrial wastewater was ¥2.19/m³.

5. SUMMARY

The lab-scale and pilot-scale experiments demonstrated that COD and colour indices could be removed by coagulation/flocculation, EB irradiation or Fenton reaction. Coagulation/flocculation and EB irradiation attained similar results. COD concentration after the treatment was stable around 70 mg/L. However, all the above experimental results can't meet customer's requirements. In order to further decreased COD concentration and colour indices, a combination of EB irradiation with Fenton was conducted, which could effectively decrease COD and colour indices to below 50 mg/L and 10 times, respectively. The optimum H₂O₂ dosage and ferrous ion concentration were 66.6 mg/L and 20 mg/L, respectively.

As a consequence, a pilot-scale demonstration study on EB irradiation treatment of industrial wastewater has been conducted. The results were consistent with the previous laboratory experiments. The operating cost was ¥2.19/m³.

REFERENCES

- [1] BENOTTI, M.J., TRENHOLM, R.A., VANDERFORD, B.J., HOLADY, J.C., STANFORD, B.D., SNYDER, S.A., Pharmaceuticals and endocrine disrupting compounds in US drinking water. *Environ. Sci. Technol.*, **43**, (2009) 597–603.
- [2] MAKRIS, K.C., SNYDER, S.A., Screening of pharmaceuticals and endocrine disrupting compounds in water supplies of Cyprus. *Water Sci. Technol.* **62**, (2010) 2720–2728.
- [3] AKSHAYA KUMAR VERMA, RAJESH ROSHAN DASH, PUSPENDU BHUNIA., A review on chemical coagulation/flocculation technologies for removal of colour from textile wastewaters. *J. Environ. Manage.* **93**, (2012) 154–168.
- [4] YEH, R.Y.-L., HUNG, Y.-T., LIU, R.L.-H., CHIU, H.-M., THOMAS, A., Textile wastewater treatment with activated sludge and powdered activated carbon. *Int. J. Environ. Stud.* **59**, (2002) 607–622.
- [5] METIVIER-PIGNON, H., FAUR-BRASQUET, C., JAOUEN, P., LE CLOIREC, P., Coupling ultrafiltration with an activated carbon cloth for the treatment of highly coloured wastewaters: a techno-economic study. *Environ. Technol.* **24**, (2003) 735–743.
- [6] BERTANZA, G., PAPA, M., PEDRAZZANI, R., REPICE, C., MAZZOLENI, G., STEIMBERG, N., FERETTI, D., CERETTI, E., ZERBINI, I., EDCs, estrogenicity and genotoxicity reduction in a mixed (domestic + textile) secondary effluent by means of ozonation: A full-scale experience. *Sci. Total Environ.* **458**, (2013) 160–168.
- [7] LI, W., NANABOINA, V., ZHOU, Q.X., KORSHIN, G.V., Effects of Fenton treatment on the properties of effluent organic matter and their relationships with the degradation of pharmaceuticals and personal care products. *Water Res.* **46**, (2012) 403–412.
- [8] M.T.F. TABRIZI, D. GLASSER, D. HILDEBRANDT, Wastewater treatment of reactive dyestuffs by ozonation in a semi-batch reactor. *Chem. Eng. J.* **166** (2011) 662–668.
- [9] LUCAS, M.S., PERES, J.A., Decolorization of the azo dye Reactive Black 5 by Fenton and photo-Fenton oxidation. *Dyes Pigments* **71**, (2006) 236–244.
- [10] E. PAPADOPOULOS, D.FATTA, M.LOIZIDOU, Development and optimization of dark Fenton oxidation for the treatment of textile wastewaters with high organic load. *J. Hazard. Mater.* **146**, (2007) 558–563.

- [11] A.C.S.C. TEIXEIRA, ROBERTO GUARDANI, ANDRE M. BRAUN, ESTHER OLIVEROS, CLAUDIO A.O. NASCIMENTO, Degradation of an aminosilicone polymer in a water emulsion by the Fenton and the photochemically enhanced Fenton reactions. *Chem. Eng. Process.* **44**, (2005) 923–931.
- [12] E.R. BANDALA, MIGUEL A. PELAEZ, A. JAVIER GARCIA-LOPEZ, MARIA DE J. SALGADO, GABRIELA MOELLER., Photocatalytic decolourisation of synthetic and real textile wastewater containing benzidine-based azo dyes. *Chem. Eng. Process.* **47**, (2008) 169–176.
- [13] FERNANDO, J., BELTRAN, M.G., JUAN, F.G., Industrial wastewater advanced oxidation. Part 1. UV radiation in the presence and absence of hydrogen peroxide. *Water Res.* **31** (10), (1997) 2405–2414.
- [14] FERNANDO, J., BELTRAN, M.G., JUAN F.G., Industrial wastewater advanced oxidation. Part 2. Ozone combined with hydrogen peroxide or UV radiation. *Water Res.* **31** (10), (1997) 2415–2428.
- [15] ZEYNEP EREN., Ultrasound as a basic and auxiliary process for dye remediation: A review. *J. Environ. Manage.* **104**, (2012)127–141.
- [16] TICHONOVAS, M., KRUGLY, E., RACYS, V., HIPPLER, R., KAUNELIENE, V., STASIULAITIENE, I., MARTUZEVICIUS, D., Degradation of various textile dyes as wastewater pollutants under dielectric barrier discharge plasma treatment. *Chem. Eng. J.* **229**, (2013) 9–19.
- [17] WANG, J.L., WANG, J.Z., Application of radiation technology to sewage sludge processing: review. *J. Hazard Mater.* **143**, (2007) 2–7.
- [18] WANG, J.L., XU, L.J., Advanced oxidation processes for wastewater treatment: formation of Hhydroxyl radical and application. *Crit. Rev. Environ. Sci. Technol.* **42**, (2012) 251–325.
- [19] HU, J., WANG, J.L., CHENG, R., Degradation of chlorophenols in aqueous solution by γ -radiation and ozone oxidation. *Sci. China, B.* **49**, (2006) 186–192.
- [20] HU, J., WANG, J.L., Degradation of chlorophenols in aqueous solution by gamma-radiation. *Radiat. Phys. Chem.* **76**, (2007) 1489–1492.
- [21] XUE, J., WANG, J.L., Radiolysis of pentachlorophenol (PCP) in aqueous solution by gamma irradiation. *J. Environ. Sci.* **20**, (2008) 1153–1157.
- [22] YU, S.Q., HU, J., WANG, J.L., Gamma irradiation-induced degradation of p-nitrophenol (PNP) in the presence of hydrogen peroxide (H_2O_2) in aqueous solution. *Radiat. Phys. Chem.* **177**, (2010) 1061–1067.
- [23] LIU, Y.K., WANG, J.L. Degradation of sulfamethazine by gamma irradiation in the presence of hydrogen peroxide, *J. Hazard. Mater.* **250**, (2013) 99–105.
- [24] HE, S.J., WANG, J.L., YE, L.F., ZHANG, Y.X., YU, J., Removal of diclofenac from surface water by electron beam irradiation combined with a biological aerated filter. *Radiat. Phys. Chem.* **105**, (2014) 104–108.
- [25] LIU, Y.K., HU, J., WANG, J.L. Fe^{2+} enhancing sulfamethazine degradation in aqueous solution by gamma irradiation, *Radiat. Phys. Chem.* **96**, (2014) 81–87.
- [26] HAN, B.S., KIM, J.K., YURI KIM, ET AL., Operation of industrial-scale electron beam wastewater treatment plant. *Radiat. Phys. Chem.* **81**, (2012) 1475–1478.
- [27] DUARTE, C.L., SAMPA, M.H.O., RELA, P.R., SILVEIRA, C.G., “Application of electron beam irradiation combined with conventional treatment to treat industrial effluents”. *Radiat. Phys. Chem.*, 57 (2000) 513-518.
- [28] DILEK, S., OLGUN, G., Decoloration and degradation of some textile dyes by gamma irradiation. *Radiat. Phys. Chem.* **65**(4–5), (2002) 549–558.
- [29] DILEK, S., OLGUN, G., High-energy irradiation treatment of aqueous solutions of azo dyes: steady-state gamma radiolysis experiments. *Radiat. Phys. Chem.* **67**, (2003) 5831–534.
- [30] SUN, W.H., CHEN, L.J., TIAN, J.P., HE S.J., WANG, J.L., Ionizing radiation induced degradation of a monoazo dye - Alizarin Yellow GG in aqueous solution: Decoloration and biodegradability enhancement. *Radiat. Phys. Chem.* **83**, (2013) 86–89.

- [31] B.U. BAE, EUI-SUK, JUNG, YU-RI KIM, ET AL., Treatment of landfill leachate using activated sludge process and electron-beam radiation. *Water Res.* **33** (11), (1993) 2669–2673.
- [32] WANG T., WAITE TH. D., KURUCZ C., COOPER W.J., Oxidant reduction and biodegradability improvement of paper mill effluent by irradiation, *Water Res.* Vol. 28 (1994) 237-241.
- [33] ZHAO, J., WARD, O.P., et al. Process for degradation of nitrobenzene: combining electron beam irradiation with biotransformation. *Biotechnology and bioengineering*, 73(2001) 306–312.
- [34] SUN, W.H., TIAN, J.P., CHEN, L.J., HE S.J., WANG, J.L., Improvement of biodegradability of PVA-containing wastewater by ionizing radiation pretreatment. *Environ. Sci. Pollut. Res.* **19**, (2012) 3178–3184.
- [35] Radiation processing: environmental applications. Vienna: International Atomic Energy Agency, 2007, p.; 24cm., ISBN 92-0-100507-5.

RADIATION TREATMENT OF WASTEWATER FOR REUSE WITH PARTICULAR FOCUS ON WASTEWATERS CONTAINING ORGANIC POLLUTANTS AND REMOVAL OF HEAVY METALS FROM WASTEWATER

E-S.A. HEGAZY, H. ABDEL-REHIM, E.M. SHEHATA, G. ADEL, S. ELBAKRY, N. EL-DEGHIEDY

National Center for Radiation Research and Technology
Atomic Energy Authority, Cairo
Egypt

Abstract

During the period of this CRP, studies have been made on radiation processing for remediation of polluted waters and wastewater especially those resulted from textile industry. The effect of ionizing radiation on direct blue 3B dyes was carried at different dye concentrations (25–150 mg/l). Almost complete degradation was achieved for low dye concentration (25–50 mg/l) at 1–3 kGy irradiation doses. Different dose rates (0.715, 1.08 and 1.43 Gy/sec- total dose 3 kGy) were used to degrade the investigated dyes. It was found that as the dose rate increases the dye degradation rate decreases. The pH value of the solutions has a considerable effect on the dye degradation rate, for all investigated dyes, the lower the pH, the higher the dye degradation rate. Chemical Oxygen demand and Total Organic Carbon were also determined. It was found that significantly higher doses were required for appreciable changes in COD. The COD reduction was explained by oxygen addition reactions following reactions of the radiolytic species. The oxidation reactions can only proceed as long oxygen is available in the solution. The tendency of TOC, COD reduction & the change of pH values for all dye solutions were similar to each other. Also, it was found that the presence of oxygen or H₂O₂ enhances the degradation of such dyes even at low doses. The effect of PH on the G-value is very dependent on the irradiation atmosphere.

Studies were also done on the degradation behaviour of Rhodamine B dye when exposed to gamma irradiation. The effect of the presence and absence of oxygen on the decay of Rhodamine B solution was studied and showed that the presence of oxygen accelerates the decay of the dye. Proposed radiation degradation mechanisms of aerated and deaerated solution of Rhodamine B showed the formation of Rh B• which is the intermediate species in the bleaching process and the formation of O₂^{-•} /OOH• which is inhibited in case of deaerated Rhodamine B solution.

Polyvinyl alcohol/acrylic acid (PVA/AA) microgels were also prepared using electron beam irradiation. Immobilization of different titanium dioxide (TiO₂) concentrations on the surface of the prepared PVA-AA microgel was carried out. Photo-degradation efficiency of TiO₂/PVA-AA microgel against metanil yellow dyes was studied. TiO₂/PVA-AA microgel activity increases with the increase of the amount of TiO₂ and results in an increase in the rate of the photo-degradation reaction. Easily recovery and better reproducibility made TiO₂/PVA/AA of great important in practice use as a photo-catalytic degradation composite materials for safe treatment of textile wastewater.

Radiation enhancement of photocatalytic activity of conducting polyaniline–TiO₂ nanocomposites (PANI-TiO₂) for degradation of methyl orange dye under visible light was studied. TiO₂, PANI and PANI/TiO₂ nanocomposites were prepared. Photocatalytic degradation of methyl orange (MO) using low amount of PANI/TiO₂ nanocomposite as a

photocatalyst under visible light was investigated. The influence of TiO₂ content, concentration of An, An:APS ratio and different doses of gamma radiation on the photocatalytic activity of the prepared composites were studied.

Imprinted (Acrylamide /2-vinylpyrrolidone) (AAm/NVP) hydrogel was prepared by gamma-radiation for uptake Pb and Co ions from the aqueous environment. The imprinted hydrogel was evaluated for the binding capability towards Pb and Co ions in the aqueous environment and compared with non-imprinted one.

1. OBJECTIVE OF RESEARCH

The objective of this research is to degrade and remove some textile dyes into less harmful substances or reduce them to the level below the permissible concentrations using ionizing radiation and also photo catalyst degradation.

2. INTRODUCTION

The removal of organic pollutants such as dyes from textile wastewater is a major environmental problem because of the difficulty of treating such water by conventional methods. Coloured waters are also objectionable on aesthetic grounds for drinking and other municipal and agricultural purposes. Dyes released into the environment in industrial effluents are from two major sources, the textile and the dyestuff industries. A necessary criterion for the use of these dyes indicates that they are highly stable in light and during washing as well as to microbial attack [1, 2]. Most of these dyes are synthetic in nature and are classified based on their chemical structures into 6 different classes as azo, anthraquinone, sulphur, indigoid, triphenylmethane and phthalocyanine derivatives. There are four major technologies available to remove dyes from water, oxidation, adsorption, flocculation-precipitation, and membrane technology. Some groups have used various adsorbents for the removal of acidic and basic dyes from aqueous solutions. Ionizing radiation proved to be more effective for treatment of these wastewaters than ordinary conventional methods. Radiation-initiated degradation of organics helps to transform various pollutants into less harmful substances or reduced to the levels below the permissible concentrations. Some studies dealing with the use of gamma radiation in the treatment of wastewaters have shown that the most considerable effect, that is the degradation of the waste molecules (dyes) by the primary products formed during the radiolysis of water, is accompanied by the oxidation of a part of organic substances and is a function both of pH and oxygen concentration in the solution [3-10].

This study aimed to degrade and remove some textile dyes into less harmful substances or reduce them to the level below the permissible concentrations.

3. EXPERIMENTAL

3.1. Gamma Radiation Source:

The samples were irradiated with the Co-60 gamma rays at a dose rate ranging from 3.9 to 6.3 kGy/h.

Spectrophotometric Analysis: Ultraviolet Spectroscopy (UV): Analysis by UV spectrophotometer was carried out using Milton Roy spectronic 1201 in the range from 190 to 900A.

3.2. TiO₂ Immobilization

In a typical synthetic procedure, the gel pre-soaked in anhydrous methanol alcohol (Analar) for 48 h to ensure the gel complete dehydration. This is followed by the swelling of microgel in 5ml of different volumes of TiCl₄. The gel was then washed for several times by distilled water until the pH 7 is maintained, to ensure the complete conversion of TiCl₄, and then dried in oven overnight. Titanium tetrachloride is inorganic compound that undergo rapid hydrolysis in contact with water. This goes through a two stage process. First, it forms compounds known as the titanium oxychlorides and hydrogen chloride. It can be described as follows:

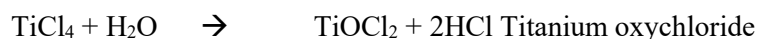

or



These oxychlorides are also particles, and they continue to react with water to form hydrogen chloride.



4. RESULTS AND DISCUSSION

Ionizing radiation proved to be more effective for the treatment of waste water than ordinary conventional methods. Some studies dealing with use of γ -irradiation in the treatment of waste water containing textile dyes have shown the most considerable effect. The decolourization, is accompanied by oxidation of part of the organic substances (Decrease in COD and TOC) and is a function both of pH and oxygen concentration of the solution.

4.1. Degradation of Basic Blue Dye using ionizing radiation

A series of experiments were carried out to study the effect of gamma irradiation on the aqueous solution of different Dyes. It is important to note that the study of the effect of gamma radiations on aqueous dye solution should cover a good range of irradiation doses. So, in the present work different concentrations of the dye stock solution were used for this study and represented graphically in Fig. 1. From the results obtained it was observed that beginning with low initial dye concentration (20mg/L), a dose of 4 kGy of γ -radiation was enough for almost the complete destruction of these dyes. While for the intermediate initial dye concentration (50mg/L), a dose of 10 kGy was needed to achieve this effect. A high initial dye concentration (100mg/L), a dose of 20 kGy of γ -radiation did not achieve the complete destruction of these dyes.

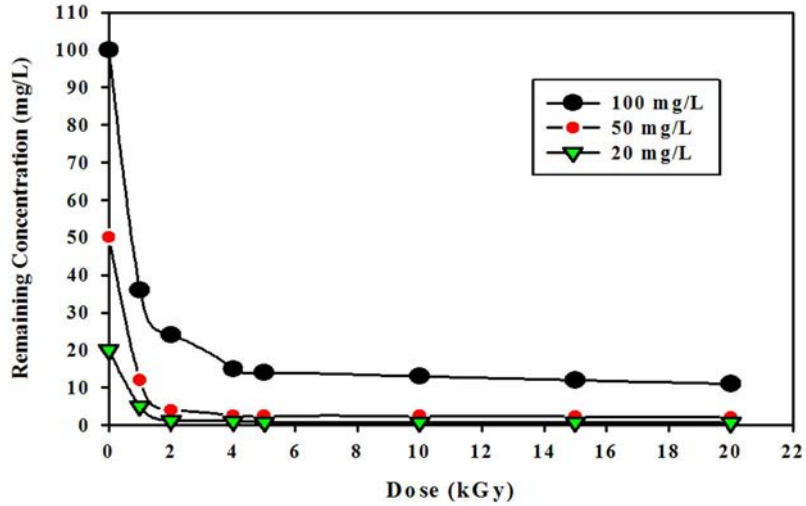

FIG. 1. Relationship between the remaining concentration of Basic Blue Dye and irradiation dose, initial dye concentration (mg/L).

The effect of pH value on degradation of dyes was investigated as shown in Fig. 2. It was found that a slight decrease in pH was observed for all the dye solutions. The drop in the pH of the dye solutions may be attributed to the mechanism of the radiation degradation process taking place in our studied system of the dye molecules to lower molecular weight compounds, such as organic acids. The dye molecules are degraded effectively by the primary active species formed from the radiolysis of water such as OH, HO₂ and the solvated electron e_{aq}⁻ or O₂⁻.

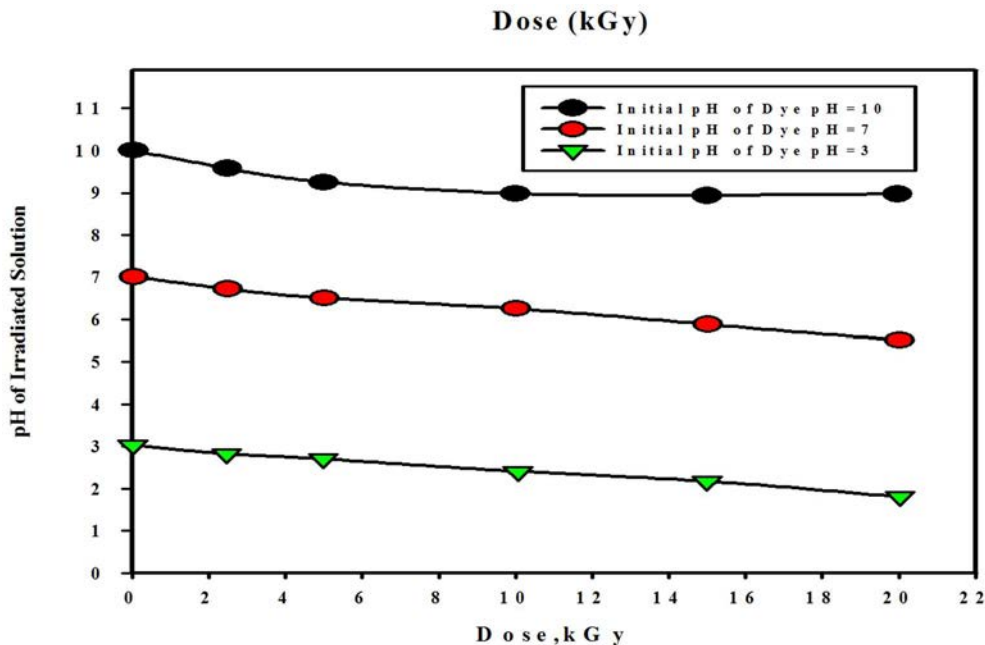

FIG. 2. Change in pH of irradiated Basic Blue Dye with dose.

4.1.1. Chemical Oxygen demand and Total Organic Carbon:

Table 1 shows the effect of irradiation dose on the COD and TOC for basic blue dyes under varying conditions of irradiation. The following changes were observed:

- Significantly higher doses were required for appreciable changes in COD.
- The COD reduction was explained by oxygen addition reactions following reactions of the radiolytic species.
- The oxidation reactions can only proceed as long oxygen is available in the solution.
- The tendency of TOC, COD reduction & the change of pH values for all dye solutions were similar to each other.

TABLE 1. CHANGE OF COD, TOC AND PH BY γ - IRRADIATION OF BASIC BLUE DYE

Dye	Dose (kGy)	Reduction %		PH
		COD	TOC	
Basic Blue Sandocry I B- 3G(IA)	0.0	---	---	5.85
	1	17	20	3.14
	2.5	28	28	3.21
	5	60	39	3.30
	10	73	66	3.45
	20	79	81	3.61
	50	87	94	3.61

4.1.2. G-values of Degradation using Gamma Irradiation of Different Dyes in different atmospheres and PH's

Table 2 shows that the irradiation of different dyes in presence of oxygen or H₂O₂ enhances the degradation of such dyes even at low doses. The effect of PH on the G-value is very dependent on the irradiation atmosphere.

TABLE 2. G-VALUES OF DEGRADATION BY γ -IRRADIATION OF VARIOUS DYES WITH DIFFERENT ADDITIVES AT DIFFERENT PH VALUES

Irradiated Dyes	G-Value														
	N2			Air			O2			H2O2			NaOCl		
	pH ₃	pH ₇	pH ₁₀	pH ₃	pH ₇	pH ₁₀	pH ₃	pH ₇	pH ₁₀	pH ₃	pH ₇	pH ₁₀	pH ₃	pH ₇	pH ₁₀
I _A (Basic Blue Dye)	0.9	0.7	1.0	1.1	0.9	1.3	5.4	4.4	5.0	6.9	5.0	5.8	3.8	2.9	2.1
II _A (Basic Blue Dye)	0.5	0.2	0.15	0.7	0.3	0.2	1.6	0.6	0.3	2.0	0.8	0.5	2.4	1.1	0.7
III _A (Basic Blue Dye)	1.75	1.32	0.9	2.5	2.2	1.3	3.1	2.4	1.8	6.4	3.1	1.95	4.5	1.6	1.1

4.2. Photo-catalytic Degradation of Metanil Yellow Dye using TiO₂ polyvinyl alcohol/acrylic acid microgel

Titanium dioxide is one of the most popular and promising materials as a photo-catalyst because it is stable in various solvents under photo-irradiation, commercially available, and easy to be prepared in the laboratory. However, its practical application seems to be limited

for different reasons such as the difficulty to separate these fine photo-catalysts from solution after reaction.

Although, immobilization technique can improve the TiO₂ separation efficiently, it usually decreases the overall photo-catalytic activity comparing to the dispersed TiO₂ due to lowering of the surface-to-volume ratio and partial loss of the active surface sites of photo-catalysts. Therefore, it is necessary to develop a novel synthesis approach to prepare TiO₂ photo-catalysts, which not only have highly photo-catalytic activity, but also can be steadily separated after photo-catalytic reactions. Since the photo-catalytic activity was confined to the surface of the photo-catalytic material, its surface area must be increased to maximize the photo-catalytic efficiency. Micro and nano-spheres are small and have large surface-to-volume ratio and could be readily separated from the solution by filtration or sedimentation.

Since TiO₂ photo-catalytic degradation requires high surface area, attempts is made to design TiO₂- immobilized PVA/AA microgel of high surface area prepared by electron beam irradiation. Exposure of PVA/AA to electron beam irradiation aids to create microgel with crosslinking network structure. The formation of crosslinking network hinders the PVA/AA microgel matrix to dissolve and enhances its resistivity towards degradation during the dye photo-degradation process. On the other hand, the presence of PVA/AA – microgel does not only act as a carrier for TiO₂, but it also acts as dye absorber materials. The entrapment of both TiO₂ and mono azo dye: Metanil Yellow onto PVA/AA – microgel accelerates the degradation rate of the latter.

4.2.1. PVP/AAc- prepared by ionizing Radiation

Chains of polyacrylic acid (PAA) were incorporated into PVA microgel by radiation grafting technique to improve the functionality and gel fraction of PVA microgel. Different amount of (AA /H₂O) (50:50) was absorbed by PVA microgel and exposed to electron beam irradiation at dose of 20 kGy. Immobilization of TiO₂ on the surface of the prepared PVA/AA microgel of composition (90:10) AA–H₂O (50–50) was investigated. The structural changes and photo-catalytic efficiency of the prepared TiO₂/ PVA-AA microgel were studied.

4.2.2. Evaluation of catalytic performance of PVA/AA- TiO₂ as photo-catalysts

The catalytic efficiency of the developed PVA/AA-TiO₂ microgel catalysts was evaluated by the photo-degradation of an azo compound. Metanil Yellow (C₁₈H₁₄N₃O₃SNa) M.W. 375.391 is a water soluble anionic monoazo dye with a sulfonate group, the pH value of its aqueous solution is 2.5. It has been used in solution with other smaller molecular weight yellow acid dyes to increase the intensity of staining. Moreover, it is used as a colorant in wool, nylon, silk, paper, detergent, and biological staining. This dye has been known by its toxicity and carcinogenic nature as well as its presence in wastewater of several industrial wastes such as textile, tannery, soap, cosmetics and polishes...etc. The chemical structure of Metanil Yellow is characteristic by the conjugated structure constructed via azo bond that appears at wavelength of 448 nm.

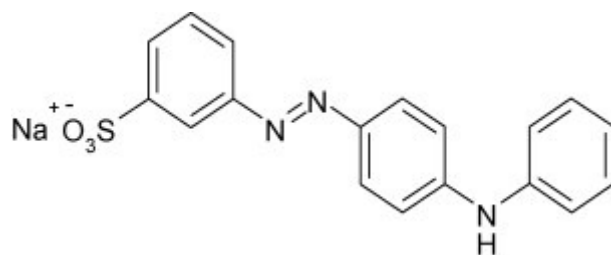

FIG. 3. Chemical formula of Metanil Yellow.

In order to determine the optimal amount of the immobilized TiO_2 catalyst for Metanil Yellow photo-catalytic degradation process, a series of experiments with varied amount of TiO_2 photo-catalyst have been conducted. The amount of the TiO_2 photo-catalyst was varied between 0.1 and 0.5 g/L and compared with P25 standard TiO_2 . Almost complete dye degradation was observed after 180min when PVA/AA- TiO_2 (0.1 g/L) was used as shown in Fig. 4. Meanwhile, it takes 85min when P25 is used at the same concentration. At the beginning of the experiment, the solution without any catalysts was irradiated under UV light to determine to what extent the dye is degraded by UV irradiation in absence of TiO_2 . Thereafter, the TiO_2 immobilized catalyst was subsequently dispersed in the metanil yellow solution under vigorous agitation in dark for 2h. Then the mixture was UV irradiated and separated via centrifugation. The supernatant liquid was measured using UV-vis spectrophotometer Fig. 4.

Fig. 5 shows the effect of the concentration of TiO_2 immobilized into PVA/AA microgel on the dye degradation %. The use of UV/Vis irradiation and TiO_2 free PVA/AA microgel resulted in negligible effect on discoloration of the dye solution. This indicated that the TiO_2 has a significant role as a photo-catalytic reagent where photo-chemical and degradation processes can be occurred. It is clear from Fig. 5 that the degradation of dye using PVA/AA microgel immobilized TiO_2 increases by increasing irradiation time for all TiO_2 photo catalyst concentration. The degree of de-colorization of dye solution increases by the increase in the amount of photo-catalyst, reaching the higher value at catalyst loading of concentration 0.5 g/L. The degradation ratio (%) could be calculated using the equation (1):

$$D = [(C_0 - C_t) / C_0] \times 100 \quad (1)$$

Where, D is degradation ratio, C_0 and C_t are the concentration of dye solution before and after irradiation, respectively.

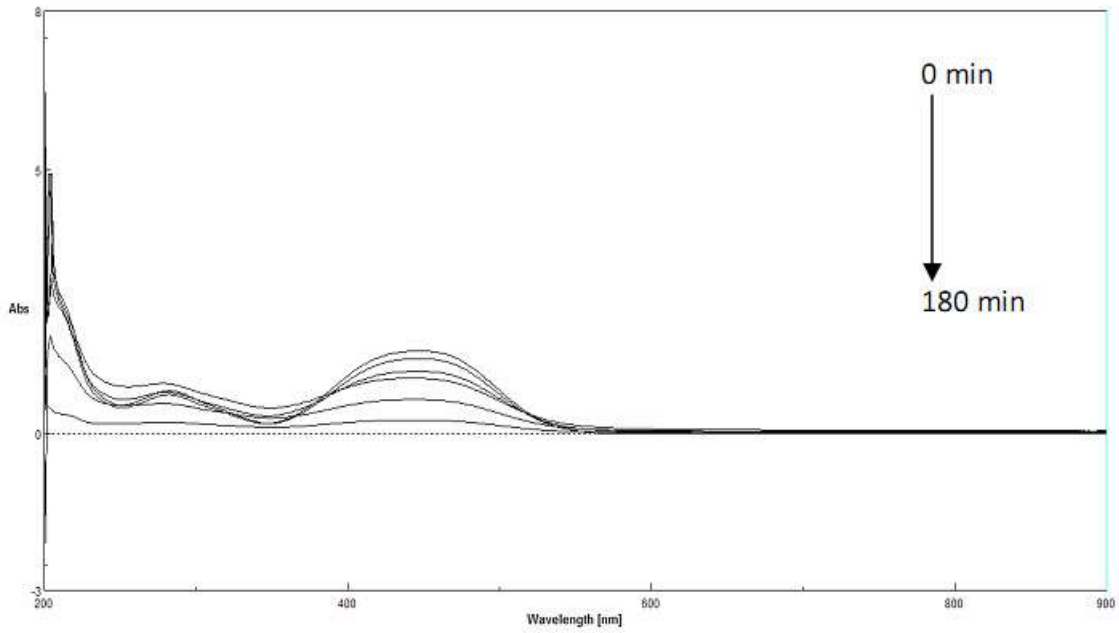

FIG. 4. Uv-vis spectra evolution of metanil yellow solution as a function of uv-irradiation time, tio₂ concentration 0.5 g/l in pva/aa microgel prepared at composition of (90/10) aa:H₂O (50–50).

The most effective decomposition of metanil yellow (90%) was observed with the catalyst amount equal to 0.5g/L. The excess of the immobilized TiO₂ may cause shielding effect and reduces the penetration of the light in the solution after exceeding the optimal amount.

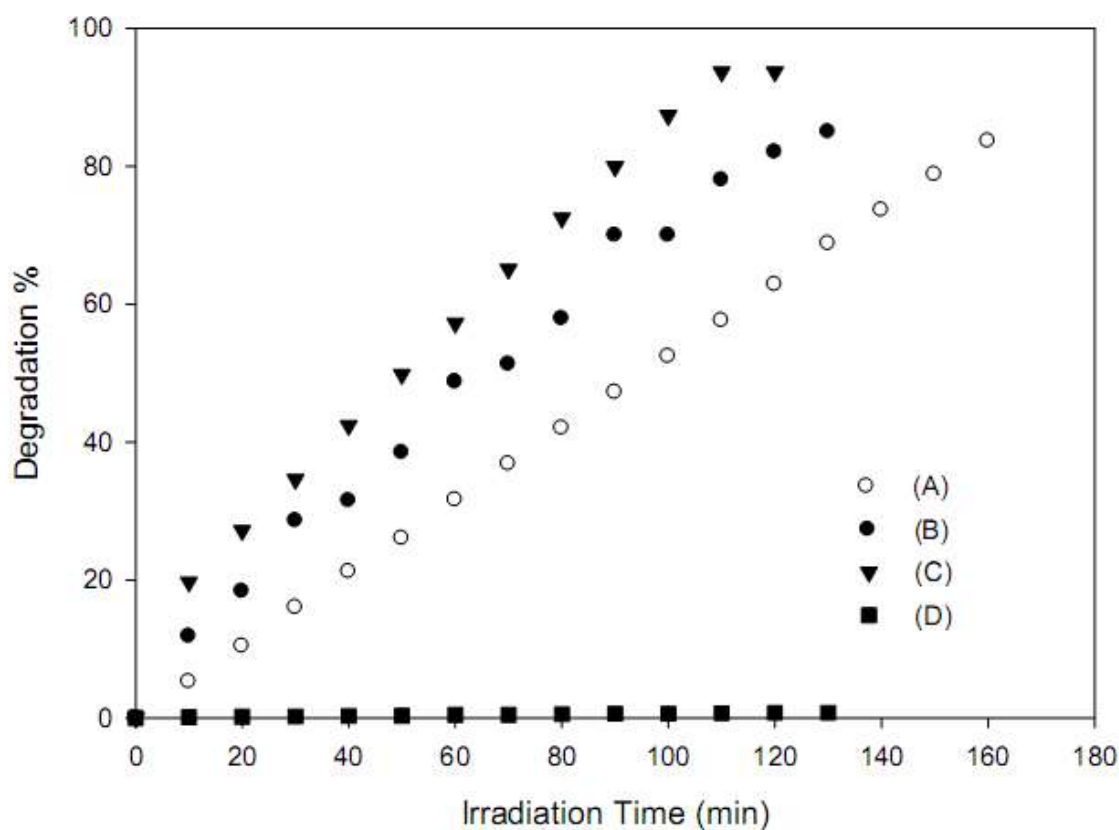

FIG. 5. Degradation of Metanil Yellow in the presence of TiO_2 -(PVA/AA) microgel of different TiCl_4 concentration feed solution (A) 0.1, (B) 0.3, (C) 0.5 and (D) 0 g/L.

4.3. Degradation of Rhodamine B using ionizing radiation

Rhodamine B is a basic red dye of the xanthene class. It is a reddish violet powder which is highly soluble in water forming a red fluorescent solution. It is widely used in smaller concentrations, as a colorant in textiles and food stuffs. It is harmful if swallowed in high concentrations by human beings and animals, and causes irritation to the skin, eyes and respiratory tract.

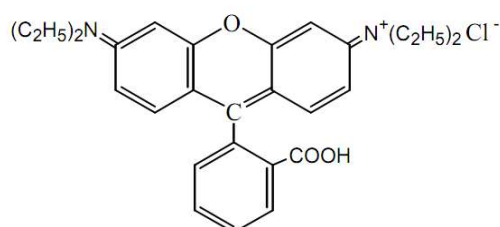

FIG. 6. Chemical structure of rhodamine B.

The carcinogenicity, reproductive and developmental toxicity, neurotoxicity and chronic toxicity towards humans and animals have been experimentally proven. In the present work,

quantitative thin layer chromatography (TLC) has been used as an analytical tool for Rhodamine B solutions determination. At first, the quantitative relation between the concentration of Rhodamine B solutions and the spot area developed in the chromatographic analysis was first determined. Thus, aqueous solutions containing increasing amounts of the dye were prepared and samples were applied on the TLC analytical plate.

4.3.1. Gamma irradiation of aqueous solution of Rhodamine B

A series of experiments were carried out to study the effect of gamma irradiation on the aqueous solution of Rhodamine B dye. It is important to note that the study of the effect of gamma radiations on aqueous dye solution should cover a good range of irradiation doses. So, in the present work the concentration of the dye stock solution used for this study was (14.2mg/50ml). For that purpose, 3 ml aliquots of the dye solution were irradiated at doses ranging from 0–120 kGy at dose rate 0.69 kGy/h. After irradiation, 40 µl from each irradiated solution were applied on TLC plates and were concurrently run with 40 µl sample of the unirradiated dye solution which contain initially 11.4µg of the dye. After development, the spot area weight (SAW) of the analysed spots of dye solution that irradiated with different irradiation doses were measured and the results obtained are given in Table 3 and represented graphically in Fig. 7. From the results obtained it was found that there is a sharp decrease in the SAW from 7.3 mg to 2.5 mg within the dose range 0–20 kGy. On the other hand, there is a gradual decrease in the SAW within the dose range 20–50 kGy. Within the dose range 50–100 kGy, there is a decrease in the SAW from 2.2 mg to 1.1 mg. At about 120 kGy the dye colour completely disappears. Since it is difficult to correlate the data taken from different TLC plates, it was necessary to use the % SAW change vs. gamma irradiation doses to achieve such correlations.

The data obtained are shown in Table 3. From these results it can be observed that the percent colour decay of aqueous solution of Rhodamine B has the shape of a broken line. The first section, which covers the range from 0–15 kGy, shows a marked increase in the percent of colour decay upon increasing the dose,

TABLE 3. % COLOR DECAY OF SAW OF AQUEOUS SOLUTION OF RHODAMINE B (14.2MG/50ML) AT DIFFERENT IRRADIATION DOSES

Irradiation dose (kGy)	2.5	5.0	7.5	10.0	12.5	15.0	20.0	30.0	50.0	70.0	90.0	100	120
Colour decay (%)	8.7	24.6	33.9	47.5	49.8	62.3	65.8	72.6	69.8	76.7	75.0	84.9	100

4.3.2. Effect of oxygen on the radiation decay of Rhodamine B aqueous solution

Different conditions and various additives could affect the radiation decay of Rhodamine B as for example, the presence or absence of oxygen. The effect of oxygen on the decay of Rhodamine B solution was studied in detail. Thus, the dye solution was deaerated by bubbling with N gas for 25 minutes. The aerated and deaerated aqueous dye solutions were irradiated to the required doses 5, 7, 10 and 15 kGy. The effect of irradiation dose on the percent colour decay of the dye was investigated for aerated and deaerated aqueous solutions and the results are shown in Table 4. The correlation coefficient of the data obtained in Table 4 was determined by linear regression analysis and it was found to be 0.8753 and 0.8606 for aerated and deaerated aqueous dye solutions, respectively. The relationship between percent colour decay and irradiation doses are shown in Fig. 7.

TABLE 4. % COLOR DECAY OF AQUEOUS SOLUTIONS OF RHODAMINE B AT DIFFERENT IRRADIATION DOSES UNDER DIFFERENT CONDITIONS

Irradiation dose (kGy)	In presence of air mean value of % colour decay	In absence of air mean value of % colour decay
5	25.9	21.7
7	31	22.2
10	55.5	41.0
15	60.4	46.6

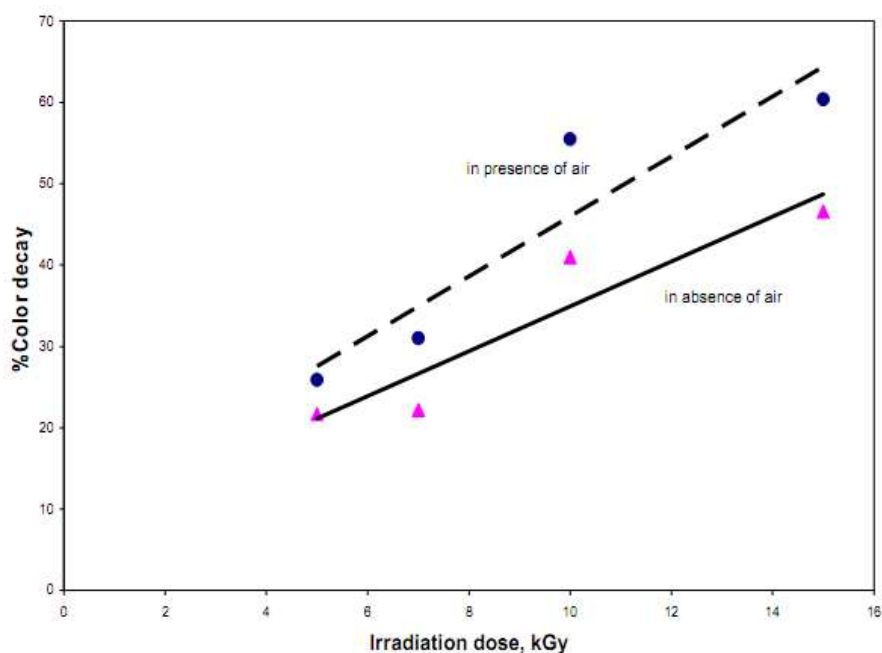
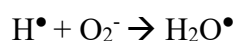
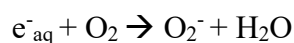

FIG. 7. Relationship between % colour decay of aqueous solution of Rhodamine B and irradiation doses under different conditions A- In presence of air(●) B- In absence of air (Δ).

From these results it is clear that the absence of oxygen decelerates the decay of the dye. For example, at 15 kGy the percent decay was 60.4% and 46.6% for aerated and deaerated aqueous dye solution, respectively. This can be explained by considering the expected contribution HO_2^\bullet and O_2^- radicals which are formed on irradiation according to the following reactions:



This in turn shows that the colour decay of Rhodamine B could probably be favoured by an oxidative mechanism rather than a reductive mechanism.

4.3.3. Proposed mechanism for radiation induced degradation of Rhodamine B dye

Earlier studies concluded that the N-deethylation is considered as the first step in the interaction of Rhodamine B with radiation which causes a delay in the chromophore cleavage step. This indicates that the aromatic rings of Rhodamine B are not broken early during

irradiation; only the big conjugated π -system was destroyed. The ethyl groups of Rhodamine B dye play the role of stabilizing the dye molecules, the deethylated dye molecules are much easier to be decomposed than Rhodamine B molecule. Also, other workers concluded that the N-deethylation process of Rhodamine B is the rate determined step in the degradation of Rhodamine B.

This shows that O_2 promotes dye degradation. On the other hand, in absence of oxygen as an electron acceptor the formation of $Rh\ B^{\bullet}$, which is the intermediate species, in the bleaching process and the formation of $O_2^{\bullet-}/OOH$ is inhibited. Hence, the bleaching process is decreased. This most probably indicates that in deaerated solutions the aromatic rings of Rh B are not broken during irradiation and the big conjugated-system was destroyed as shown by the following Fig. 8.

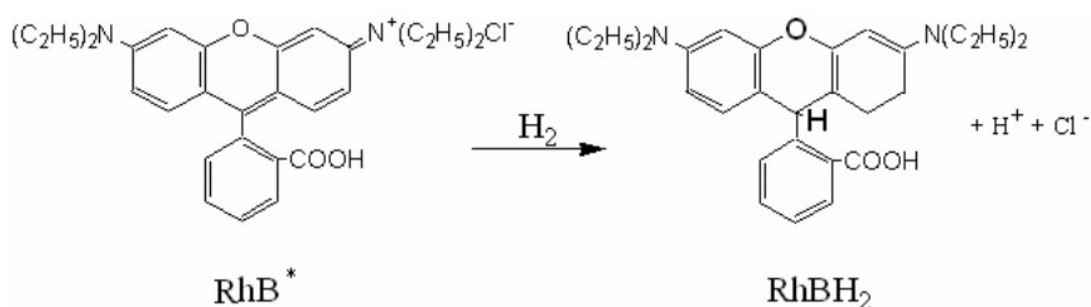

FIG. 8. Radiation induced degradation of Rhodamine B dye.

The deceleration in the colour decay in deaerated solution can be attributed to the decreasing in the rate of decomposition of $RhBH$ compared by RhB^+ , which is obtained in case of aerated solution.

4.4. Radiation Enhancement of Photocatalytic Activity of Conducting Polyaniline– TiO_2 Nanocomposites (PANI- TiO_2) for Degradation of Methyl Orange Dye under Visible Light

In this study, TiO_2 , PANI and PANI/ TiO_2 nanocomposites were prepared. Photocatalytic degradation of methyl orange (MeO) using low amount of PANI/ TiO_2 nanocomposite as a photocatalyst under visible light was investigated. The influence of TiO_2 content, concentration of An, An:APS ratio and different doses of gamma radiation on the photocatalytic activity of the prepared composites were studied. In Fig. 9, an enhancement of the photocatalytic activity of gamma irradiated PANI- TiO_2 nanocomposites is observed. It is known that point defects strongly affect the photocatalytic properties of the photocatalyst. Gamma irradiation may thus have a significant influence in both directions on the photocatalytic activity of TiO_2 , acting through induced defects (mostly Ti^{3+}) on the recombination rate of electron–hole pairs and/or by inhibiting or enhancing formation of oxidizing agents.

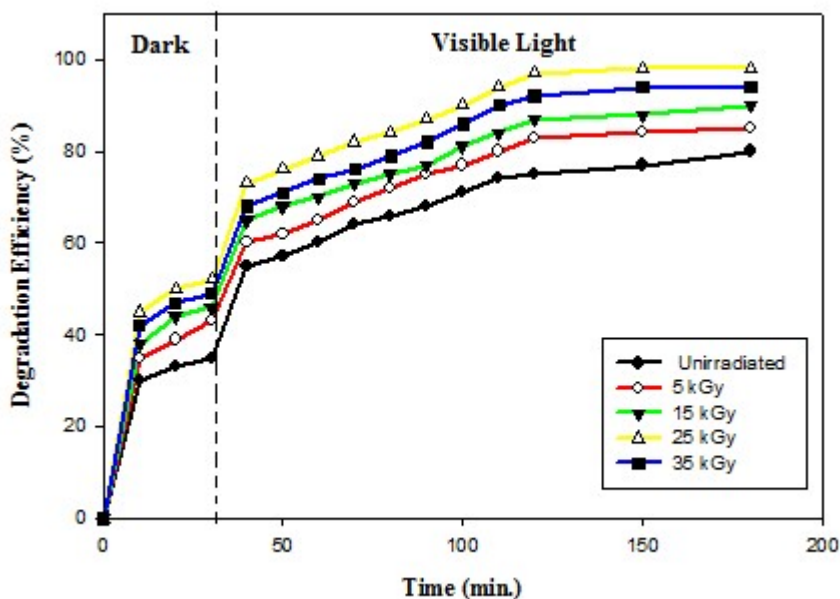

FIG. 9. Photocatalytic degradation of MO in PANi-TiO₂ nanocomposite prepared at TiO₂ 10 wt%, An:APS; 1:1 molar ratio, An, 0.25 M, and different irradiation doses.

4.5. Radiation synthesis of imprinted hydrogels for selective metal ions adsorption from waste water

In this study, an imprinted hydrogel was prepared by gamma-radiation for uptake Pb and Co ions from the aqueous environment. (Acrylamide /2-vinylpyrrolidone) (AAM/NVP) hydrogel was chosen as a matrix for preparing imprinted matrix. The imprinted hydrogel was evaluated for the binding capability towards Pb and Co ions in the aqueous environment and compared with non-imprinted one. Factors such as pH, time and initial metal ions concentration affecting the uptake were investigated. The affinity or selectivity towards Pb and Co ions was also studied. Results showed that the imprinted hydrogels exhibited high affinity towards the template metal ions specially Pb²⁺ (Fig. 10), at any given initial feed concentration. This is very remarkable for the imprinted Pb ions.

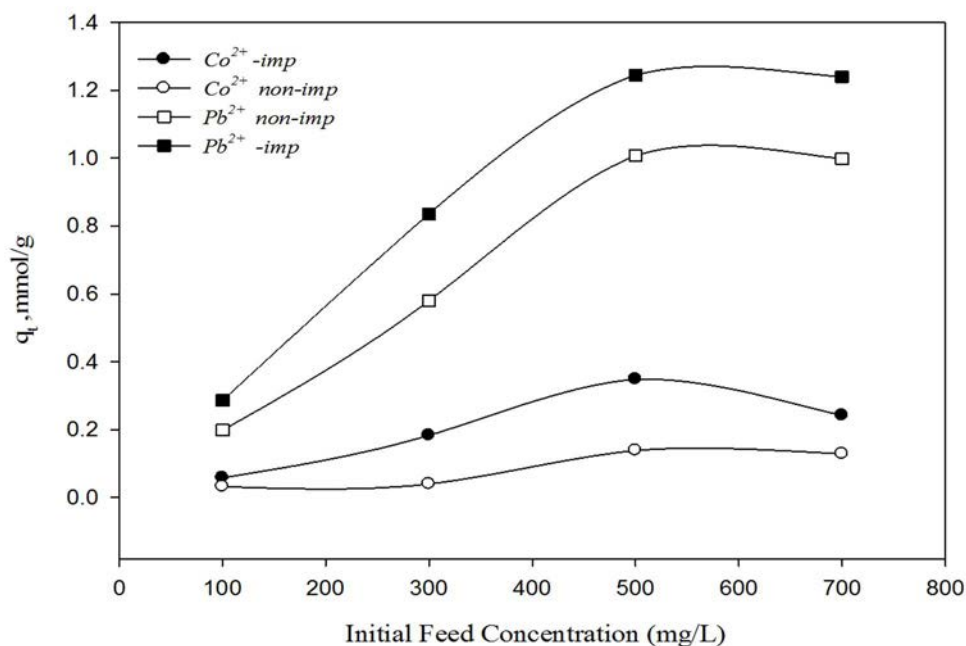

FIG. 10. Effect of initial metal ion feed solution concentration on the adsorption of Co^{2+} and Pb^{2+} at pH:5.

5. SUMMARY

The effect of ionizing radiation on different textile dyes was studied. Almost complete degradation was achieved for low dye concentration (25–50 mg/l) at 1–3 kGy irradiation doses. On the other hand, microgel from PVA/AA was successfully prepared using electron beam irradiation. TiO_2 supported microgel was prepared and investigated for metanil yellow photo-degradation. The efficient photo-catalytic ability of PVA/AA- TiO_2 microgel is reflected in the determined photo bleaching rate of the dye. The practical advantages of direct and ease of removal of the pollutant dyes from the environment by adsorption on the microgel, as well as a better reproducibility of photo-catalytic degradation; makes it a viable technique for the safe treatment of textile wastewater.

The degradation of Rhodamine B dye by gamma irradiation was carried out. The effect of oxygen on the decay of Rhodamine B solution was studied and showed that the absence of oxygen decelerates the decay of the dye. The photocatalytic activity is enhanced for gamma irradiated PANI- TiO_2 nanocomposites in the degradation of methyl orange dyes.

REFERENCES

- [1] MICHAELS, G.B, LEWIS, D.L., Microbial transformation rates of azo and triphenylmethane dyes, *Environ. Toxicol. Chem.* **4**, (1986) 161–166.
- [2] SOLPAN, D., GUVEN, O., High-energy irradiation treatment of aqueous solutions of azo dyes: steady-state gamma radiolysis experiments, *Radiat. Phys. Chem.* **67**, (2003) 531–534.
- [3] AL-MOMANI, F.E., DEGORCE-DUMAS, J.R., ROUSSY, J., THOMAS, O., Biodegradability enhancement of textile dyes and textile wastewater by UV photolysis, *J. Photochem. Photobiol., A: Chem.*, **153**, (2002) 191–197.
- [4] ANLIKER, R., Ecotoxicology of dyestuffs—a joint effort by industry, *Ecotoxicol. Environ. Saf.*, **3**, (1979) 59–74.

- [5] SUGIARTO, A.T., ITO, S., OHSHIMA, T., SATOAND, M., SKALNY, J.D., Oxidative decolouration of dyes by pulsed discharge plasma in water, *J. Electrostat.* **58**, (2003) 135–145.
- [6] VAUTIER, M., GUILLARD, C., HERRMAN, J.M., Photocatalytic degradation of dyes in water: case study of indigo and of indigo carmine, *J. Catal.* **201**, (2001) 46–59.
- [7] SWALLOW, A.J., *Radiation Chemistry of Organic Compounds*, Pergamon, New York. (1960)
- [8] WOJNÁROVITS, L., TAKÁCS, E., Irradiation treatment of azo dye containing wastewater: an overview, *Radiat. Phys. Chem.*, **77**, (2008) 225–244.
- [9] VAHDAT, A., BAHRAMI, S.H., ARAMI, M. MOTAHARI, A., Decomposition and decolouration of a direct dye by electron beam radiation, *Radiat. Phys. Chem.* **79**, (2010)33–35.
- [10] PÁLFI, T., WOJNÁROVITS, L., TAKÁCS, E., *Radiat. Phys. Chem.*, **76**, (2007) 1497–1501.

IONIZING RADIATION INDUCED DEGRADATION OF MONURON IN DILUTE AQUEOUS SOLUTION

E. TAKÁCS^{1,2}, S. HE³, K. KOVÁCS¹, V. MÍLE¹, L. WOJNÁROVITS¹

¹Centre for Energy Research, Hungarian Academy of Sciences

²Faculty of Light Industry and Environmental Engineering, Óbuda University
Budapest, Hungary

³Institute of Nuclear and New Energy Technology (INET), Tsinghua University
Beijing, 100084 China

Abstract

The decomposition of monuron was investigated in dilute aqueous solutions. Pulse radiolysis was used to identify the intermediates and γ -radiolysis to analyse final products. The main reaction takes place between monuron and the hydroxyl radicals yielding hydroxycyclohexadienyl type radicals with a second order rate constant of $(7.4 \pm 0.2) \times 10^9 \text{ mol}^{-1} \text{ dm}^3 \text{ s}^{-1}$. In $\cdot\text{OH}$ reactions, the aminyl and phenoxy radicals may also form. Dechlorination was observed in both hydroxyl radical and hydrated electron reactions. The $\cdot\text{OH}$ induced dechlorination reactions are suggested to occur through OH substitution or phenoxy radical formation. The rate of oxidation is very high in the presence of dissolved oxygen.

1. OBJECTIVE OF THE RESEARCH

Toxic organic compounds e.g. pesticides are detected worldwide in the aquatic environment, it is important to find methods for their decomposition. High-energy radiation (electron beam, EB) treatment is a very effective method for this purpose.

Our objective focused on the ionizing radiation induced decomposition of monuron. The degradation products were identified by various methods and the pulse radiolysis was applied to identify the intermediates.

2. INTRODUCTION

Pollution of surface waters by herbicide residues is a very serious environmental problem. Herbicides are usually highly persistent and their biodegradation may take years due to their slow photodegradation [1]. Phenylurea herbicides are applied in significant amount in both agricultural and non-agricultural fields.

Monuron (3-(4-chlorophenyl)-1,1-dimethylurea) belongs to the class of herbicides. Its decomposition was studied e.g. in photolysis [2-4], in electro-fenton [5], in photo-fenton [6], in H_2O_2 photolysis [6], in photocatalytic [6-8], in photoinduced Fe(III) reactions [7] or in ozonation experiments [9]. In all of these AOPs the degradation of monuron was attributed to the reactions of hydroxyl radicals, as a result of OH-attack N-demethylation on side chain, hydroxylation or OH substitution of a chlorine atom on aromatic ring took place. The high energy radiation induced degradations of diuron and fenuron have already been studied [10-12]. However, no results were found on the radiolytic degradation of monuron.

In this study, decomposition of monuron was investigated with high energy irradiation technique and the intermediate radicals were observed with pulse radiolysis under different

conditions. The final products formed in γ -irradiated air saturated samples were also identified.

3. MATERIALS AND METHODS

All chemicals used in this study were purchased from Spectrum-3D or Carlo Erba. In most of experiments $1 - 10^{-4} \text{ mol dm}^{-3}$ monuron solutions were investigated. The solutions were saturated with the appropriate gases, N_2O , N_2 , or air before irradiation.

Pulse radiolysis investigations were carried out using 800 ns pulses of accelerated electrons and optical detection in 1 cm cell, dose/pulse 20–40 Gy (J kg^{-1}). In this technique, the energy absorption from a short pulse of accelerated electrons initiates the chemical changes. The formation and decay of short-lived transient intermediates is followed by their light absorption in the UV-Vis wavelength range. $\cdot\text{OH}$ formed during the pulse reacts with the solute molecules on longer timescale than the pulse time. Gamma irradiations were carried out by a ^{60}Co facility with 5 kGy h^{-1} dose rate. Experiments were made at room temperature in unbuffered solutions saturated with air or N_2O .

UV-Vis spectra of un-irradiated and irradiated samples were taken by a conventional spectrophotometer (JASCO 550 UV-Vis) with 1 cm cell. Liquid chromatography-mass spectrometry (LC-MS) is the primary analytical tool used to investigate pharmaceuticals in environmental samples; it enables both qualitative and quantitative analyses with detection limits below 1 ng dm^{-3} . The degradation products were separated by an Agilent 1200 liquid chromatograph (LC) equipped with a $5 \text{ mm} \times 100 \text{ mm}$ Phenomenex Kinetex XB-C18 capillary column. Separations were carried out under isocratic condition with 80% aqueous formic acid (0.1%) and 20% pure acetonitrile. Both eluents were filtered through $0.2 \mu\text{m}$ RC-filters. LC-separations were made at 25°C at a flow rate of $0.2 \text{ cm}^3 \text{ min}^{-1}$. The compounds were detected and identified with on-line mass spectrometry (MS). MS experiments were performed at positive or negative ionization mode using an Agilent 6410 triple quadrupole tandem mass spectrometer (MS/MS) with electrospray ionization (ESI). In Multiple Reaction Monitoring (MRM) analyses applied the desired molecular ion is selected by the first quadrupole and collision induced dissociation in the second one produces the distinctive product ions. The fragment ion or ions generated are monitored in the third quadrupole.

The concentration of adsorbable organic halides (AOX) and free chloride ions in solutions were monitored by an AOX equipment and perfectIONTM Combination Chloride Electrode, respectively. Other comprehensive characteristics of the solution, such as Chemical Oxygen Demand (COD), Total Organic Carbon (TOC) and Total Nitrogen (TN) contents were also measured using Behrotest TRS 200 COD system and Shimadzu TOC-VCSN equipment, respectively.

4. RESULTS AND DISCUSSION

4.1. Pulse radiolysis studies

The transient absorption spectrum taken in solution when $\cdot\text{OH}$ reacted with monuron the absorbance in the 300–400 nm range and above 400 nm showed different time dependence (Fig. 1). Above 400 nm the absorbance decayed more slowly than the absorbance at shorter wavelengths. This behaviour showed that during the pulse at least two transient intermediates formed. The one absorbing in the 300–400 nm range may belong to the hydroxycyclohexadienyl radical isomers. In order to check the identification of this peak we

repeated these experiments with $1 \times 10^{-4} \text{ mol dm}^{-3} \text{ K}_3\text{Fe}(\text{CN})_6$ added to the solution. $\text{Fe}(\text{CN})_6^{3-}$ is known to convert hydroxycyclohexadienyl type radicals to the corresponding phenolic compounds [13]. The maximum absorbance in the presence of $\text{Fe}(\text{CN})_6^{3-}$ ions was observed earlier, at 3 μsec and the intensity was much smaller than in solution without these ions. At 30 μsec just a small peak was observed at 350 nm. These findings indicate that the 350 nm absorbance belongs to the hydroxycyclohexadienyl radicals. In $\cdot\text{OH}$ reaction with the ring double bonds two different hydroxycyclohexadienyl radicals may form. End product experiments, in which two ring hydroxylated isomers were detected support this view. At about 310 nm the decrease of absorbance in the presence of $\text{Fe}(\text{CN})_6^{3-}$ is much less than at 350 nm. Certainly, some other species than the hydroxycyclohexadienyl radical also contribute to the absorbance here.

The absorption band above 400 nm may be due to phenoxyl radical or to the aminyl radical. The latter may form by H-abstraction from the $-\text{NH}-$ attached to the ring. Aminyl radical was identified in photoionization experiments with monuron and in the monuron + sulphate radical reaction [3]. The λ_{max} for the aminyl radical is around 435 nm and $\epsilon_{\text{max}} = 2530 \text{ mol}^{-1} \text{ dm}^3 \text{ cm}^{-1}$. In pulse radiolysis of hydroxyanilines the maxima of phenoxyl radical absorbances are around 440 nm [14] and the ϵ_{max} values are $\sim 4000 \text{ mol}^{-1} \text{ dm}^3 \text{ cm}^{-1}$. Based on the absorbance values measured at $\sim 440 \text{ nm}$ we assume that less than 10–20% of $\cdot\text{OH}$ react producing aminyl or phenoxyl radicals.

$\cdot\text{OH}$ may react with the methyl groups on the terminal N-atom by H-atom abstraction [15, 4, 16]. The carbon centred radical that forms in H-abstraction is expected to absorb the light well below 300 nm, this absorbance is blocked by the absorbance of monuron. The products that reflect alterations in the side chain observed here and in other AOPs may serve as a proof for $\cdot\text{OH}$ attack on the side chain. However, based on the intense absorbance of the hydroxycyclohexadienyl radical in the transient spectrum, on the abundance of the ring-hydroxylated products and the highly efficient degradation we assume that addition to the ring with formation of hydroxycyclohexadienyl radicals is the preferred reaction of $\cdot\text{OH}$.

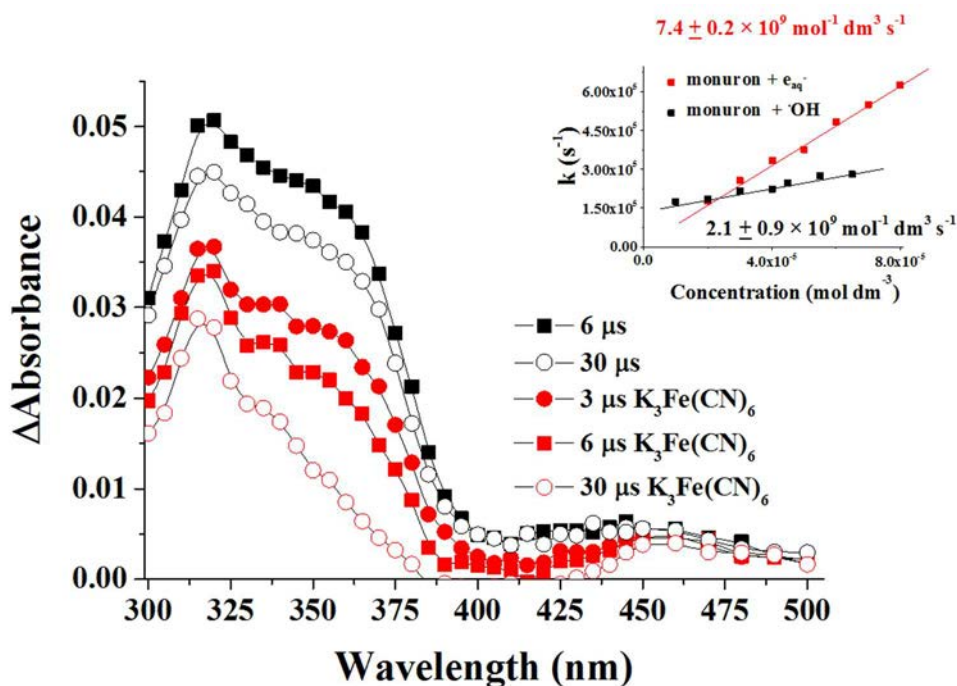

FIG. 1. Transient absorption spectra of 1×10^{-4} mol dm $^{-3}$ N_2O saturated monuron solution 6 and 30 μ s after the pulse, and also with 1×10^{-4} mol dm $^{-3}$ $K_3Fe(CN)_6$ added to the previous solution 3, 6 and 30 μ s after the pulse. Inset: Concentration dependence of the pseudo-first-order rate coefficients of absorbance build-up in the reaction of monuron with $\cdot OH$ and e_{aq}^- .

The rate coefficients of the reactions between monuron and e_{aq}^- , as well as monuron and $\cdot OH$ were determined to be (Fig. 1. Inset): $2.1 \pm 0.9 \times 10^9$ mol $^{-1}$ dm 3 s $^{-1}$ and $7.4 \pm 0.2 \times 10^9$ mol $^{-1}$ dm 3 s $^{-1}$, respectively. Compared to other phenylureas, chlorine atom increases the rate of nucleophile reaction (e_{aq}^-) and decreases that of electrophile reaction ($\cdot OH$) due to electron-withdrawing effect [12, 11]. The rate coefficient for $\cdot OH$ reactions is lower than the diffusion controlled limit (1.1×10^{10} mol $^{-1}$ dm 3 s $^{-1}$, [17]). Based on this, the reaction is not clearly diffusion controlled reaction, the diffusion and chemical activation also influence the reaction [18].

4.2. Chemical oxygen demand, total organic carbon content and total nitrogen content in air saturated solutions

The rate of oxidation and mineralization of the organic content in water may be characterized by COD and TOC removals, while changes of the TN-values give important information on the fate of the N-atoms in the molecule. These measurements were carried out at 1×10^{-4} mol dm $^{-3}$ concentration. The calculated initial COD-, TOC- and TN-values are 31.2 mg dm $^{-3}$ and 10.8 mg dm $^{-3}$ and 2.8 mg dm $^{-3}$, respectively. The measured values, 31 mg dm $^{-3}$, 11.1 mg dm $^{-3}$ and 2.5 mg dm $^{-3}$, respectively, are close to the calculated ones (Fig. 2). When the solutions are irradiated, due to the oxidation, the COD and TOC values decrease. The high efficiency of oxidation is probably due to the high sensitivity of the intermediate radicals to dissolved O_2 , and to the further reactions of peroxides formed in O_2 scavenging [19].

The lower initial slope of the TOC-dose relation compared to that of the COD-dose relation suggests a gradual oxidation. As the oxidation proceeds, the oxygen-to-carbon ratio in the products increases and the pH of the solutions decreases. Formation of smaller molecular

mass carboxylic acids was reported in several AOPs [20]. These compounds degrade slowly in $\cdot\text{OH}$ induced reactions. The deviation of COD from linearity above 5 kGy dose (Fig. 3) may be due to the slow degradation of oxidized smaller molecular fragments.

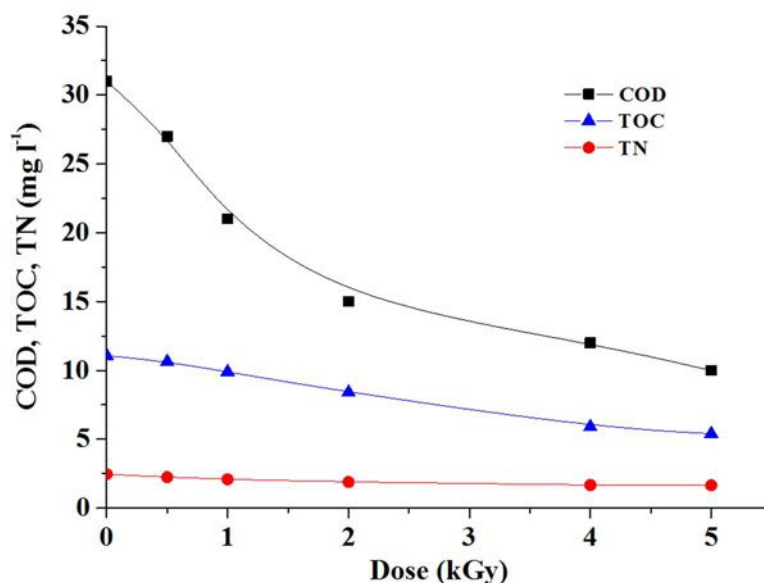

FIG. 2. COD, TOC and TN values measured in $1 \times 10^{-4} \text{ mol dm}^{-3}$ air saturated solution.

TN decreases only slightly with the absorbed dose. This shows that during the treatment the larger part of N-atoms remain in the solution as organic or inorganic nitrogen compounds and does not leaves the liquid in the form of N_2 .

4.3. Chloride release and organic chlorine content

Chloride release is an important indicator of the degradation of chlorinated molecules. It helps to understand the attack of reactive radicals on special sites of the molecule studied. The release of chloride from monuron molecule was observed under all investigated conditions, i.e. in reactions of $\cdot\text{OH}$, $e_{\text{aq}}^- + \cdot\text{CH}_2(\text{CH}_3)_2\text{COH}$, $\cdot\text{OH} + e_{\text{aq}}^-$, $\cdot\text{OH} + \text{O}_2^-/\text{HO}_2$, respectively (Fig. 3). In the first stage of degradation the most intense chloride release was observed in air saturated solution ($0.13 \mu\text{mol J}^{-1}$). Above 4 kGy dose, the percentage of chloride release was considerably higher in $\cdot\text{OH}$ reaction (in N_2O saturated solution) than in reaction of other intermediates. The results obtained in N_2 saturated TBA containing solutions demonstrate that halogenated compounds are particularly sensitive to e_{aq}^- attack. The mechanism of chloride release in $\cdot\text{OH}$ reaction will be discussed later in connection with quantum chemical calculations.

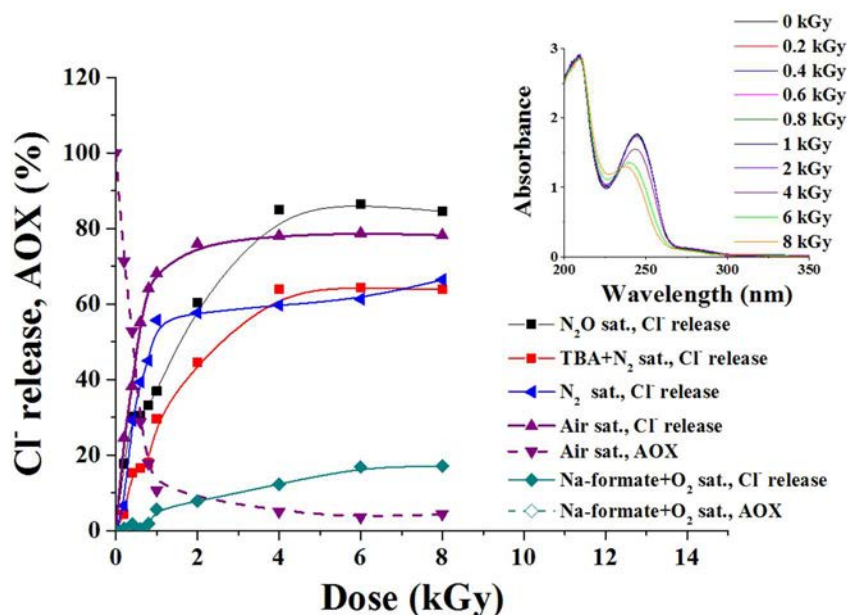

FIG. 3. Chloride release in different solutions and AOX in air saturated solution ($1.1 \times 10^{-4} \text{ mol dm}^{-3}$) and in oxygen saturated Na-formate containing solution. Inset: Absorption spectra of $1.1 \times 10^{-4} \text{ mol dm}^{-3}$ monuron solution irradiated with 0–8 kGy doses, $\text{O}_2^{\cdot-}/\text{HO}_2^{\cdot}$ reaction.

The intensive chloride release in aerated solution reflects the effect of dissolved O_2 . The nature of this enhancing effect is not known, and at present we can give only some speculations. When dissolved O_2 is present e_{aq}^- and H^{\cdot} are transformed to the $\text{O}_2^{\cdot-}/\text{HO}_2^{\cdot}$ pair. In order to check the possibility of $\text{O}_2^{\cdot-}/\text{HO}_2^{\cdot}$ reaction with monuron we conducted investigations in O_2 saturated Na-formate containing solutions. During radiolysis of such solutions all intermediates transform to the $\text{O}_2^{\cdot-}/\text{HO}_2^{\cdot}$ pair [21].



The absorption spectra taken in O_2 saturated Na-formate containing solutions showed a decrease at the $\lambda_{\text{max}} \approx 245 \text{ nm}$ with the increase of the absorbed dose and the place of the maximum slightly shifted to shorter wavelength (Fig. 3., Inset).

These spectral changes are consistent with reductive dechlorination of monuron. However, the effect was very small and it was observed only at high doses. Although, $\text{O}_2^{\cdot-}$ is a reductive radical with standard reduction potential of -0.33 V vs. NHE , the small effect may also be due to not complete scavenging of $\cdot\text{OH}$ and e_{aq}^- by HCO_2^- and O_2 , respectively, and thereby to dechlorination by the escaped intermediates.

4.4.LC–MS results

The end-product identifications were carried out on samples irradiated with 0.5 kGy dose in air saturated solutions.

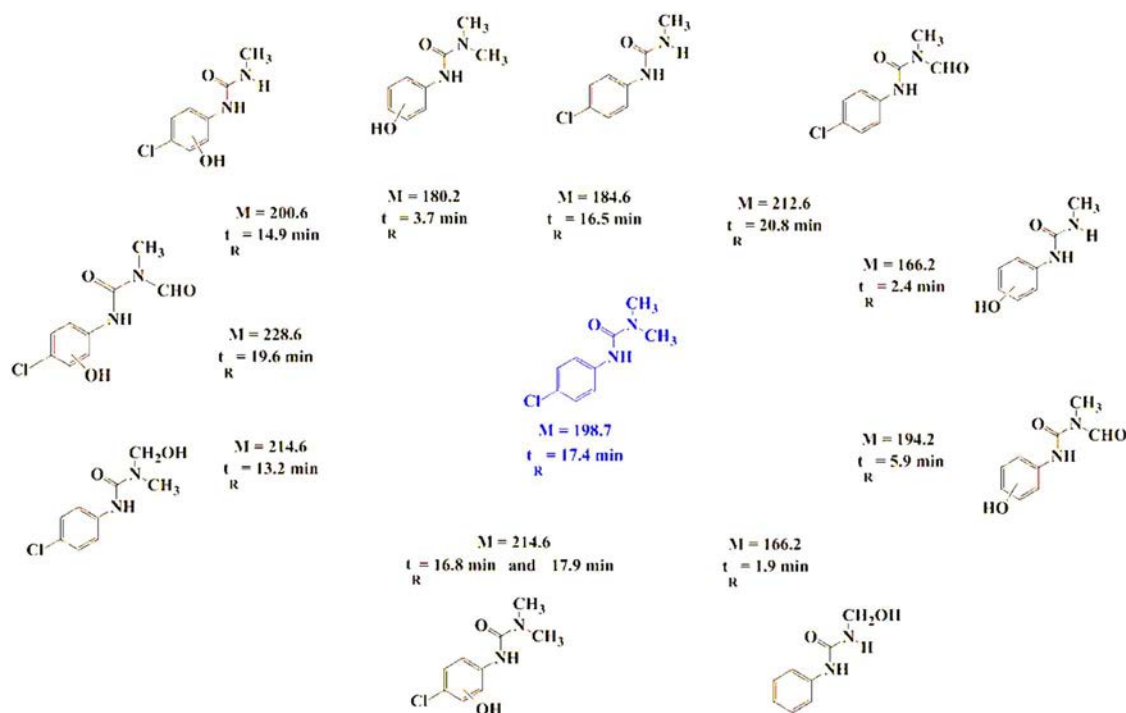

FIG. 4. Monuron and degradation products with molecular weights and elution times.

10 products were identified (Fig. 4) in positive and/or negative ionization modes based on molecular ions and fragmentation patterns. Most of the products were detected in both modes. Monuron and the structural formulas of the products together with the elution times and molecular weights are shown in Fig. 4. The majority of the products have already been identified in other studies after treated with different AOPs using $\cdot\text{OH}$ as reactive agent [6, 8, 7, 22, 9, 2].

Monuron appeared at an elution time of 17.4 min. Most of the products eluted earlier than monuron except for compounds with elution times 17.9, 19.6 and 20.8 min. It is worth to notify that the OH group is attached to the carbon atom on the terminal N-atom in the case of the peak at 13.2 min. Similar fragment was also observed in the radiolytic degradation of fenuron and diuron [12, 11]. In thermal degradation of phenylureas, compounds with isocyanate structure ($\text{Ph}-\text{N}=\text{C}=\text{O}$) [23] were observed. Ions with isocyanate structure form also in the collision chamber of the mass spectrometer, the compounds eluting at 14.9, 16.8, 17.9 and 19.6 min all have a characteristic fragment at m/z 168 in negative ionization mode ($-\text{OCIC}_6\text{H}_3-\text{N}=\text{C}=\text{O}$). All these molecules are hydroxylated in the ring. The peaks at 16.8 and 17.9 min were identified as hydroxylated versions of monuron. The compounds at 13.2, 16.5 and 20.8 min reflect H-abstraction from the methyl groups followed by OH-substitution, demethylation or carbonylation, respectively. Dehalogenated, hydroxylated compounds with elution time 1.9, 2.4, 3.7 and 5.9 min are more polar than starting molecule due to the presence of OH group. The position of OH group on the aromatic ring could not be identified only based on the MS fragmentation pattern. Further structure determination techniques would be needed to the identification of hydroxylated isomers (*ortho*, *meta*, *para*).

During the decomposition of monuron, $\cdot\text{OH}$ reacts with both the aromatic ring and the methyl groups on the terminal N-atom. Based on the distribution of products, addition to the aromatic ring is the main process and H-abstraction has a little contribution to the reaction with monuron. The presence of dehalogenated products in the solutions has already been

proved by chloride release measurements. Transient radical transformation to peroxy radicals is known to have a key role in the phenol type products formation and ring fragmentation in the presence of dissolved oxygen [11].

5. SUMMARY

High energy irradiation is an effective method for the decomposition of monuron in dilute aqueous solution. The main reaction partner is $\cdot\text{OH}$ in air saturated solution forming hydroxycyclohexadienyl type radical. During these reactions, phenoxy and aminyl radicals may also form. The decomposition of monuron can be characterized by hydroxylation and dechlorination processes based on the final products. The electron-withdrawing effect of chlorine atom and the presence of dissolved oxygen promotes both the rate of oxidation and the efficiency of the decomposition. The chlorine atom increases also the reaction rate coefficient between monuron and e_{aq}^- . e_{aq}^- also contributes to the dechlorination processes. According to quantum chemical calculations, in the $\cdot\text{OH} + \text{monuron}$ system, the *para*-reaction is the most favourable thermodynamically and results in dechlorination without formation of hydroxycyclohexadienyl type radical. Solvation has an important role in determining the directions of reactions. Dechlorination processes may take place through OH/Cl substitution followed by H-atom elimination and phenoxy radical formation.

ACKNOWLEDGEMENT

The authors thank Hungarian Science Foundation (OTKA, NK 105802), the Swiss–Hungarian project (No SH7/2/14) and International Atomic Energy Agency (Contract No. 16485 and HUN8008) for the support. International Atomic Energy Agency is thanked for financing scientific training of Dr. He. University of Szeged is thanked for AOX measurements.

REFERENCES

- [1] BRAHMIA, O., BOULKAMH, A., SEHILI, T., AGUER, J.-P., RICHARD, C., Kinetics of photocatalytic decomposition of Fenuron over TiO_2 in aqueous solution. *International Journal of Photoenergy* **4**, (2002) 85–89.
- [2] NÉLIEU, S., SHANKAR, M.V., KERHOAS, L., EINHORN, J., Phototransformation of monuron induced by nitrate and nitrite ions in water: Contribution of photonitration. *Journal of Photochemistry and Photobiology A: Chemistry*, **193**, (2008) 1–9.
- [3] CANLE LÓPEZ, M., RODRÍGEZ, S., RODRÍGEZ VAZQUES, L.F., SANTABALLA, J.A., STEENKEN, S., First stages of photodegradation of the urea herbicides Fenuron, Monuron and Diuron. *Journal of Molecular Structure*, (2001) 565–566, 133–139.
- [4] CANLE LÓPEZ, M., FERNANDEZ, M.I., RODRÍGEZ, S., SANTABALLA, J.A., STEENKEN, S., VULLIET, E., Mechanisms of direct and TiO_2 -photocatalysed UV degradation of phenylurea herbicides. *ChemPhysChem* **6**, (2005) 2064–2074.
- [5] OTURAN, M.A., EDELAHI, M.C., OTURAN, N., EL KACEMI, K., AARON, J.-J., Kinetics of oxidative degradation/mineralization pathways of the phenylurea herbicides diuron, monuron and fenuron in water during application of the electro-Fenton process. *Applied Catalysis B: Environmental*, **97**, (2010) 82–89.
- [6] BOBU, M., WILSON, S., GREIBROKK, T., LUNDANES, E., SIMINICEANU, I., Comparison of advanced oxidation processes and identification of monuron photodegradation products in aqueous solution. *Chemosphere* **63**, (2006) 1718–1727.
- [7] MĚŠT'ANKOVÁ, H., MAILHOT, G., PILICHOWSKI, J.-F., KRYSA, J., JIRKOVSKY, J., BOLTE, M., Mineralisation of monuron photoinduced by Fe(III) in aqueous solution. *Chemosphere*, **57**, (2004) 1307–1315.
- [8] CHU, W., RAO, Y. F., Photocatalytic oxidation of monuron in the suspension of WO_3 under the irradiation of UV-visible light. *Chemosphere*, **86**, (2012) 1079–1086.

- [9] TAHMASSEB, L.A., NÉLIEU, S., KERHOAS, L., EINHORN, J., Ozonation of chlorophenylurea pesticides in water: reaction monitoring and degradation pathways. *Science of the Total Environment*, **291**, (2002) 33–44.
- [10] ZHANG, J., ZHENG, Z., ZHAO, T., ZHAO Y., WANG, L., ZHONG, Y., XU, Y., Radiation-induced reduction of diuron by gamma-ray irradiation. *Journal of Hazardous Materials*, **151**, (2008) 465–472.
- [11] KOVÁCS, K., HE, S., MILE, V., CSAY, T., TAKÁCS, E., WOJNÁROVITS, L., Ionizing radiation induced degradation of diuron in dilute aqueous solution. *Chemistry Central Journal*, **9:21**, (2015) DOI: 10.1186/s13065-015-0097-0.
- [12] KOVÁCS, K., MILE, V., CSAY, T., TAKÁCS, E., WOJNÁROVITS, L., Hydroxyl radical-induced degradation of fenuron in pulse and gamma radiolysis: kinetics and product analysis. *Environmental Science and Pollution Research*, **21**, (2014) 12693–12700.
- [13] BUXTON, G.V., LANGAN, J.R., SMITH, J.R.L., Aromatic hydroxylation. 8. A radiation chemical study of the oxidation of hydroxycyclohexadienyl radicals. *Journal of Physical Chemistry* **90**, (1986) 6309–6313.
- [14] SINGH, T.S., GEJJI, S.P., RAO, B.S.M., MOHAN, H., MITTAL, J.P., Radiation chemical oxidation of aniline derivatives. *Journal of the Chemical Society, Perkin Transactions*, **2**, (2001) 1205–1211.
- [15] RICHARD, C., BENGANA, S., PH effect in the photocatalytic transformation of a phenyl-urea herbicide. *Chemosphere*, **33**, (1996) 635–641.
- [16] MAZELLIER, P., BUSSET, C., DELMONT, A., DE LAAT, J., A comparison of fenuron degradation by hydroxyl and carbonate radicals in aqueous solution. *Water Research*, **41**, (2007) 4585–4594.
- [17] WOJNÁROVITS, L., TAKÁCS, E., Rate coefficients of hydroxyl radical reactions with pesticide molecules and related compounds: A review. *Radiation Physics and Chemistry*, **96**, (2014) 120–134.
- [18] ASHTON, L., BUXTON, G. V., STUART, C. R., Temperature dependence of the rate of reaction of OH with some aromatic compounds in aqueous solution. *Journal of the Chemical Society, Faraday Transactions* **91 (11)**, (1995) 1631–1633.
- [19] HOMLOK, R., TAKÁCS, E., WOJNÁROVITS, L., Degradation of organic molecules in advanced oxidation processes: relation between chemical structure and degradability. *Chemosphere* **91**, (2013) 383–389.
- [20] OTURAN, M., MOHAMED, C., OTURAN, N., EL KACEMI, K., AARON, J.J. (2010). Kinetics of Oxidative Degradation/Mineralization Pathways of the Phenylurea Herbicides Diuron, Monuron and Fenuron in Water during Application of the Electro-Fenton Process. *Applied Catalysis B: Environmental*. 97. 82-89. 10.1016/j.apcatb.2010.03.026.
- [21] BIELSKI, B.H., CABELLI, D.E., ARUDI, R.L., ROSS, A.B., Reactivity of HO₂/O₂-• radicals in aqueous solution. *Journal of Physical Chemistry Reference Data* **14**, (1985) 1041–1100.
- [22] KRYSA, J., WALDNER, G., MĚŠT'ÁNKOVÁ, JIRKOVSKY, J., GRABNER, G., Photocatalytic degradation of model organic pollutants on an immobilised articulate TiO₂ layer. Roles of adsorption processes and mechanistic complexity. *Applied Catalysis B: Environmental*, **64**, (2006) 290–301.
- [23] SALVESTRINI, S., DI CERBO, P., CAPASSO, S., Kinetics of the degradation of diuron. *Chemosphere*, **48**, (2002) 69–73.
- [24] BUXTON, G.V., GREENSTOCK, C.L., HELMAN, W.P., ROSS, A.B., Critical review of rate constants for reactions of hydrated electrons, hydrogen atoms and hydroxyl radicals (•OH/O⁻) in aqueous solution. *Journal of Physical Chemistry Reference Data* **17**, (1988) 513–886.

AOP DEGRADATION OF EMERGING ORGANIC CONTAMINANTS: IONIZING RADIATIONS, ULTRASOUNDS, UV-TiO₂ HYBRID TECHNIQUES AND THEIR SCALE-UP

M. SARACINO^{1, 2}, S. MONTANARI^{1, 2}, M.L. NAVACCHIA¹, M.L. CAPOBIANCO¹, B. ESPOSITO¹, S.S. EMMI¹, A. ZANELLI¹

¹Consiglio Nazionale delle Ricerche (CNR)

Istituto per la Sintesi organica e la Fotoreattività (ISOF) and Proambiente s.c.r.l.

101, Via P. Gobetti, 40129 Bologna

²University of Bologna, Dept. of Industrial Chemistry "T. Montanari"

4, viale Risorgimento, 40136 Bologna

Italy

Abstract

Emerging organic contaminants are becoming a concern because they pass through the regular wastewater treatment plants. Ultraviolet disinfection plants could be easily implemented to advanced oxidation processes by adding appropriate photo-catalysts, enhancing lamp power, and coupling them to ultrasound. Several emerging contaminants (ofloxacin, diclofenac, carbamazepine, benzophenone-3, benzophenone-4, and triton X-100) among the most frequently detected in the environment have been selected on the base of their chemical characteristics. Lab-scale tests with electron-beam, ultraviolet light (9 W), ultrasounds (37 or 80 kHz and 30 – 120 W), and TiO₂ micropearls (10–100 mg L⁻¹) have been carried out in order to evaluate cost-benefit of these synergetic techniques. The processes, initiated both by electron-beam and γ -rays on ofloxacin or on a multi-component solution, show that pollutants are removed according to a first order process vs. dose. The mineralization process demonstrated to be equally feasible both under fully oxidative (H₂O₂ present) and under simultaneous oxidative-reductive conditions (no additive), although electron-beam process shows a lesser mineralization efficiency than γ -treatment. By controlling dose rate and/or by adding H₂O₂, the dose was changed over 7 orders of magnitude. By using ultrasounds and UV-TiO₂, the full degradation of the contaminants has been achieved but the mineralization was poor. The energy consumption of ultrasounds does not justify the increasing of the degradation. A 5 L photo-reactor equipped with ultraviolet lamps (144 W), about 0.25 m² TiO₂, and a recycle pump has been built and tested reaching 38% of mineralization in 6 hours.

1. OBJECTIVE OF THE RESEARCH

General objective of the activity of our group is the comparison of Advanced Oxidation Processes (AOPs) regarding the organic contaminants that are of main concern in Italy [1]. The first objective of this research was the understanding of the degradation kinetic of ofloxacin in neutral water and the mineralization of complex mixtures by using electron beam (EB) or γ -rays. The second one was the investigation on the synergetic effect of ultrasounds on the photo-catalysis under ultraviolet irradiation. The third objective was the scale-up of a photo-catalytic AOP from the lab-scale (~1 L) to the scale for the validation in a relevant environmental (~10 L) in agreement with the Technical Readiness Level 5 of the Horizon 2020 EU program.

2. INTRODUCTION

At the end of our previous report [2], we described the contemporary degradation of five organic emerging contaminants (EOC) in water solution, called MIX5, containing: carbamazepine (CBZ), diclofenac (DCF), benzophenone-3 (BP3), benzophenone-4 (BP4), and triton X-100 (TRX); both in deionized and tap water by means of ~ 254 nm ultraviolet (UV) photolysis, UV/H₂O₂ and UV/TiO₂ AOPs. These five EOCs have been selected, besides including some of the most frequently detected pollutants, as representative of categories with different interactions to water, and different chemical groups.

BP3 and BP4 are two of the most commonly used UV filters in personal care products and they have been found in untreated municipal wastewater in different countries at concentrations between 1.5 and 19 $\mu\text{g L}^{-1}$ [3]. Their occurrence both in water [4] and in sediments [5] raises concern regarding possible estrogenic effects. They have similar structures, good stability to the light [6], but different solubility.

CBZ is an anticonvulsant used in the treatment of epilepsy and bipolar disorder. Globally, it is the most frequently detected pharmaceutical residue in surface water (in Italy concentrations up to 0.35 $\mu\text{g L}^{-1}$ has been found in the Po River [7]) because its removal efficiency in wastewater treatment plants is less than 10% [8]. The higher concentration detected in the effluent of a pharmaceutical factory was 0.84 mg L^{-1} [9]. CBZ is a neutral molecule containing two tertiary amines.

DCF is a non-steroidal anti-inflammatory agent recently included by the European Commission in the “watch list” of the substances to be monitored in surface waters (Directive 39/2013/EU). Many studies found DCF concentrations $> 1 \mu\text{g L}^{-1}$ in wastewater treatment plants effluents [10] and the highest concentration detected was 0.2 mg L^{-1} [11]. DCF is a sodium salt that shows spontaneous photolysis in the environment with half-lives from 0.19 to 0.27 hours [12].

Finally, TRX is non-ionic surfactant widely used in many liquid, paste, and powdered cleaning formulations, ranging from heavy-duty industrial and agrochemical products to gentle detergents [13]. It is poorly biodegradable compound [14] whose residues are suspected to be endocrine disrupting agents [15].

In the IAEA-TECDOC [16], we reported on a water solution of BP3, BP4, CBZ and ofloxacin (OFX) for a wide study regarding: UV irradiation alone, UV irradiation in the presence of TiO₂, UV irradiation in the presence of H₂O₂, γ -rays in the presence of H₂O₂, EB with and without the presence of H₂O₂. OFX is a fluoroquinolone antibiotic whose photo-chemical degradation has been widely studied [17], it has been frequently detected in Po River with concentrations up to 0.31 $\mu\text{g L}^{-1}$ reaching the fifth place after CBZ. Table 8.1 lists the model EOCs used in the present study.

TABLE 1. MODEL EOCs

Name	CAS #	m. w. (g mol^{-1})
benzophenone-3 (BP3)	131-57-57	228.24
benzophenone-4 (BP4)	4065-45-6	308.31
carbamazepine (CBZ)	298-46-4	283.27
diclofenac (DCF)	15307-79-6	296.15
triton X-100 (TRX)	9002-93-1	625 (average)
ofloxacin (OFX)	82416-36-1	361.37

AOPs, and the less investigated Advanced Reduction Processes (ARPs), can be successfully used as tertiary treatments to degrade the bio-refractory EOCs [18, 19]. AOPs and ARPs can both be started by ionizing radiations or non-ionizing radiations: AOPs fund their action on the oxidizing properties of the $\cdot\text{OH}$ radical, ARPs make use of the reducing power of the hydrated electron and hydrogen atom (e_{aq}^- , $\cdot\text{H}$). Together, they actually appear to satisfy the need of decomposing organic material. Secondly, they can be engineered to multi-scale water loads, which properly respond to the claims of a wastewater remediation involving industrial and municipal effluents. A more or less ample literature exists about the degradation of OFX [20-23], CBZ [24, 25], and BP3 [26-31] while only rare examples are reported for BP4 [28]. However, with some exceptions, these studies refer to the degradation of single component rather than of complex systems, leaving a certain degree of uncertainty when the conclusions are to be transferred to the behaviour of real systems. In fact, in the core of the oxidation/reduction process regarding a complex system, several contaminants, and their often unknown metabolites, compete for the same reactants leading to unexpected results.

The classification of a process as solely *oxidative* or solely *reductive* seems to be often unable to conceive an acceptable mechanism, and raises inappropriate expectations about the structures of intermediates. As a matter of fact, oxidized products form side-by-side with reduced ones in some widely diffuse treatment methods, as photo-catalysis and water radiolysis.

In photo-catalysis holes and electrons are generated, which can separate and diffuse at the water/molecule interface, where they can start oxidations and reductions, respectively. Also, the adsorption/desorption processes at the catalyst surface raise doubts that a neat oxidation or reduction process is possible.

In water radiolysis oxidizing and reducing species are simultaneously produced in almost equivalent yields, however well-defined operative conditions are known to activate a neat oxidation or a neat reduction or as a combination of both (hybrid process).

3. EXPERIMENTAL SECTION AND DISCUSSION

3.1. Materials and analytical methods.

BP3, BP4, CBZ, DCF, OFX and TRX were supplied by Sigma–Aldrich. OFX solutions were in the range 8 – 25 mg L⁻¹, mixed solutions were about 5 mg L⁻¹ per each EOC. Their complete dissolution in water was achieved by magnetically stirring for 48 hours in the dark. H₂O₂ (30% v/v) solution was purchased from Merk KGaA. TiO₂ VP Aeroperl P25/20 from Evonik, was a mixture of 80% anatase and 20% rutile with an average particle size of 30 μm and a reactive surface area of (50 ± 15) m² g⁻¹. Ultrapure water was from a Millipore Milli-Q system. 50 MΩ cm⁻¹.

An Agilent 1260 HPLC instrument equipped with a diode array detector was used to follow the disappearance of compounds. 0.5 mL samples were used as sources for the automated injection of 40 μL of each chromatographic run performed on a reverse phase C-8 poroshell (Agilent) 120, 2.1×50 mm, 2.7 μm, or a reverse phase Zorbax C8 column 4.6×150 mm, 5 μm, with a linear gradient from 0.1% trifluoroacetic acid in water to 100% acetonitrile; flow rate was 0.5–1 mL min⁻¹. The total organic carbon (TOC) was measured by means of the Hach-Lange LCK-385 test-in-cuvette and DR5000 spectrophotometer. Its limit-of-detection is 3 mg L⁻¹ as declared by the manufacturer. UV-vis spectra have been recorded by a Perkin-Elmer Lambda 45 spectrophotometer. The pH was checked using an Orion Research Expandable Ion analyzer

EA940 equipped with a Hanna Instruments HI1111 electrode. The O₂ saturation has been measured with a Hach-Lange Multi equipped with LOD fluorescence sensor.

3.2. Ionizing radiations

The degradation of OFX was followed in a single solute solution as well, to focus *whether* and *which* new factors may influence the course of the process in the complex system containing BP3, BP4, CBZ and OFX, which will be named MIX4 in the following. In the study, the decomposition process was always due to the activity of the radicals formed with the following yields of the species produced by the absorption of 1 Gray (Gy, the energy spent by making 1 Joule of work on 1 kg of matter) of energy by water [32]: e_{aq}⁻ (0.28 μmol J⁻¹), •OH (0.28 μmol J⁻¹), •H (0.06 μmol J⁻¹), H₂O₂ (0.07 μmol J⁻¹), H₂ (0.05 μmol J⁻¹), H₃O⁺ (0.28 μmol J⁻¹). For a typical radiolysis conducted in pure water, •OH and e_{aq}⁻ are formed with the same yield, then oxidation and reduction are operating the destruction of contaminants through parallel pathways. Therefore, our investigation was intended to evaluate the different level of performances of the neat oxidation process on one side and of the simultaneous action of the oxidizing and reducing radicals on the other.

Irradiation was done in a Nordion 220 ⁶⁰Co gamma-cell at dose rates of 4.5 or 5 Gy min⁻¹ depending on the geometry of the polyethylene reaction cells. EB was exploited with the ISOF 12 MeV Linac with 2 μs pulses at a dose rate of 2.5 mGy s⁻¹. Dosimetry was done with the Fricke dosimeter both for γ and EB experiments. The oxidizing process was optimized by adding H₂O₂ 10 mmol L⁻¹ to convert the hydrated electron into •OH, in this case a G(_{•OH}) = 0.52 μmol J⁻¹ was taken. H₂O₂ was always added all at once immediately before the experiments. Irradiations have been carried out under air bubbling condition.

Air bubbling was continuously operated during the treatment to supply the solution for the amount of oxygen depleted by irradiation. In the EB case, as the energy deposition rate could exceed that of oxygen replenishment, local anoxic conditions might have occurred. This is not the same case of γ-treatments, being the dose rate much lower. Further investigation has been planned.

Both γ- and EB-treatments of MIX4 were exploited in two different chemical systems: i) fully oxidizing conditions (only •OH present) and ii) simultaneous oxidative and reductive conditions (both •OH and e_{aq}⁻ presents). Reminding that oxidizing and reducing species are formed approximately with the same yield before reported, fully oxidizing conditions can be conveniently obtained by converting e_{aq}⁻ into •OH, by the addition of 10 mmol L⁻¹ H₂O₂ (reaction 1).

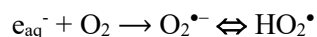
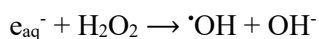

Only few examples of this investigation are here reported. Fig. 1 shows the experiments carried out to assess the decomposition rate order of a single component *vs.* that of a multi-component system. The change of conditions does not affect the deconstruction rate in gamma. The analogous statement in EB cannot be firmly done, as an interaction between OFX and BP4 is suspected to affect the reading of their spectral data in the oxidative/reductive conditions. However, this interaction disappears in the presence of H₂O₂, suggesting the same behaviour observed in γ.

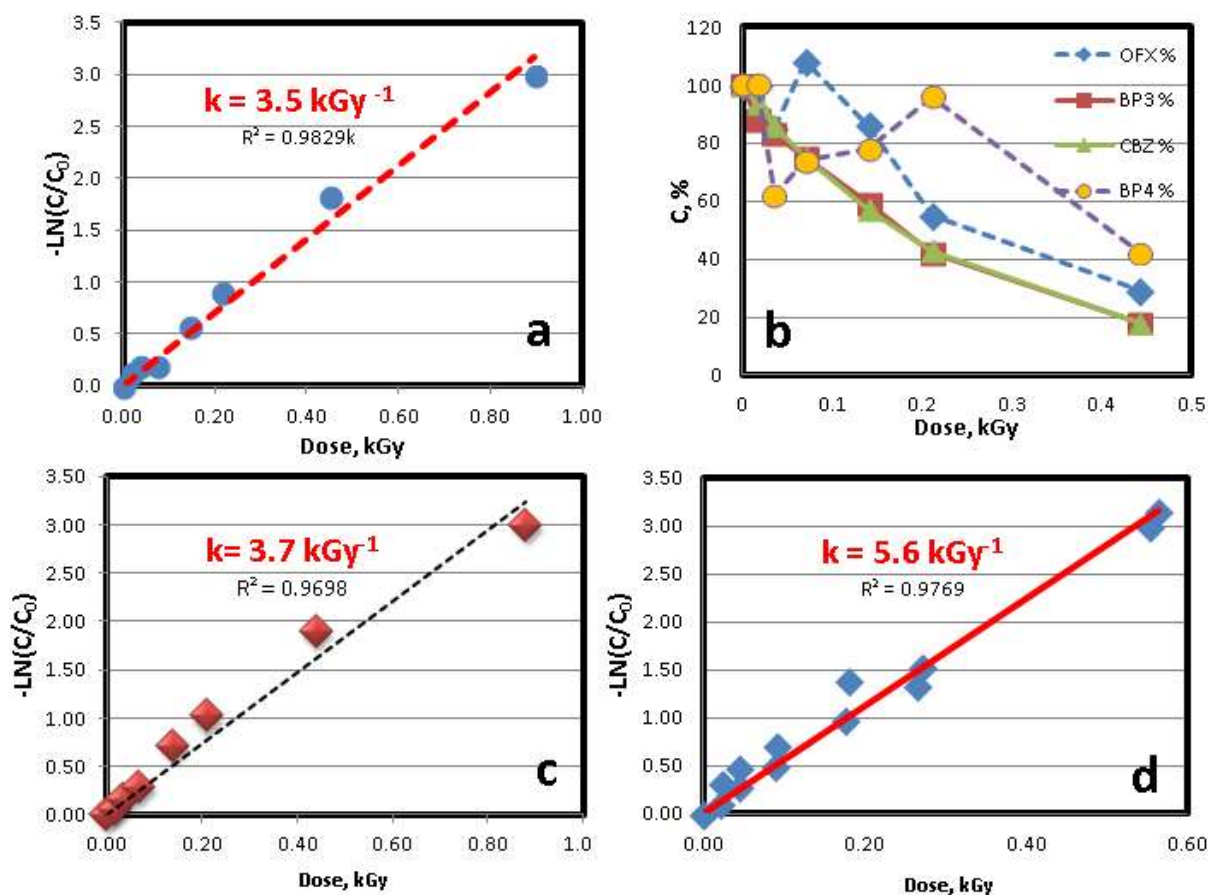

FIG. 1. γ -rays decomposition of a) OFX ($57 \mu\text{mol L}^{-1}$); b) MIX4 ($C_0 = 72 \mu\text{mol L}^{-1}$); c) OFX with H_2O_2 ; d) MIX4 with H_2O_2 . C is the total molarity of MIX4 that is the sum of the concentrations of the four EOCs.

The overall decomposition rate of OFX (Figs. 1a and 1c) follows a first order kinetics vs. the dose. It is also independent of the concentration of $\cdot\text{OH}$. In fact, in the presence of H_2O_2 (Fig. 1c) the concentration of $\cdot\text{OH}$ was doubled by capturing e_{aq}^- ($e_{\text{aq}}^- + \text{H}_2\text{O}_2 \rightarrow \cdot\text{OH} + \text{OH}^-$). As the rate constant is practically the same ($k_{\text{natural}} = 3.5$ and $k_{\text{H}_2\text{O}_2} = 3.7 \text{ kGy}^{-1}$), the process depends only on the concentration of OFX. Comparison is allowed as OFX is consumed almost uniquely by $\cdot\text{OH}$ in both systems: the reaction of e_{aq}^- with OFX in fact is ruled out by the occurrence of reaction 1 and 2. During the degradation of MIX4, anomalous data are found for the oxidation/reduction system (Fig. 1b) probably because the interaction between OFX and BP4.

Treating MIX4 as a single molecule, that is considering the kinetics of the total molarity (the sum of molarities of each EOC), the kinetics also follow the first order. Furthermore, in terms of dose, MIX5 is consumed about 50% faster than OFX alone. It is to be remarked that, in the present case, the four molecules react with $\cdot\text{OH}$ at similar rates (near diffusional rates).

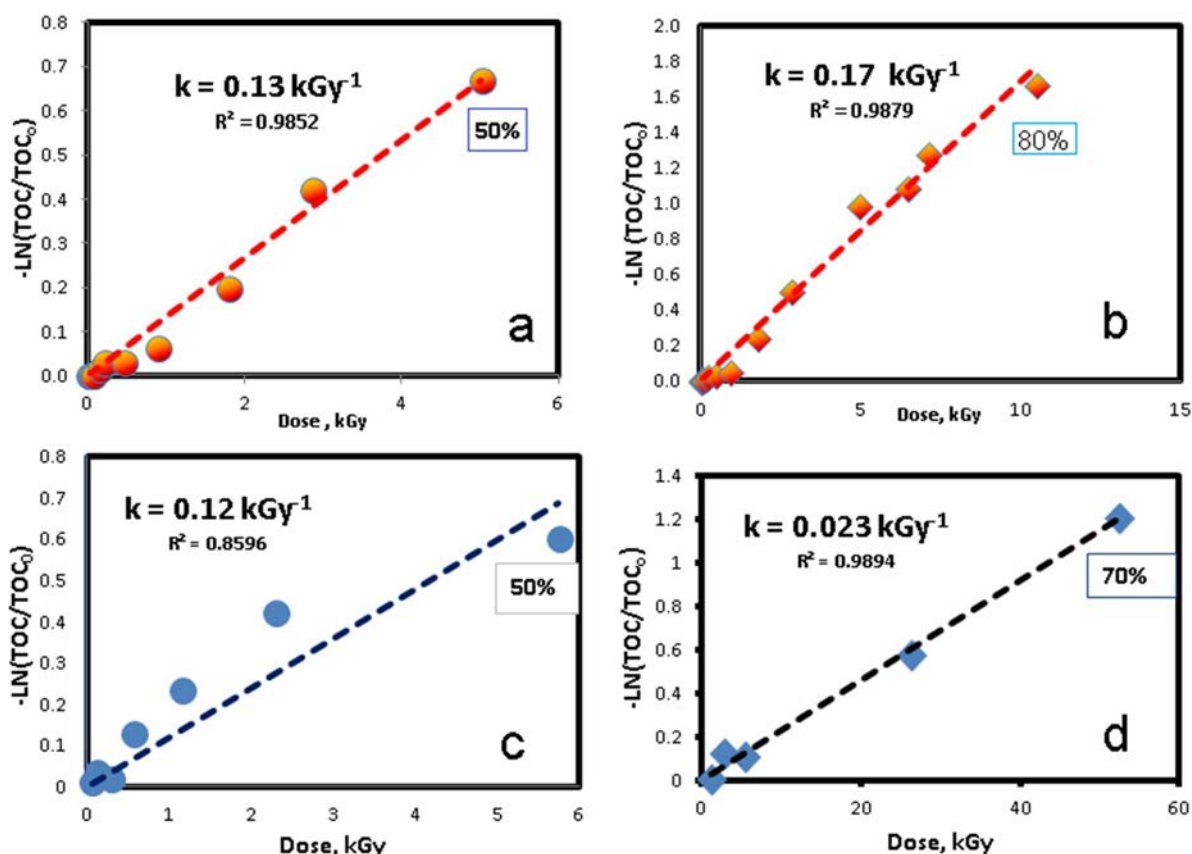

FIG. 2. Mineralization of: a) OFX and b) MIX4 (5 mg L⁻¹ each EOC) with γ -rays and air; c) OFX and d) MIX4 with EB and air.

The mineralization of OFX in γ (Fig. 2a), evaluated as the TOC decrease vs. dose, obeys to a first order dependence on dose, k_{miner} results about 0.1 kGy⁻¹ at least until a 50% reduction value. Data below 3 mg L⁻¹ are ignored as this value corresponds to the limit of detection of our method. It is worth to remark that the mineralization rate per dose unit is approximately 1/35 the decomposition rate of OFX (Fig. 1). In other words, until linearity is respected, the mineralization requires 35 times the dose required for decomposing the contaminant (you can verify with a couple of 50% decomposition/mineralization data: dose is 0.14 for OFX and 5.0 kGy for mineralization).

The mineralization rate of the complex system follows a linear behaviour vs. dose as well as the OFX alone, until the 70 – 80% TOC removal. Also, under gamma treatment the rate constant is very similar, 0.17 kGy⁻¹. The EB treatment, instead, shows a loss of 86% efficiency vs. gamma; the rate constant, in fact, drops down to 0.023 kGy⁻¹. Then, we may provisionally argue that the change of dose rate from gamma to EB (7 order of magnitude) has a negligible effect on the mineralization rate of a single contaminant, while is remarkable in a complex system.

By approaching mineralization (50 – 80%), we found that the treatments above, either with or without H₂O₂, led to a substantial increase of acidity in both solutions of OFX and MIX4, i.e. pH changed from around neutrality to level down at around 4. As a tendency to neutrality was expected by approaching mineralization, we advanced the hypothesis that N and F inorganic acids are formed even if a previous work [33] report that the defluorination of

fluoroquinolones is not the first degradation step. However, a full explanation for the high acidity of the treated solutions is yet to be found.

3.3. Ultrasound-UV-TiO₂ and hybrid techniques

In 2007, Kidak *et al.* [34] demonstrated that the combination of UV, a catalyst and ultrasounds rendered considerable degrees of decay. In 2014, Rahmani *et al.* [35] proved 80% tinidazole removal within 150 minutes from aqueous solution by sonolysis in the presence of 333 mmol L⁻¹ of H₂O₂. Herein, we report on the synergetic effect of ultrasounds and UV-TiO₂ with the apparatus shown in Fig. 3.

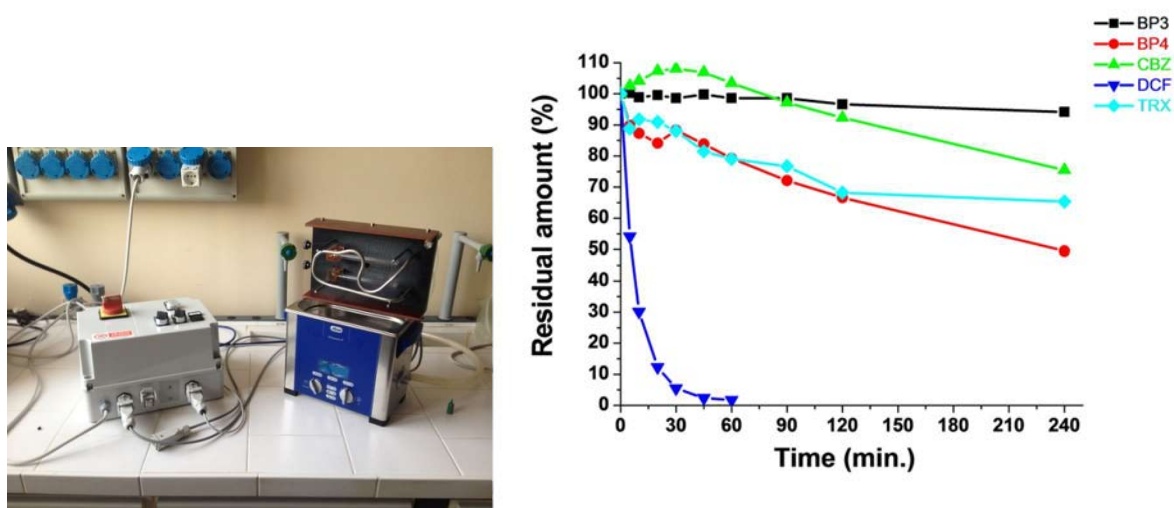

FIG. 3. Apparatus for the ultrasound-UV-TiO₂ hybrid technique and diagram of UV (9 W) treatment with ultrasounds (37 kHz 30 W) of contaminated water (1 L).

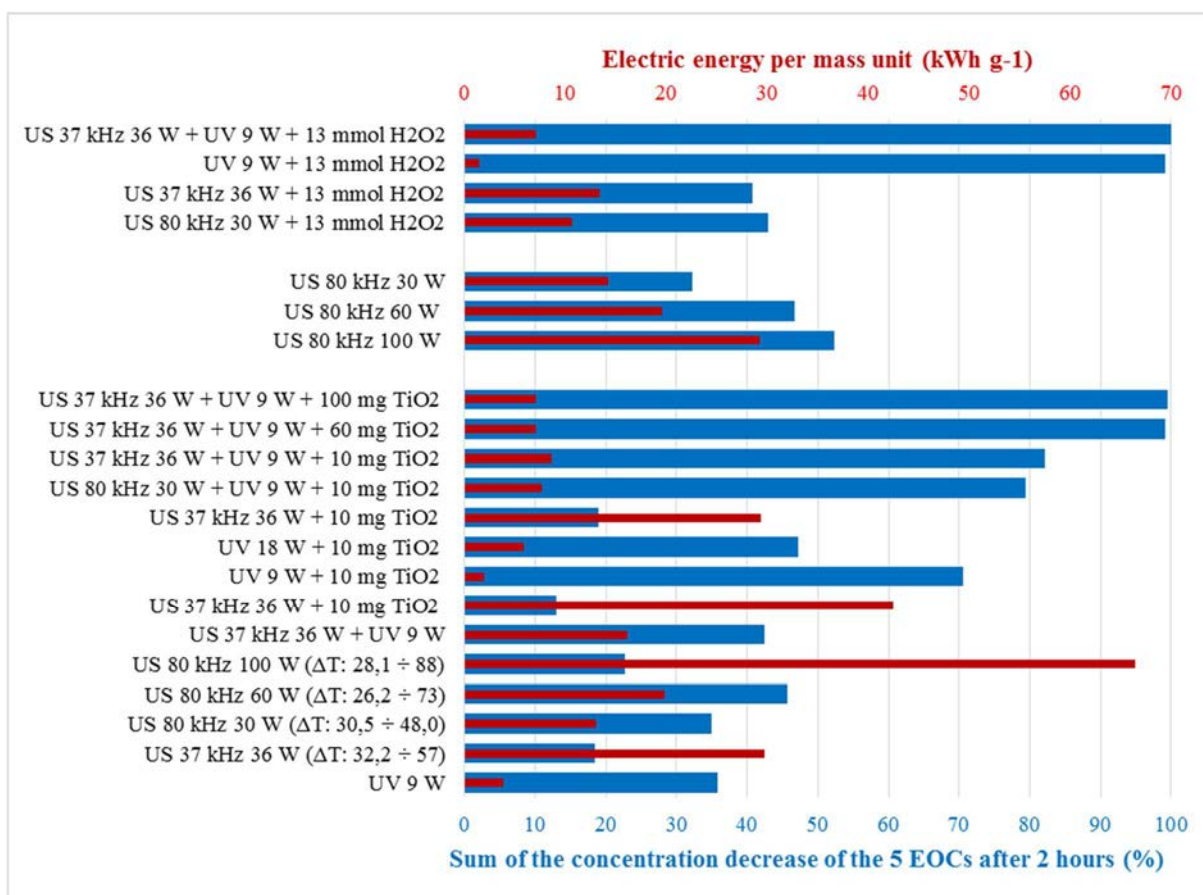

FIG. 4. Relative decrease of the total concentration of five EOCs (blu), and electric energy per degraded mass (red), under many conditions involving ultrasounds (US), UV and TiO₂.

The degradation rate of the contaminants during the hybrid treatments was faster than by using ultrasounds or UV irradiation alone. Fig. 3 (right) reports the results of the coupled technique. However, an investigation on the electric energy consumed per gram of contamination removed (E_{EM}) [37] reveals the drawback of the ultrasounds. Fig. 4 shows a summary of the EOC decrease, and the E_{EM} , after 2 hours of treatment under 21 different conditions. The ultrasounds-UV-H₂O₂ hybrid system reaches the highest degradation degree and the UV-H₂O₂ the lower E_{EM} but does not take into account the equivalent energy spent for H₂O₂ supply. Assuming that the life of TiO₂ tends to the infinity, the faster process without reagent consumption results ultrasounds-UV-TiO₂ 60 mg L⁻¹ (more concentrated suspensions are not possible with our ultrasound apparatus and their absorbance will allow too short UV penetration) but the lowest E_{EM} is obtained with the UV-TiO₂ 10 mg L⁻¹ (more concentrated suspensions are not possible without ultrasounds).

3.4. Scale-up of UV-TiO₂

Most of the photo-catalytic applications are carried out by using suspended systems [38, 39] but these processes require an additional treatment in order to separate the catalyst from the treated aqueous suspension [40]. The scale-up of photo-catalytic processes need the immobilization of the photo-catalyst on suitable solid matrices for the catalyst recovery and reuse. For example, a TiO₂ immobilized on fibreglass cloth by sol-gel method after 6 hours of UV irradiation allowed the partial mineralization of a 0.1 mmol L⁻¹ aqueous solution of nonylphenol polyetoxylate, a surfactant very close to TRX.

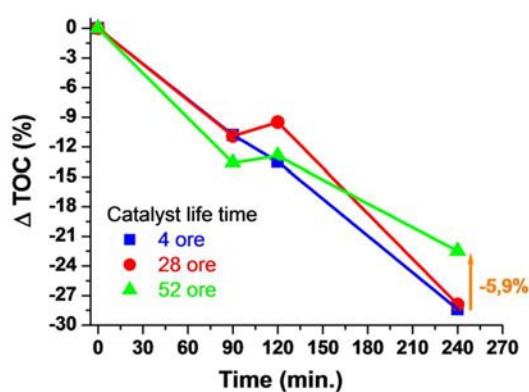
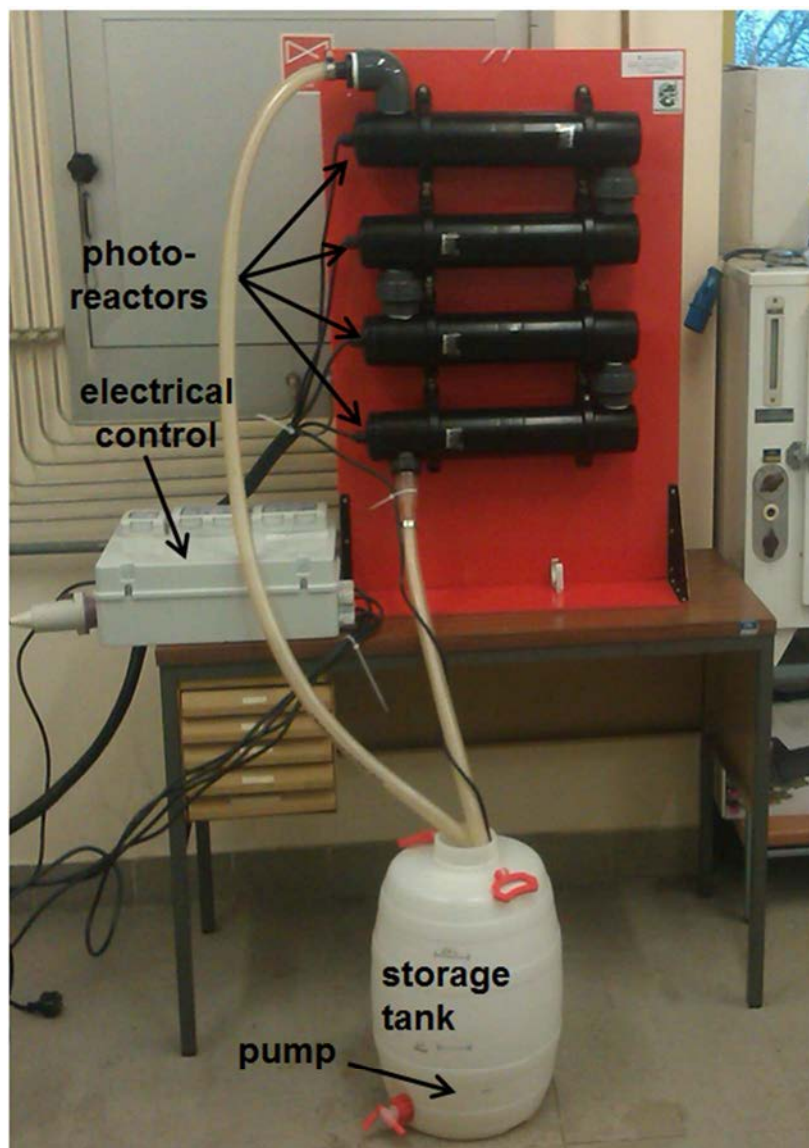

FIG. 5. Photo-catalytic large-size reactor 10÷25 L and TOC variation during the repeated treatment of OFX with UV, air and TiO₂ on the inner cylinder surface.

A new large-size photo-reactor consisting of four UV lamps (~254 nm, 36 W each), a tank (10÷25 L), and a recycling pump (0.36 m³ h⁻¹) has been developed in our laboratory (Fig. 5 left). The immobilization of TiO₂ on the solid surfaces was carried out by PURETi Italia s.r.l.,

using the PURETi Clean® photo-catalytic system consisting of a TiO₂ aqueous solution. Two different substrates covered with the TiO₂ PURETi photo-catalyst were tested. In the first case, TiO₂ was applied on the inner layer of the tubes including the UV lamps, in the second case it was spread on four (20 × 36) cm² nets of fiberglass covered with plastic material, inserted around the UV lamps. Each net had 42 holes in 1 cm², 3 mm thickness and an average absorbance of 0.15 (standard deviation 0.04). The load average load of PURETi Clean® was about 0.1 mg cm². 10 L of deionized water containing 25 mg L⁻¹ of OFX has been treated in the large-size reactor with and without the catalyst and with and without air bubbling in the storage tank. The O₂ saturation slightly increases with the air bubbling indicating that the recycling maintains a satisfactory air exchange.

The concentration of OFX was determined by recording a calibration line in the range 0 – 0.035 mmol L⁻¹ (correlation coefficient 0.99999) at the maximum of the absorption band (290 nm). The molar extinction coefficient resulted 27000 L mol⁻¹ cm⁻¹. In the literature are reported a couple of molar extinction coefficients having a wide dispersion: 20500 L mol⁻¹ cm⁻¹ in water at pH 7 [41], and 20000–25000 L mol⁻¹ cm⁻¹ in a phosphate buffer solution 5×10⁻³ mol L⁻¹ at pH 7.4 [33].

TABLE 1. VARIATION OF OFX CONCENTRATION DURING THE DIFFERENT DEGRADATION TREATMENTS

Time (min.)	UV	UV + air	UV + TiO ₂	UV+air+TiO ₂
10	-8.9	-8.7	-8.5	-16.3
20	-13.3	-15.2	-19.1	-19.2
40	-26.7	-30.4	-25.5	-42.9
60	-40.0	-41.3	-46.6	-57.1
90	-57.8	-56.5	-68.1	-71.4
120	-66.7	-71.7	-79.6	-81.2
240	-88.9	-87.0	-93.6	-93.3

As expected from the data on the O₂ saturation, the concentration of OFX was determined by recording a calibration line in the range 0 – 0.035 mmol L⁻¹ (correlation coefficient 0.99999) at the maximum of the absorption band (290 nm). The molar extinction coefficient resulted 27000 L mol⁻¹ cm⁻¹. In the literature are reported a couple of molar extinction coefficients having a wide dispersion: 20500 L mol⁻¹ cm⁻¹ in water at pH 7 [41], and 20000–25000 L mol⁻¹ cm⁻¹ in a phosphate buffer solution 5×10⁻³ mol L⁻¹ at pH 7.4 [33].

Table 2 shows that the presence of air bubbling in the storage tank does not influence the OFX degradation. The addition of the TiO₂ on the planar surface, enhance the degradation rate without significant variation on pH that remains around 6.5. The decrease of 93% of the OFX concentration corresponds to a TOC decrease of the 28% (Fig. 5 right). This modest result is related to the poor transparency of the OFX solution to the UV radiation and to the relatively optical distance from the catalyst (15 – 18 mm) to the light source. After 52 hours of work, the catalyst loses about 5% of its capacity to mineralize the OFX showing a promising life-time.

Three sequences of treatments were carried out: the first one by using UV alone represented the benchmark test; the second one was performed using only the tubes with TiO₂ immobilized on their inner surface (Table 3, columns A); and the third one both with the tubes and the nets (Table 3, columns B). In all these experiments DCF completely disappears due to its photo-lability. After 4 hours of treatment with UV radiation without photo-catalyst the degradation of the other EOCs was satisfactory: -45% for BP3, -60% for CBZ, -65% for

TRX and -85% for BP4. The addition of the TiO₂ on the cylinders (Table 2) enhances the degradation of BP4 and TRX but decreases that of CBZ. The addition of the nets coated by the TiO₂ close to the UV sources, enhances the degradation rate reaching the complete disappearance of TRX, the degradation of BP3, BP4 and CBZ to -78%, -90% and -84%, respectively. Furthermore, the TOC decrease, that in the previous treatments was unsatisfactory, reached the -28% after 4 hours and by -38% after 6 hours.

TABLE 2. CONCENTRATION DECREASE OF THE FIVE EOCs IN MIX5 TREATED IN THE LARGE-SIZE REACTOR WITH TiO₂: A) ON THE CYLINDERS; B) ON THE CYLINDERS AND ON THE NETS

Time (min)	BP3		BP4		CBZ		DCF		TRX	
	A	B	A	B	A	B	A	B	A	B
5	-3.7	-1.4	-12.1	-17.9	10	4	-86.9	-82.3	-1.5	-4.7
10	-6.7	-3.2	-13.1	-34.2	2.4	2.3	-100	-89.3	-10.4	-11.4
20	-10	-5.7	-43.1	-50.1	0	-3.4	-100	-95.5	-6.4	-21.8
30	-10.1	-7.7	-57.6	-58	-2.3	-8.2	-100	-97	-16.2	-28.4
45	15.7	13.2	-66.5	-67.5	-6.8	-14.8	-100	-100	-19.9	-44.9
60	-4.4	-18	-76.2	-74.5	-9.9	-21.7	-100	-100	-39.4	-52
90	-22.5	-29.3	80.3	-82.3	-14.4	-35.9	-100	-100	-33.8	-79.9
120	-27.5	-41.1	-83.6	-85.1	-21.4	-48.4	-100	-100	-41	-85.7
240	-44.7	-78	-88.5	-90.4	-47.8	-83.6	-100	-100	-87.9	-100

4. SUMMARY

As a general conclusion on ionizing radiations, at low dose rates (γ) almost equal decomposition rate of the single contaminant (OFX) have been found. The same occurred for the multi-component system on its side. Also, a cross comparison between the single molecule and MIX4 seems to indicate that the mixture is decomposed a little faster. The mineralization rate of the single molecule (OFX) is equally unaffected by varying the dose rate of 7 order of magnitude ($\gamma \rightarrow$ EB). Instead the mineralization rate of the mixture by EB suffers of an 86% loss of efficiency with respect to γ -treatment. Finally, remediation technologies would benefit from comparing bench data of both decomposition and mineralization of complex systems with those of their isolated components. This will improve the ability to predict time and energy expenditure for remediation of real wastewater. The collection of experimental data on the relationship of decomposition/mineralization rates, are desirable for the modelling of plants and the prediction of the energy consumption.

Ultrasound cavitation results to be the least developed AOP, however, ultrasounds can be coupled to other AOPs in hybrid techniques to speed up the reactions but a careful energetic analysis is needed. Ultrasounds are an efficient way to suspend catalysts in floating bed reactors, and to enhance the reaction rate when the kinetics is under mass transport limitation.

The large-scale photo-catalytic reactor decreased EOC concentration down to 40% when equipped with TiO₂ immobilized on the inner side of the reactor but the mineralization degree was poor. The efficiency of MIX5 degradation can be significantly improved by adding nets coated by TiO₂ close to the UV source. Nevertheless, the degradation degree reaches the 38% in 6 hours. The improvement of the photo-catalyst and of its geometry is expected to enhance the large-size reactor performance.

REFERENCES

- [1] SARACINO, M., EMMI, S.S., ZANELLI, A., "Water remediation 2.0: Advanced oxidation processes"; *La Chimica e l'Industria*, (2015) in press.
- [2] ZANELLI, A.; SARACINO, M.; PRETALI, L.; NAVACCHIA, M.L.; ESPOSITO, B.; CIARLETTA, A.; CAPOBIANCO, M.L.; EMMI, S.S., "Aops degradation of mixtures of emerging organic pollutants performed in deionized-, tap-, and domestic laundry wastewater", IAEA Report, Budapest, 2014.
- [3] BALMER, M.E., BUSER, H.R., MULLER, M.D., POIGER, T., "Occurrence of some organic uv filters in wastewater, in surface waters, and in fish from swiss lakes"; *Environ. Sci. Technol.* **39** (2005) 953.
- [4] RODIL, R., BENITO QUINTANA, J., CONCHA-GRANA, E., LOPEZ-MAHIA, P., MUNIATEGUI-LORENZO, S., PRADA-RODRIGUEZ, D., "Emerging pollutants in sewage, surface and drinking water in galicia (nw spain)"; *Chemosphere*, **86** (2012) 1040.
- [5] KAISER, D., WAPPELHORST, O., OETKEN, M., OEHLMANN, J., "Occurrence of widely used organic uv filters in lake and river sediments"; *Environ. Chem.* **9** (2012) 139.
- [6] LIU, Y.-S., YING, G.-G., SHAREEF, A., KOOKANA, R.S., "Photostability of the uv filter benzophenone-3 and its effect on the photodegradation of benzotriazole in water"; *Environ. Chem.* **8** (2011) 581.
- [7] MEFFE, R., DE BUSTAMANTE, I., "Emerging organic contaminants in surface water and groundwater: A first overview of the situation in italy"; *Sci. Total Environ.* **481** (2014) 280.
- [8] ZHANG, Y.J., GEISSEN, S.U., GAL, C., "Carbamazepine and diclofenac: Removal in wastewater treatment plants and occurrence in water bodies"; *Chemosphere*, **73** (2008) 1151.
- [9] LESTER, Y., MAMANE, H., ZUCKER, I., AVISAR, D., "Treating wastewater from a pharmaceutical formulation facility by biological process and ozone"; *Water Res.* **47** (2013) 4349.
- [10] VIENO, N., SILLANPAA, M., "Fate of diclofenac in municipal wastewater treatment plant - a review"; *Environ. Int.* **69** (2014) 28.
- [11] RATOLA, N., CINCINELLI, A., ALVES, A., KATSOYIANNIS, A., "Occurrence of organic microcontaminants in the wastewater treatment process. A mini review"; *J. Hazard. Mater.* **239** (2012) 1
- [12] POIGER, T., BUSER, H.R., MULLER, M.D., "Photodegradation of the pharmaceutical drug diclofenac in a lake: Pathway, field measurements, and mathematical modeling"; *Environ. Toxicol. Chem.* **20** (2001) 256.
- [13] LA FARRE, M., PEREZ, S., KANTIANI, L., BARCELO, D., "Fate and toxicity of emerging pollutants, their metabolites and transformation products in the aquatic environment"; *Trac-Trend Anal. Chem.* **27** (2008) 991.
- [14] ABU-GHUNMI, L., BADAWI, M., FAYYAD, M., "Fate of triton x-100 applications on water and soil environments: A review"; *J. Surfactants Deterg.*, **17** (2014) 833.
- [15] CZECH, B., CWIKLA-BUNDYRA, W., "Advanced oxidation processes in triton x-100 and wash-up liquid removal from wastewater using modified TiO₂/Al₂O₃ photocatalysts"; *Water Air Soil. Poll.* **223** (2012) 4813.
- [16] EMMI, S.S., CAMINATI, S., CAPOBIANCO, M.L., CASTRO, C., ESPOSITO, B., FERRI, E., MARTELLI, A., NAVACCHIA, M.L., PRETALI, L., SARACINO, M., SCONZIANO, S., ZANELLI, A., "Comparative results between ionizing and non-ionizing radiation technologies for wastewater remediation", in *TEC.DOC.*, in press, IAEA, Vienna, (2013)
- [17] STURINI, M., SPELTINI, A., MARASCHI, F., PROFUMO, A., PRETALI, L., FASANI, E., ALBINI, A., "Photochemical degradation of marbofloxacin and enrofloxacin in natural waters"; *Environ. Sci. Techno.* **44** (2010) 4564.
- [18] VIENO, N., TUHKANEN, T., KRONBERG, L., "Elimination of pharmaceuticals in sewage treatment plants in finland"; *Water Res.* **41** (2007) 1001.

- [19] MOHAPATRA, D.P., BRAR, S.K., TYAGI, R.D., PICARD, P., SURAMPALLI, R.Y., "Analysis and advanced oxidation treatment of a persistent pharmaceutical compound in wastewater and wastewater sludge-carbamazepine"; *Sci. Total Environ.* **58** (2014) 470–471 .
- [20] RODRIGUEZ, E.M., MARQUEZ, G., LEON, E.A., ALVAREZ, P.M., AMAT, A.M., BELTRAN, F.J., "Mechanism considerations for photocatalytic oxidation, ozonation and photocatalytic ozonation of some pharmaceutical compounds in water"; *J. Environ. Manag.* **127** (2013) 114.
- [21] PI, Y., FENG, J., SUN, J., SONG, M., SUN, J., "Oxidation of ofloxacin by oxone/co²⁺: Identification of reaction products and pathways"; *Environ. Sci. Pollut. Res.* **21** (2014) 3031.
- [22] MICHAEL, I., HAPESHI, E., ACENA, J., PEREZ, S., PETROVIC, M., ZAPATA, A., BARCELO, D., MALATO, S., FATTA-KASSINOS, D., "Light-induced catalytic transformation of ofloxacin by solar fenton in various water matrices at a pilot plant: Mineralization and characterization of major intermediate products"; *Sci. Total Environ.* **461** (2013) 39.
- [23] MICHAEL, I., HAPESHI, E., MICHAEL, C., VARELA, A.R., KYRIAKOU, S., MANAIA, C.M., FATTA-KASSINOS, D., "Solar photo-fenton process on the abatement of antibiotics at a pilot scale: Degradation kinetics, ecotoxicity and phytotoxicity assessment and removal of antibiotic resistant enterococci"; *Water Res.* **46** (2012) 5621.
- [24] DENG, J., SHAO, Y., GAO, N., XIA, S., TAN, C., ZHOU, S., HU, X., "Degradation of the antiepileptic drug carbamazepine upon different uv-based advanced oxidation processes in water"; *Chem. Eng. J.*, **222** (2013) 150.
- [25] DAI, C.-M., ZHOU, X.-F., ZHANG, Y.-L., DUAN, Y.-P., QIANG, Z.-M., ZHANG, T.C., "Comparative study of the degradation of carbamazepine in water b`y advanced oxidation processes"; *Environ. Technol.* **33** (2012) 1101. `
- [26] YANG, B., YING, G.-G., "Oxidation of benzophenone-3 during water treatment with ferrate(vi)"; *Water Res.* **47** (2013) 2458.
- [27] RODIL, R., MOEDER, M., ALTENBURGER, R., SCHMITT-JANSEN, M., "Photostability and phytotoxicity of selected sunscreen agents and their degradation mixtures in water"; *Anal Bioanal. Chem.* **395** (2009) 1513.
- [28] DE LAURENTIIS, E., MINELLA, M., SARAKHA, M., MARRESE, A., MINERO, C., MAILHOT, G.; BRIGANTE, M.; VIONE, D., "Photochemical processes involving the uv absorber benzophenone-4 (2-hydroxy-4-methoxybenzophenone-5-sulphonic acid) in aqueous solution: Reaction pathways and implications for surface waters"; *Water Res.* **47** (2013) 5943.
- [29] VIONE, D., CARINGELLA, R., DE LAURENTIIS, E., PAZZI, M., MINERO, C., "Phototransformation of the sunlight filter benzophenone-3 (2-hydroxy-4-methoxybenzophenone) under conditions relevant to surface waters"; *Sci. Total Environ.* **463** (2013) 243.
- [30] LIU, Y.-S., YING, G.-G., SHAREEF, A., KOOKANA, R.S., "Biodegradation of the ultraviolet filter benzophenone-3 under different redox conditions"; *Environ. Toxicol. Chem.* **31** (2012) 289.
- [31] AGO-FERRERO, P., DEMEESTERE, K., SILVIA DIAZ-CRUZ, M., BARCELO, D., "Ozonation and peroxone oxidation of benzophenone-3 in water: Effect of operational parameters and identification of intermediate products"; *Sci. Total Environ.* **443**(2013) 209.
- [32] BUXTON, G.V., GREENSTOCK, C.L., HELMAN, W.P., ROSS, A.B., "Critical-review of rate constants for reactions of hydrated electrons, hydrogen-atoms and hydroxyl radicals ([•]OH/[•]O) in aqueous-solution"; *J. Phys. Chem. Ref. Data*, **17** (1988) 513.
- [33] ALBINI, A., MONTI, S., "Photophysics and photochemistry of fluoroquinolones"; *Chem. Soc. Rev.* **32** (2003) 238.
- [34] KIDAK, R., INCE, N.H., "Catalysis of advanced oxidation reactions by ultrasound: A case study with phenol"; *J. Hazard. Mater.* **146** (2007) 630.

- [35] RAHMANI, H., GHOLAMI, M., MAHVI, A.H., ALIMOHAMMADI, M., AZARIAN, G., ESRAFILI, A., RAHMANI, K., FARZADKIA, M., "Tinidazole removal from aqueous solution by sonolysis in the presence of hydrogen peroxide"; *Bull. Environ. Contam. Toxicol.* **92** (2014) 341
- [37] BOLTON, J.R., BIRCHER, K.G., TUMAS W., TOLMAN, C.A., "Figures-of-merit for the technical development and application of advanced oxidation technologies for both electric- and solar-driven systems"; *Pure Appl. Chem.* **73** (2001) 627.
- [38] ENG, Y.Y., SHARMA, V.K., RAY, A.K., "Photocatalytic degradation of nonionic surfactant, brij 35 in aqueous tio₂ suspensions"; *Chemosphere*, **79** (2010) 205.
- [39] SAIEN, J., OJAGHLOO, Z., SOLEYMANI, A.R., RASOULIFARD, M.H., "Homogeneous and heterogeneous aops for rapid degradation of triton x-100 in aqueous media via uv light, nano titania hydrogen peroxide and potassium persulfate"; *Chem. Eng. J.* **167** (2011) 172.
- [40] KLAVARIOTI, M., MANTZAVINOS, D., KASSINOS, D., "Removal of residual pharmaceuticals from aqueous systems by advanced oxidation processes"; *Environ. Int.* **35** (2009) 402.
- [41] NAVARATNAM, S., CLARIDGE, J"Primary photophysical properties of ofloxacin"; *Photochem. Photobiol.* **72** (2000) 283.

TREATMENT OF PHARMACEUTICALS/ANTIBIOTICS IN WASTEWATER BY COMBINATION OF ZEOLITE ADSORBENT WITH IONIZING RADIATION

M. TAGUCHI, Y. KUMAGAI, A. KIMURA

Japan Atomic Energy Agency

Japan

Abstract

The technology for the decomposition of trace amounts of halogenated pharmaceuticals/antibiotics was developed in wastewater by use of the combination method of zeolite adsorbent and ionizing radiation. Toxicity test was conducted using a luminescence bacterium on the irradiation of aqueous solution of 2-chlorophenol (2-CIPh) as a simple model of halogenated pharmaceuticals/antibiotics. Toxicity of 2-CIPh solution increased with the increase in γ -ray dose. The toxicity after γ -ray irradiation originates only in neither 2-CIPh nor primary products, but it is thought that it is based on a synergistic effect including organic acid or aldehyde. HMOR, a hydrophobic high-silica mordenite-type zeolite, was employed to concentrate 2-CIPh on it. HMOR adsorbed above 99% of 2-CIPh from dilute aqueous solutions. The yield of Cl^- production in HMOR mixture corresponded to the aqueous solution containing 10 fold higher concentration of dissolved 2-CIPh. Clofibrate and triclosan, one of chlorinated pharmaceuticals/antibiotics, in real wastewater were treated by use of the combination method of HMOR and ionizing radiation. Production yield of Cl^- by use of the adsorbent was about twice higher than that in aqueous solution, and HMOR was contributed for effective reduction of chlorinated pharmaceuticals/antibiotics in real wastewater.

1. OBJECTIVE OF THE RESEARCH

The technology for treatment of wastewater containing trace amounts of halogenated pharmaceuticals and antibiotics was developed by use of the combination method of zeolite adsorbent and ionizing radiation. Halogenated pharmaceuticals and antibiotics in real wastewater were condensed on HMOR, a hydrophobic high-silica mordenite-type zeolite, and decomposed effectively by γ -ray irradiation. The potentiality of the combination method using zeolite is evaluated compared with the simple irradiation method.

2. INTRODUCTION

The earth is facing various problems, including destruction of the ozone layer, global warming, acid rain, loss of tropical forests and marine pollution. Water environment on the earth has also been polluted by industrial chemicals. "Silent Spring" reported the environmental pollution by insecticides such as dichlorodiphenyltrichloroethanes (DDTs) [1]. This book made most of people to have an idea of the environmental conservation, and has been regarded as a bible on the field of environmental science and technology. Most of toxic industrial chemicals such as PCBs, dioxins, endocrine disrupters and so on have been detected during these five decades [2-4]. Some pharmaceuticals and antibiotics also have been found to give ill effects on human and aquatic animals because of their chronic and reproduction toxicities [5]. The environmental movement and risk evaluation of these pharmaceuticals and personal care products are studied, and the concentrations of the pharmaceuticals in the water environment increased gradually because of the population growth and the diversification of advanced medical worldwide [6-8].

Ionizing radiations have a potential to be applied in the decomposition of pollutants in wastewater [9-13]. The energy deposition by ionizing radiations is high enough to break the chemical bonds of materials. Therefore, the irradiation can degrade the pollutants in waters. The schemes of radiation-induced reactions are, however, complicated in most cases due to the high reactivity and low reaction selectivity of radicals. The complicated reaction scheme induces many intermediate by-products. Therefore, when radiation treatment is going to be applied to an actual pollutant, the toxicity due to the by-products should be evaluated [14-17]. In addition, another problem due to the complicated reaction schemes is reduction of the degradation efficiency of target pollutants, especially for dilute pollutants. An improvement on the reaction efficiency is necessary for the irradiation treatment to expand its potential application in the field of environmental technology.

Hence, we have examined two concepts using 2-CIPh as a simple model compound, aiming to address the difficulties due to the complicated reaction scheme. One is the applicability of a biological toxicity assay to the irradiation treatment. The evaluation of biological toxicity, in addition to the chemical analysis, will provide useful knowledge for designing a practical degradation process using ionizing radiations. In order to discuss the applicability of biological assay, we carried out a toxicity test using a luminescence bacterium [18] on the irradiation of aqueous solution of 2-CIPh. The other concept is combined usage of solid-phase extraction to improve the reaction efficiency of the irradiation treatment. By concentrating a target compound on a solid adsorbent, the reaction efficiency is expected to be improved [19]. We focused on zeolite minerals because zeolites have excellent radiation resistances [20] and potential capacities of adsorbing organic compounds [21]. We investigated the effect of zeolites on the radiation-induced degradation of 2-CIPh in aqueous solution. Moreover we applied this zeolite-combined method to a chlorinated pharmaceutical, clofibrate, and an antibiotic, triclosan. As the first trial, clofibrate and triclosan were selected because these compounds, which have similar chemical structures to 2-CIPh, were reported to be consumed and released a lot worldwide [4]. Trace amounts of these compounds were removed from real wastewater using a zeolite adsorbent, and then decomposed by γ -ray irradiations.

3. MATERIALS AND METHODS

Aqueous solutions for irradiation experiments were prepared by dissolving 2-CIPh (98%, Wako), triclosan (99.5%, Wako) or chlofibrate (99%, Aldrich) in pure water or real wastewater. The pure water was supplied from Milli-pore Mill-Q systems (resistivity $1.82 \times 10^7 \Omega \cdot \text{cm}$). The wastewater was sampled at effluent from Japan Atomic Energy Agency. The pH value of the wastewater was 7.45 and the amount of TOC was measured to be about 10 to 60 mgC dm⁻³. The pH and TOC values were measured by pH meter (MP220, METER TOLEDO) and TOC analyzer (VWP-T, Shimadzu).

The zeolites used in this study were A-type (NaA), X-type (NaX), mordenite-type (NaMOR) and high-silica mordenite-type (HMOR) in powder form. NaA (A-4, powder <75 μm , TOSO), NaX (F-9, powder <75 μm , TOSO) and NaMOR (HS-642, powder 12 μm mean particle size, Wako) contains sodium as charge-balancing cation, and HMOR (HS-690, powder 13 μm mean particle size, Wako) contains hydrogen. The SiO₂/AlO₂ ratios of NaA, NaX, NaMOR and HMOR were 2.0, 2.5, 18, and 240, respectively. Boric acid (H₃BO₃, 99.5%, Wako), sodium hydroxide (NaOH, 50wt% solution, Wako) and sodium sulphate (Na₂SO₄, 99.5%, Wako) was used for pre-treatments of the zeolites. The zeolites were washed with aqueous solution of H₃BO₃ and NaOH (pH 9) or aqueous solution of H₃BO₃ and Na₂SO₄ (pH 6) to remove redundant acid or base contents in the as-received zeolites. The washed zeolites were rinsed with pure water and dried at 400 °C for 8 hours to remove possible

organic impurities. The dried zeolites were then exposed to water vapour in a closed container, because weighing the dried zeolites was difficult due to the adsorption of water molecules from air. The relative humidity in the container was maintained at $74 \pm 3\%$ with saturated sodium nitrate solution at room temperature 22 ± 3 °C. The pre-treated zeolites were mixed with the aqueous solutions. Na_2SO_4 was added to the aqueous solution when mixed with the zeolites in order to adjust the sodium concentration (Na^+ , $1 \times 10^{-3} \text{ mol} \cdot \text{dm}^{-3}$) to the condition in the pre-treatment.

The irradiations of samples were conducted using a ^{60}Co γ -ray source at Takasaki Advanced Radiation Research Institute, Japan Atomic Energy Agency. The samples were irradiated at dose range up to $1.0 \times 10^5 \text{ Gy}$ ($\text{Gy} = \text{J} \cdot \text{kg}^{-1}$) with the dose rates from 1 to $10 \times 10^3 \text{ Gy} \cdot \text{h}^{-1}$. During the irradiation, the samples were not stirred. The samples mixed with the zeolites were shaken and homogenized after the irradiation, and then aqueous solution was separated by filtration through membrane filters for analysis. The chemical analyses of aqueous solutions were carried out by high performance liquid chromatograph (HTACHI 2000-series or Agilent 1100 series) and ion chromatograph (Shimadzu LC-10A or Dionex ICS-1000).

Toxicity of aqueous solution before and after γ -ray irradiation was evaluated from the change of the luminescence intensity of the luminescence bacteria (photobacterium phosphoreum), which received respiratory metabolism prevention with the toxic substances. MARINE BROTH 2216 medium (MB med., Difco) was dissolved in pure water at initial concentration of 3.74%. A medium (T med.) was prepared with 0.4g of peptone (Difco), 3.5g of glucose (Difco), 20g of NaCl (Difco), 29g of mgSO_4 (Difco), 0.9g of KCl (Difco), 0.1g of K_2HPO_4 (Difco), 209g of 3-morpholinopropane-1-sulfonic acid (MOPS, Dojin) dissolved in 1 dm³ of pure water. The MB med. and T med. were mixed in equal amounts of 50 m³, and then the luminescence bacteria solution (Microtox Kit, Microbics) was added 0.6 m³. 2-ClPh aqueous solutions before and after γ -ray irradiation were added by a different dilution rate to the mixed solutions of luminescence bacteria and culture medium. Luminescence from bacteria of the 2-ClPh solutions was measured using Luminescencer–JNR (ATTO, AB-2100).

4. RESULTS AND DISCUSSION

4.1. Chemical and biological analyses of γ -ray irradiated aqueous chlorophenol solution

Chlorophenol aqueous solution at initial concentration of 1 mmol dm^{-3} under air saturated condition was irradiated with ^{60}Co γ -rays to produce 3-chlorocatechol, chlorohydroquinone and phenol as shown in Fig. 1. Concentration of 2-ClPh decreased with increasing dose and reached zero at 8 kGy, and 60 percent of chlorine was released in water as chlorinated ion. Concentration of these primary products increased up to 3 kGy and then decreased.

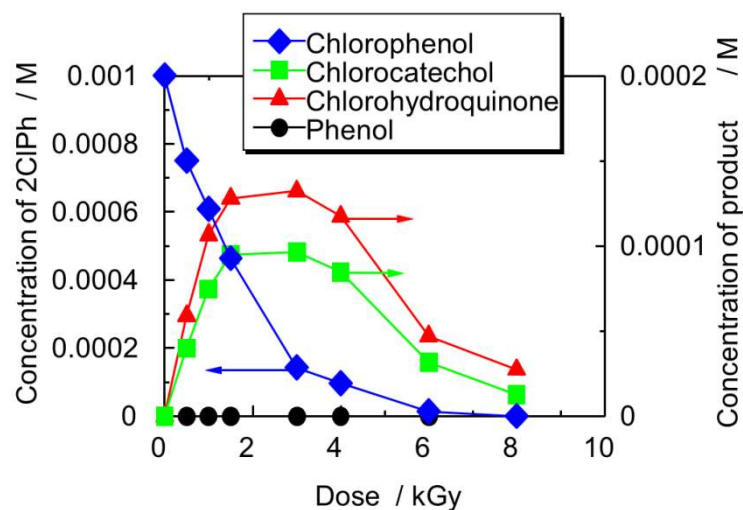

FIG. 1. γ -radiolysis of 2-ClPh aqueous solution at initial concentration of 1 mmol dm⁻³ under air saturated condition.

Toxicity of the 2-ClPh aqueous solution by γ -ray irradiation was investigated by the change of the luminescence intensity of the luminescence bacteria as shown in Fig. 2. Their toxicities increased with absorbed dose, and the irradiation products were considered to have toxicity. Under nitrogen saturated condition, formations of 3-chlorocatechol and chlorohydroquinone were significantly reduced and that of phenol slightly increased compared to oxygen-saturated condition. Increase in toxicity of 2-ClPh aqueous solution by γ -ray irradiation under nitrogen saturated condition was gently as compared to the oxygen saturated condition as shown in Fig. 2. Toxicities of the 2-Cl, chlorocatechol, chlorohydroquinone and phenol aqueous solutions were evaluated by luminescence intensity of the luminescence bacteria, respectively.

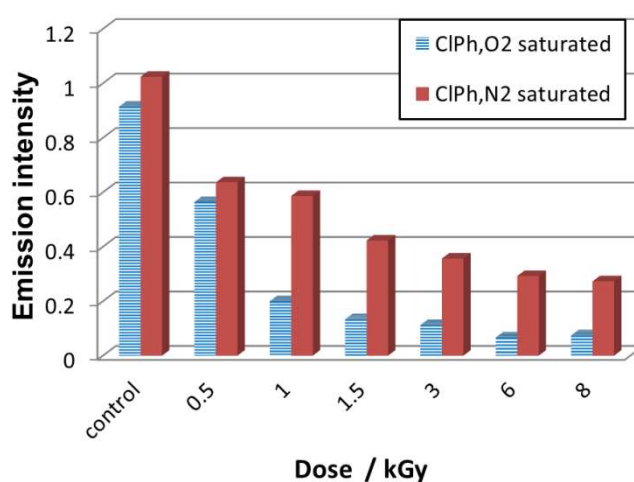

FIG. 2. Toxicity of the 2-ClPh aqueous solution by γ -ray irradiation.

The concentration of 2-ClPh required to decrease half of the luminescence bacteria (LC_{50}) was about 1 mmol dm^{-3} as shown in Fig. 3a while that of phenol was more than 1 mmol dm^{-3} . LC_{50} value of 3-chlorocatechol and chlorohydroquinone were about 0.4 and 0.1 mmol dm^{-3} (Fig. 3b), indicating that 3-chlorocatechol and chlorohydroquinone are highly toxic than chlorophenol. Toxicity was higher than the total toxicity predicted from the concentration of 2-ClPh and primary products. The toxicity after γ -ray irradiation originates only in neither 2-ClPh nor primary products, but it is thought that it is based on a synergistic effect including organic acid or aldehyde, hydrogen peroxide [13-17]. Lysine is an essential amino acid and contained in beans or fishes mostly. Increase on the toxicity of chlorophenol aqueous solution after ^{60}Co γ -ray irradiation was suppressed by the addition of lysine, considering that lysine may protect the luminescence bacteria.

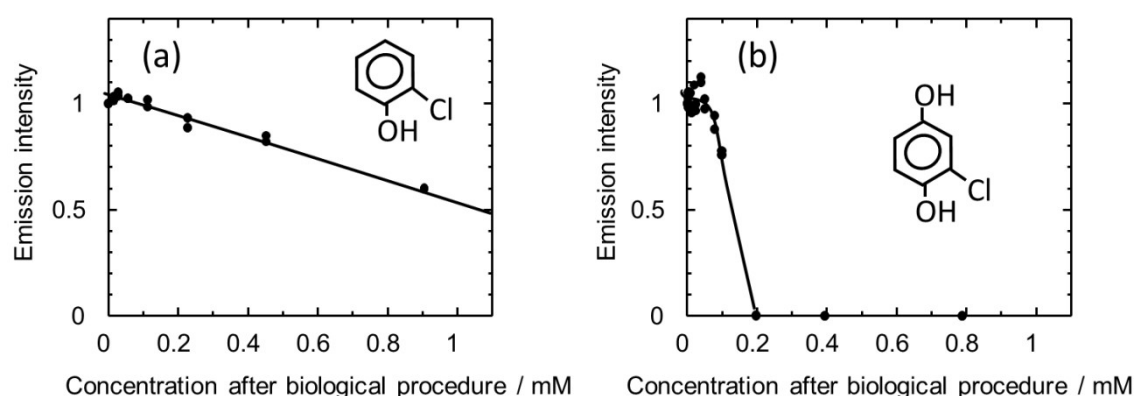

FIG. 3. Toxicities of (a) 2-ClPh and (b) chlorohydroquinone aqueous solutions.

4.2. Effect of zeolite materials on radiolytic degradation of aqueous 2-chlorophenol

4.2.1. Comparison of zeolites with different structures

As a brief screening of zeolite adsorbents, production of chloride ion (Cl^-) by irradiation was compared among the zeolites of different structures, NaA, NaX and NaMOR. In this screening, the zeolites were used as received. The zeolites and $1.0 \times 10^{-2} \text{ mol} \cdot \text{dm}^{-3}$ aqueous 2-ClPh solution were mixed at a solid/liquid ratio of 3/7, and the mixtures were irradiated. The Cl^- production was observed in all the mixture, but the production yields were different. The addition of NaA and NaX decreased the Cl^- concentration, whereas the mixture with NaMOR showed higher Cl^- concentrations than those in aqueous solution. The Cl^- production can be regarded as a quantitative indicator of the 2-ClPh degradation, because the zeolites scarcely adsorb anions from aqueous solution. The result indicates that mordenite-type zeolites have a potential to increase the degradation yield of aqueous organic compounds. Therefore, further experiments were conducted with the zeolites of mordenite-type structure.

4.2.2. Effect of pH

Effect of pH on the 2-ClPh degradation yield was examined in order to explore a preferable condition for the zeolite-combined method. The Cl^- production was compared between the

mixtures with NaMOR having pH 5.7 and 8.6. The mixtures of pH 5.7 and 8.6 were prepared from NaMOR washed with $\text{H}_3\text{BO}_3\text{-Na}_2\text{SO}_4$ solution and with $\text{H}_3\text{BO}_3\text{-NaOH}$ solution, respectively. The solid/liquid ratio of the irradiated mixtures was 4/6. The concentrations of Cl^- and 2-ClPh in the aqueous solutions separated from the mixtures are shown in Fig. 4 as a function of absorbed dose.

The 2-ClPh concentration in the aqueous solution before mixing was $1.0 \times 10^{-3} \text{ mol} \cdot \text{dm}^{-3}$. At pH 8.6 the 2-ClPh concentration in the mixture was $9.1 \times 10^{-4} \text{ mol} \cdot \text{dm}^{-3}$, whereas the 2-ClPh concentration decreased to $4.4 \times 10^{-4} \text{ mol} \cdot \text{dm}^{-3}$ at pH 5.7. The decrease in the 2-ClPh concentration was interpreted as adsorption on NaMOR, not as decomposition, because the concentration of Cl^- did not increase before irradiation. The difference in the adsorption can be attributed to the difference in the acid dissociation of 2-ClPh. The dissociation constant, pK_a , of 2-ClPh is 8.56. The result indicates that a low pH is preferable for the adsorption on NaMOR, because the anionic form would be less likely to adsorb on NaMOR. In the irradiated samples, the production of Cl^- was higher at pH 5.7 than at pH 8.6, even though the 2-ClPh concentration in solution was lower. The degradation yield of 2-ClPh in aqueous solution is expected lower at pH 5.7 than at pH 8.6 because of the low concentration. Therefore, the observed higher production of Cl^- indicates that the adsorbed 2-ClPh was decomposed on NaMOR by the irradiation. Based on this result, the zeolites treated with $\text{H}_3\text{BO}_3\text{-Na}_2\text{SO}_4$ solution were used in further experiments.

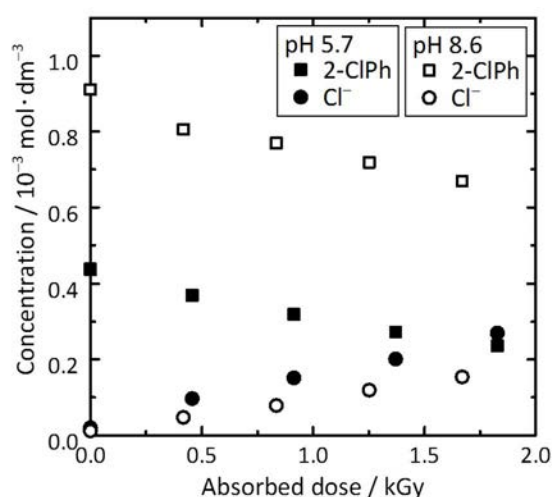

FIG. 4. Concentrations of 2-ClPh and Cl^- in the irradiated NaMOR mixtures at pH 5.7 and 8.6. The figure was reprinted with permission from reference by Kumagai, 2015.

4.2.3. Radiation-chemical yield of Cl^- production

The radiation-chemical yield of Cl^- production was evaluated for a precise comparison in the degradation efficiency between the zeolite mixtures and aqueous solution without the zeolites. In order to evaluate the radiation-chemical yields, the dependence of the quantity of produced Cl^- (in mol unit) on the adsorbed energy (in J unit) was calculated. Fig. 5 shows the dependence of the Cl^- quantity on the adsorbed energy, calculated from the result at pH 5.7 in Fig. 4. Fig. 5 contains the result of aqueous solution containing $4.4 \times 10^{-4} \text{ mol} \cdot \text{dm}^{-3}$ 2-ClPh, which corresponds to the concentration of dissolved 2-ClPh in the mixture. The absorbed energy was calculated as the total energy deposited on the mixture, which is the sum of the absorbed energy of aqueous solution and of NaMOR. The absorbed energy of NaMOR was taken into account because NaMOR existed in the mixture samples during the γ -ray

irradiation and the reaction of 2-CIPh adsorbed on NaMOR is expected to contribute to the Cl^- production. The radiation-chemical yields were obtained as the slope of the dose dependences, and are $(7.9 \pm 0.4) \times 10^{-8}$ and $(8.6 \pm 0.4) \times 10^{-8} \text{ mol} \cdot \text{J}^{-1}$ for the mixture and the aqueous solution, respectively.

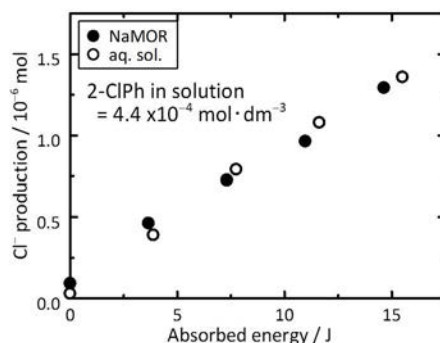

FIG. 5. Cl^- production in the mixture and in the aqueous solution containing 2-CIPh at $4.4 \times 10^{-4} \text{ mol dm}^{-3}$. The figure was reprinted with permission from reference by Kumagai, 2015.

The radiation-chemical yield of Cl^- production in the mixture seems to be about 10% lower than that in the reference solution or comparable within the experimental errors. Therefore, the result can be interpreted as showing that adsorbed 2-CIPh was degraded on NaMOR to release Cl^- into aqueous solution. The result pointed out that the addition of zeolites is not expected to enhance the radiolytic degradation by several orders of magnitude like “catalysts”. However, employing a zeolite strongly adsorbing organics would improve the degradation yield of a dilute aqueous compound.

4.2.4. Effect of $\text{SiO}_2/\text{Al}_2\text{O}_3$ ratio of zeolite composition

We examined the degradation of 2-CIPh in the mixture with a high-silica mordenite-type zeolite, HMOR. Zeolite materials with high $\text{SiO}_2/\text{Al}_2\text{O}_3$ ratios show hydrophobic properties. These zeolites have high absorption performances on organic molecules from aqueous solution [21]. Therefore, we expected HMOR to function as an adsorbent and as a reaction media of adsorb 2-CIPh. HMOR was mixed with the aqueous 2-CIPh solution and the decrease in the 2-CIPh concentration was measured to evaluate the adsorption. HMOR showed an excellent adsorption performance. HMOR adsorbed above 99% of 2-CIPh even when the adsorbed quantity of 2-CIPh was $2.2 \times 10^{-1} \text{ mol} \cdot \text{kg}$. The mixtures were irradiated with γ -rays and the Cl^- production was measured. High productions of Cl^- were also observed for the irradiated HMOR mixtures as shown in Fig. 6 with the yields in the NaMOR mixtures and in the aqueous solutions for comparison. The Cl^- production in HMOR mixture was as high as that in the aqueous solution containing an order of magnitude higher concentrations of 2-CIPh. The results show that the combined usage of adsorption on HMOR improved the degradation of dilute 2-CIPh in aqueous solution.

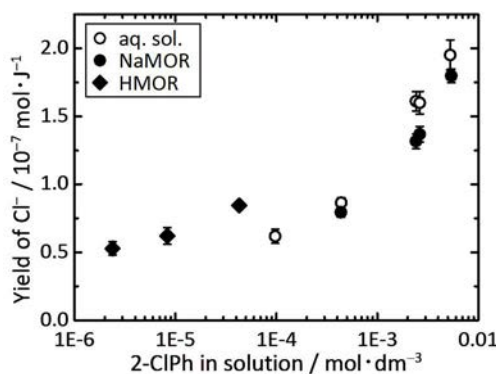

FIG. 6. Yields of Cl⁻ production in HMOR mixture, in NaMOR mixture and in aqueous solution.

4.3. Treatment of chlorinated organic pollutants in wastewater by combination method of zeolite adsorbent with ionizing radiation

Decomposition of clofibrate and triclosan in pure water at 5 $\mu\text{mol dm}^{-3}$ was investigated by γ -ray irradiation. Concentrations of these pharmaceuticals/antibiotics exponentially decreased with increasing dose and reached zero at 180 Gy. Dechlorination efficiency of chlorinated organic pollutants in water by ionizing radiation is important factor for reduction of toxicity. The dechlorination efficiencies of clofibrate and triclosan aqueous solutions were evaluated as the concentration of Cl⁻ produced by ionizing radiation. Concentrations of Cl⁻ in aqueous solution of 5 $\mu\text{mol dm}^{-3}$ clofibrate or triclosan in HMOR mixture (solid/liquid = 2/3) were investigated by γ -ray irradiation as shown in Fig. 7. Production yield of Cl⁻ by use of HMOR system was about twice higher than that in aqueous solution.

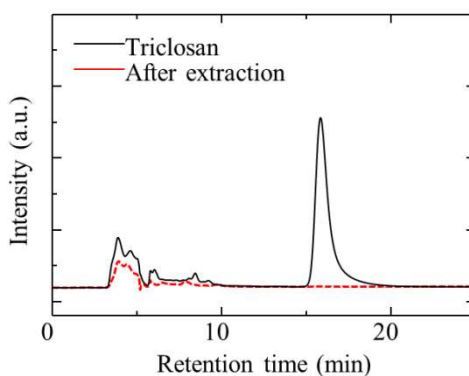

FIG. 7. Chromatogram of 5 $\mu\text{mol dm}^{-3}$ triclosan in real wastewater before and after treatment of HMOR.

HMOR adsorbent was contributed for effective reduction of chlorinated pharmaceuticals/antibiotics in the HMOR mixture.

Treatments of clofibrate and triclosan in “real” wastewater at 5 $\mu\text{mol dm}^{-3}$ were also investigated by γ -ray irradiation with and without HMOR adsorbent. Required dose for elimination of clofibrate and triclosan in real wastewater was estimated both 1000 Gy, which were about 5 times higher than that in pure water. Decomposition efficiencies of these chlorinated pharmaceuticals/antibiotics by ionizing radiation were considered to be interfered by the dissolved organic impurities in the wastewater. Triclosan in real wastewater was

adsorbed completely in HMOR as shown in Fig. 8, and it was the same result even clofibrate in real wastewater.

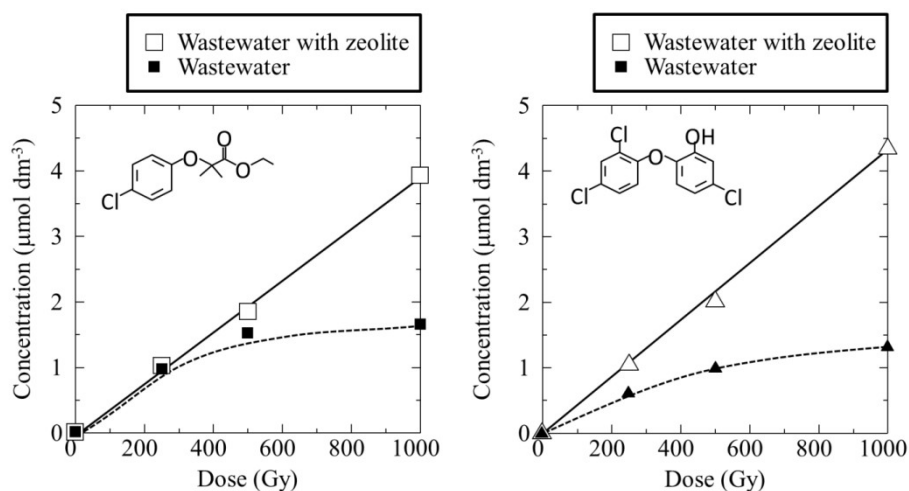

FIG. 8. Concentration of Cl⁻ produced by irradiation in real wastewater and in HMOR mixture, solid/liquid = 2/3, aerated. The initial concentrations of dissolved (left) clofibrate and (right) iclosan were 5 mmol dm⁻³

These results indicated that organic impurities did not affect the adsorption of chlorinated pharmaceuticals/antibiotics to HMOR under the conditions. Concentration of Cl⁻ in real wastewater of 5 µmol dm⁻³ clofibrate or triclosan in HMOR mixture (solid/liquid = 2/3) was investigated by γ -ray irradiation as shown in Fig. 9.

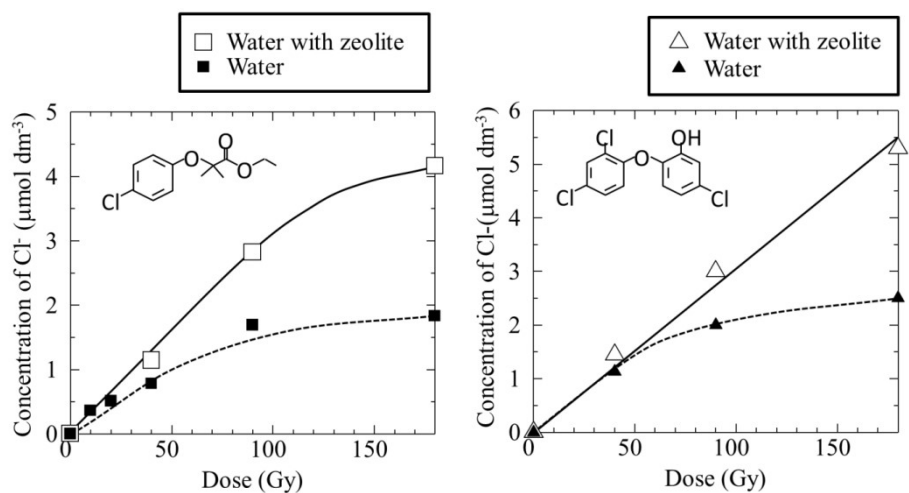

FIG. 9. Concentration of Cl⁻ produced by irradiation in aqueous solution and in HMOR mixture, solid/liquid = 2/3, aerated. The initial concentrations of dissolved (left) clofibrate and (right) triclosan were 5 mmol dm⁻³.

The production yields of Cl⁻ in real wastewater decreased compared to the results of the pure water because of organic impurities as shown in Fig. 7. The production yield of Cl⁻ by use of HMOR system, however, was higher than that in real wastewater, and HMOR adsorbent was also contributed for effective reduction of toxicity of chlorinated pharmaceuticals/antibiotics in real wastewater.

5. SUMMARY

Chlorinated pharmaceuticals and antibiotics in real wastewater were decomposed by γ -ray irradiation, but required dose for treatment was higher compared with one in pure water because of organic impurities. Trace amounts of these chlorinated chemicals were adsorbed on HMOR zeolite from the real wastewater without being disturbed by the impurities, and decomposed by γ -ray irradiation. The combination method of ionizing radiation with HMOR zeolite has the potentiality for wastewater treatment containing chlorinated pharmaceuticals and antibiotics.

REFERENCES

- [1] CARSON, R., "Silent Spring", Houghton Mifflin, (1962).
- [2] COLBORN, T., DUMANOSKI, D., PETERSON, J., *Our Stolen Future, A PLUME BOOK*, (1996) New York.
- [3] OHTAKE, F., TAKEYAMA, K., MATSUMOTO, T., KITAGAWA, H., YAMAMOTO, Y., NOHARA, K., TOHYAMA, C., KRUST, A., MIMURA, J., CHAMBON, P., YANAGISAWA, J., FUJII-KURIYAMA, Y., KATO, S.,. Modulation of estrogen receptor signaling by association with the activated dioxin receptor. *Nature*, **423**, (2003)545–550.
- [4] FENT, K., WESTON, A.A., CAMINADA, D., *Ecotoxicology of human pharmaceuticals. Aquatic toxicology*, **76**, (2006). 122–159.
- [5] COOPER, E.R., SIEWICKI, T.C., PHILLIPS K., Preliminary risk assessment database and risk ranking of pharmaceuticals in the environment. *Science of The Total Environment*, **398**, (2008) 26–33.
- [6] CUNNINGHAM V.L., BINKS, S.P., OLSON, M.J., Human health risk assessment from the presence of human pharmaceuticals in the aquatic environment. *Regul. Toxicol. Pharmacol.*, **53**, (2009) 39–45.
- [7] OAKS, J.L., GILBERT, M., VARANI, M.Z., WATSON, R.T., METEYER, C.U., RIDEOUT, B.A., SHIVAPRASAD, H.L., AHMED, S., CHAUDHRY, M.J.I., ARSHAD, M., MAHMOOD, S., ALI, A., KHAN, A.A., Diclofenac residues as the cause of vulture population decline in Pakistan. *Nature*, **427**, (2004) 630–633.
- [8] ALONSO, S. G., CATALÁ, M., MAROTO, R.R., GIL, J.L.R., MIGUEL, Á.G., VALCÁRCEL Y., Pollution by psychoactive pharmaceuticals in the rivers of Madrid metropolitan area (Spain). *Environment International*, **36**, (2010). 195 –201.
- [9] COOPER, W.J., CURRY, R.D., O'SHEA, K.E., *Environmental application of ionizing radiation*. (1998).
- [10] GETOFF, N., Factors influencing the efficiency of radiation-induced degradation of water pollutants. *Radiat. Phys. Chem.*, **65**, (2002) 437–446.
- [11] HAN, B.S., JAEN, K., KO, J., KIM, Y., CHUNG, W., MAKAROV, I.E., PONOMAREV, A.V., PIKAEV, A.K., Combined electron-beam and biological treatment of dyeing complex wastewater. Pilot plant experiments. *Radiat. Phys. Chem.*, **64**, (2002) 53–59.
- [12] KIMURA, A., TAGUCHI, M., ARAI, H., HIRATUKA, H., NAMBA, H. KOJIMA, T., Radiation-induced decomposition of trace amount of 17 β -estradiol in water. *Radiat. Phys. Chem.*, **69**, (2004) 295–301.
- [13] KIMURA, A., TAGUCHI, M., OHTANI, Y., SHIMADA, Y., HIRATSUKA, H., AND KOJIMA, T., Treatment of wastewater having estrogen activity by ionizing radiation. *Radiation Physics and Chemistry*, **76**, (2007) 699–706.
- [14] BORRELY, S.I., GONCALVES, A.A., OIKAWA, H., DUARTE, C.L., ROCHA, F.R., Electron beam accelerator for detoxification of effluents. When radiation processing can enhance the acute toxicity? *Radiat. Phys. Chem.*, **71**, (2004). 453 –456.

- [15] HE, S, WANG, J., YE, L., ZHANG, Y., YU, J., Removal of diclofenac from surface water by electron beam irradiation combined with a biological aerated filter. *Radiat. Phys. Chem.*, **105**, (2014) 104–108.
- [16] KIM, H.Y., JEOH, J. YU, S., LEE, M.-J, KIM, T.-H, KIM, S.D., Reduction of toxicity of antimicrobial compounds by degradation processes using activated sludge, gamma radiation, and UV, *Chemosphere*, **93**, (2013) 2480–2487.
- [17] SZABÓ, L., TÓTH, T., HOMLOK, R., RÁCZ, G., TAKÁCS, E., WOJNÁROVITS, L., Hydroxyl radical induced degradation of salicylates in aerated aqueous solution. *Radiat. Phys. Chem.*, **97**, (2014) 239–245.
- [18] ROSS, P., BURTON, G.A., GREENE, M., HO, K., MEIER, P., SWEET, L., AUWARTER, A., BISPO, A., DOE, K., ERSTFELD, K., GOUDEY, S., GOYVAERTS, M., HENDERSON, D., JOURDAIN, M., LENON, M., PANDARD, P., QURESHI, A., ROWLAND, C., SCHIPPER, C., SCHREURS, W., TROTTIER, S., VAN AGGELEN, G., Interlaboratory precision study of a whole sediment toxicity test with bioluminescent bacterium *Vibrio fischeri*. *Environmental Toxicology*, **41** (1999) 339–345
- [19] ZHANG, G., MAO, Y., THOMAS, J.K., Surface chemistry induced by high energy radiation in silica of small particle structures. *J. Phys. Chem. B*, **101**, (1997) 7100–7113.
- [20] SWYLER K.J., BARLETTA, R.E., Irradiation of zeolite ion-exchange media. NUREG/CR-2785, BNL-NUREG-51551. (1983)
- [21] KHALID, M., JOLY, G., RENAUD, A., MAGNOUX, P., Removal of phenol from water by adsorption using zeolites. *Industrial & Engineering Chemical Research*, **43**, (2004) 5275–5280.
- [22] KIMURA, A., OSAWA, M. TAGUCHI, M., Decomposition of persistent pharmaceuticals in wastewater by ionizing radiation. *Radiat. Phys. Chem.*, **81**, (2012) 1508–1512.
- [23] KUMAGAI, Y., Degradation of 2-chlorophenol by γ -ray irradiation in zeolite/water mixtures. *Radiation Chemistry*, **99**, (2015) 53–56. [in Japanese]

REMOVAL OF EDCS FROM INDUSTRIAL SLUDGE BY E-BEAM

B. HAN¹, J.K. KIM¹, Y.R. KIM¹, S.T. JUNG¹, J.H. PARK², J.S. CHO², H.O. PARK³, W.S. SHIN³

¹EB TECH CO., LTD., DAEJEON

²Korea Dyeing Technology Center, Daegu

³Kyungbuk National University, Daegu

Republic of Korea

Abstract

Endocrine disrupting chemicals (EDCs) and potential EDCs are mostly man-made, found in various materials such as pesticides, metals, additives or contaminants in food, and personal care products. EDCs have been suspected to be associated with altered reproductive function in males and females; increased incidence of breast cancer, abnormal growth patterns and neuro-developmental delays in children, as well as changes in immune function. A number of processes were investigated regarding their removal potential of endocrine disrupters. Those processes are ferric chloride coagulation, powdered activated carbon, magnetic ion exchange combined with microfiltration (MF) or ultrafiltration (UF), as well as nanofiltration (NF) and reverse osmosis (RO), however, they show some good result of removal of EDCs in aqueous solution, but do not show good removal efficiency when EDCs are in sludge [1].

The high energy ionizing radiation has the ability to remove the EDCs with a very high degree of reliability and in a clean and efficient manner. The ionizing radiation interacts with EDCs both directly and indirectly. Direct interaction takes place with EDCs and the structure of EDCs has destroyed or changed. During indirect interaction, radiolysis products of water result in the formation of highly reactive intermediates that then react with the target molecules, culminating in structural changes. To confirm the radiation reduction of EDCs in industrial sludge, a pilot scale experimental system with 2.5 MeV 100 kW accelerator has set up to. The experimental result showed the over 80~90% of reduction of Nonylphenol and Diethylhexyl phthalate (DEHP) at around 10 kGy of absorbed doses

1. OBJECTIVE OF THE RESEARCH

Endocrine disrupting chemicals may impact a broad range of health effects. Although there is limited evidence to prove that low-dose exposures are causing adverse human health effects, there is a large body of research in experimental animals and wildlife suggesting that endocrine disruptors may cause:

- Reductions in male fertility and declines in the numbers of males born.
- Abnormalities in male reproductive organs.
- Female reproductive health issues, including fertility problems, early puberty, and early reproductive senescence.
- Increases in mammary, ovarian, and prostate cancers.
- Increases in immune and autoimmune diseases, and some neuro-degenerative diseases.

Typical known and suspected endocrine disrupting chemicals are listed in Table 1.

TABLE 1. LIST OF KNOWN AND SUSPECTED ENDOCRINE DISRUPTING CHEMICALS

Known EDCs	Suspected EDCs
Persistent Organohalogens	2,4-dichlorophenol,
dioxins/furans, PCBs, PBBs, octachlorostyrene	Diethylhexyl adipate,
hexachlorobenzene, pentachlorophenol	Benzophenone,
Pesticides	N-butyl benzene
2,4,5-T, 2,4-D, alachlor, aldicarb, amitrole,	
atrazine, benomyl, beta-HCH, carbaryl,	
chlordane, cypermethrin, DBCP, DDT, DDT	
metabolites, dicofol, dieldrin, endosulfan,	
esfenvalerate, ethylparathion, fenvalerate, lindane,	
heptachlor, h-epoxide, kelthane, kepone, malathion,	
mancozeb, maneb, methomyl, methoxychlor,	
metribuzin, mirex, nitrofen, oxychlordane,	
metiram, permethrin, synthetic pyrethroids,	
toxaphene, transnonachlor, tributyltin	
Phthalates	
DEHP (Di-ethylhexyl phthalate), DHP (Di-hexyl phthalate)	
BBP (Butyl benzyl phthalate), DprP (Di-propyl phthalate)	
DBP (Di-n-butyl phthalate), DCHP (Dicyclohexyl phthalate)	
DPP (Di-n-pentyl phthalate), DEP (Diethyl phthalate)	
Benzo(a)pyrene	
Heavy metals : mercury, lead, cadmium	
Penta-to Nonyl Phenols	
Bisphenol A	
Styrene dimers and trimers	

2. INTRODUCTION

Endocrine disruptors are chemicals that may interfere with the humane body's endocrine system and produce adverse developmental, reproductive, neurological, and immune effects in both humans and wildlife. A wide range of substances, both natural and man-made, are thought to cause endocrine disruption, including pharmaceuticals, dioxin and dioxin-like compounds, polychlorinated biphenyls, DDT and other pesticides, and plasticizers such as bisphenol A. These chemicals are found in many of the everyday products we use, including some plastic bottles and containers, liners of metal food cans, detergents, flame retardants, food, toys, cosmetics, and pesticides. Although limited scientific information is available on the potential adverse human health effects, concern arises because endocrine disrupting chemicals present in the environment at very low levels have been shown to have adverse effects in wildlife species as well as in laboratory animals. The difficulty of assessing public health effects is increased by the fact that people are typically exposed to multiple endocrine disruptors simultaneously.

In the effluent samples collected from seven Wastewater Treatment Plants (WWTPs) in the Republic of Korea, Tris (2-chloroethyl) phosphate (TCEP), iopromide, naproxen, carbamazepine, and caffeine were quite frequently observed (480%) in both surface waters and effluents. The analytes of greatest concentration were iopromide, TCEP, sulfamethoxazole, and carbamazepine. However, the primary estrogen hormones, 17 α -ethynylestradiol and 17 β -estradiol, were rarely detected, while estrone was detected in both surface water and wastewater effluent [2].

Conventional processes of coagulation, filtration and adsorptions were introduced regarding their removal potential of endocrine disruptors; however, such technologies may be

significant risks in water recycling where contaminants accumulate to comparably high quantities and may be released during treatment. This requires further investigations to understand how easily those contaminants are released and where they accumulate in the water cycle [3, 4].

Chemicals that are known endocrine disruptors include diethylstilbestrol (the synthetic estrogen DES), dioxin and dioxin-like compounds, polychlorinated biphenyls (PCBs), DDT, and some other pesticides. Bisphenol A (BPA) is a chemical produced in large quantities for use primarily in the production of polycarbonate plastics and epoxy resins. Di (2-ethylhexyl) phthalate (DEHP) is a high production volume chemical used in the manufacture of a wide variety of consumer food packaging, some children's products, and some polyvinyl chloride (PVC) medical devices. Phytoestrogens are naturally occurring substances in plants that have hormone-like activity. Examples of phytoestrogens are genistein and daidzein, which can be found in soy-derived products.

The high energy ionizing radiation from radioactive sources such as ^{60}Co or an EB accelerator has the ability to remove the EDCs with a very high degree of reliability and in a clean and efficient manner. The ionizing radiation interacts with matter both directly and indirectly. Direct interaction takes place with EDCs and the structure of EDCs has destroyed or changed. During indirect interaction, radiolysis products of water result in the formation of highly reactive intermediates that then react with the target molecules, culminating in structural changes.

3. PREVIOUS WORKS

The sludge resulting from municipal or industrial wastewater treatment is in the form of a liquid or semisolid liquid that typically contains 0.25–12% solids by weight, depending on the operations and processes used. Of the components removed in wastewater treatment, sludge is by far the greatest in volume, and the problems associated with its processing and disposals are complex because:

- It is composed of the substances responsible for the offensive character of untreated wastewater;
- The portion of sludge produced from biological treatment and requiring disposal is composed of the organic matter in the wastewater, but in a form, that can decompose and become offensive;
- Only a small portion of the sludge is solid matter.

In addition to those, the industrial sludge contains the EDCs, and they may impact a broad range of health effects. When absorbed in the body, an endocrine disruptor can decrease or increase normal hormone levels, mimic the body's natural hormones, or alter the natural production of hormones.

The previous works are mainly to disinfect the microorganisms since the sludge generated by a sewage plant contains a high concentration of pathogens, which limits the reuse of this waste - a rich source of plant nutrients, the disposal of sewage sludge in its original form is an economic loss to society [5, 6]. However, the industrial sludge is used to send to incineration plant or sanitary landfilling area, but to cause the secondary problems by the release of EDCS to environment. Thus, it is necessary to enhance the treatment process to ensure the removal of the EDCs with a high degree of reliability.

A number of processes were investigated regarding their removal potential of endocrine disruptors. Those processes are ferric chloride coagulation, powdered activated carbon, magnetic ion exchange combined with microfiltration (MF) or ultrafiltration (UF), as well as nanofiltration (NF) and reverse osmosis (RO). Key findings were a negligible removal (<10%) of estrone with ferric chloride coagulation and very high removal (>90%) with powdered activated carbon. Magnetic ion exchange varied from 40 to 70% removal depending on solution chemistry and dissociation of the hormone. Nanofiltration showed an initial retention of 70–95% but for most membranes this retention dropped significantly after an initial filtration period. For some reverse osmosis membranes retention was similar to nanofiltration, but others showed a very high and stable retention of the compounds. Microfiltration also showed near complete retention initially followed by a drop to 0% as expected. The presence of matrix compounds from water and wastewaters affected retention for some membranes. These results, while initially surprising, showed a common theme, which is the adsorption of polar contaminants on materials used in treatment. This includes ion exchange resins, membranes and many other materials that come in contact with the trace contaminants. Implications of those findings are that there may be a significant risk in water recycling where contaminants accumulate to comparably high quantities and may be released during treatment.

4. MATERIALS AND METHODS

4.1. Experimental System

To confirm the use of EB as to reduce the EDCs in industrial sludge, a pilot scale experiment was conducted in EB TECH with samples from the Textile Dyeing Complex in Daegu City which has the capacity of 500 m³/day equipped with the conventional belt press and filter press system. The experimental scheme is shown in Fig. 1, and typical data of the sludge is in Tables 2 and 3.

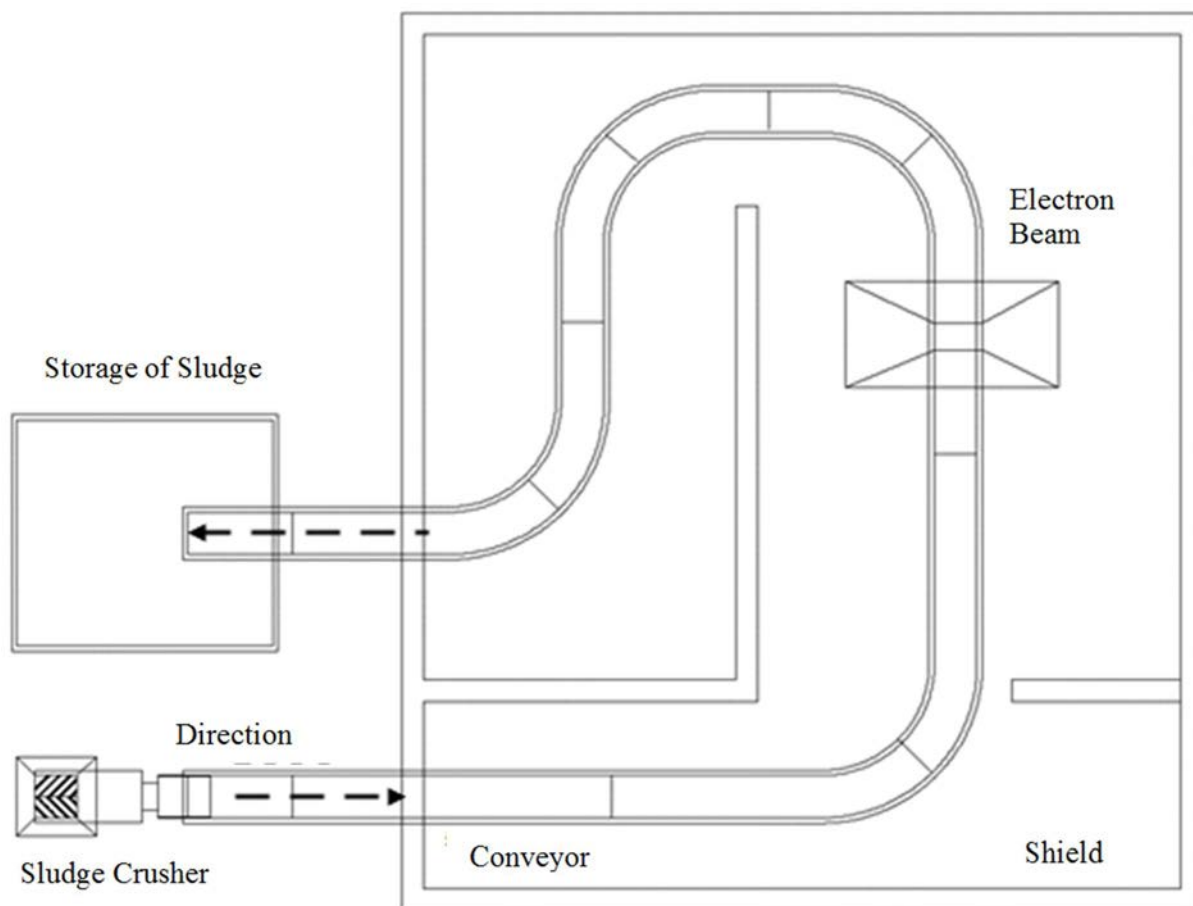

FIG. 1. Pilot scale industrial sludge treatment system at continuous operation mode.

In these experiments, electron accelerator of 2.5 MeV, 100 kW with the dose rate of 40 kGy/s is used with the laboratory unit, schematically shown in Fig. 1, was constructed for irradiation under continuous treatment conditions. The initial samples (sludge cakes) are placed in crusher, which produces crushed granular sludge. The crushed sludge is delivered to cart tray by hopper. Thickness of sludge is controlled from 2 to 10 mm; where to consider the range of 2.5 MeV electrons in sludge. The rate of sludge moving under the beam is controlled within the range of 5–10 m/min. The sludge moved under the beam window is treated by electron beam, and then irradiated sludge is collected into the special container. The experiments were conducted with the doses up to 50 kGy at atmospheric temperature (20~25°C).

TABLE 2. MAJOR COMPOUNDS IN SLUDGE CAKES OF TEXTILE DYEING COMPLEX

Items	Unit	Result	Method
Carbon (fixed)	%	0.32	ASTM D 5142-04
Ash	%	27.80	ASTM D 5142-04
Water	%	70.55	KS E 3804 : 1996
Volatile Matter	%	66.96	ASTM D 5142-04

TABLE 3. ELEMENT ANALYSIS IN SLUDGE CAKES OF TEXTILE DYEING COMPLEX

Items	Unit	Result	Method
C	%	50.9	Element Analyzer
H	%	7.5	Element Analyzer
N	%	5.4	Element Analyzer
O	%	8.2	Element Analyzer
S	%	1.0	Element Analyzer
Cl	mg/kg	240	EN 14582 : 2007(IC)
Ash	%	27.6	KS M 0009 : 2005

4.2. Analysis of EDCs

The analysis of EDCs requires precision and accuracy since the contents of EDCs are relatively small amounts in the sludge. Thus, to achieve the sensitivity, accuracy, precision, selectivity or specificity, and linearity, we also conducted the blank test, control test, standard addition test etc. Two different extraction methods were used in this experiment. The first method is to extract the EDCs by SPE (Solid phase extraction) method from the absorbed sludge by sonicated in water solution. DCM (Dichloromethane), n-Hexane, ethanol, and acetone are used as for the solvent of sludge. After the turbo vap, the concentrated samples were analysed by LC-MS/MS (Agilent; Liquid chromatography triple Quadropole 6400). Second method is to use solute extractor from the frozen samples. The sludge samples are rapidly freezing with freezer (EYELA, FUD-2100), and then extracted by solute extractor (Dionex; ASE-200), after concentrating (Turbovap), the extracted solute were analysed by LC-MS/MS (Agilent; Liquid chromatography triple Quadropole 6400) without any additional purification process [7, 8].

5. RESULT AND DISCUSSION

5.1. EDCs in Industrial Sludge

The initial EDCs concentration of industrial sludge from Daegu Textile Dyeing Complex was analysed with two different extraction methods (SPE and ASE-200). The data with ASE-200 showed slightly high amount of Nonylphenols and phthalate, whereas Bisphenol-A is not detected or detected as low amount which can be negligible in this experiments. The detailed data is shown in Table 4.

TABLE 4. EDCS IN SLUDGE CAKE OF TEXTILE DYEING COMPLEX

Materials	SPE	ASE-200
Nonylphenols (mg/kg)	0.982	1.245
phthalate (mg/kg)	1.374	2.013
Bisphenol-A	N.D	0.017

5.2. Experimental Result

5.2.1. Removal of NP and DEHP with electron beam

The initial concentration Nonylphenol in raw sludge was 1.5 mg/kg and it was confirmed at duplicate analysis. The experimental result of Nonyl phenol is shown Fig. 2. The concentration of Nonylphenol decrease with absorbed doses, and showed the 83% of removal at 10 kGy and 95% removal at 20 kGy.

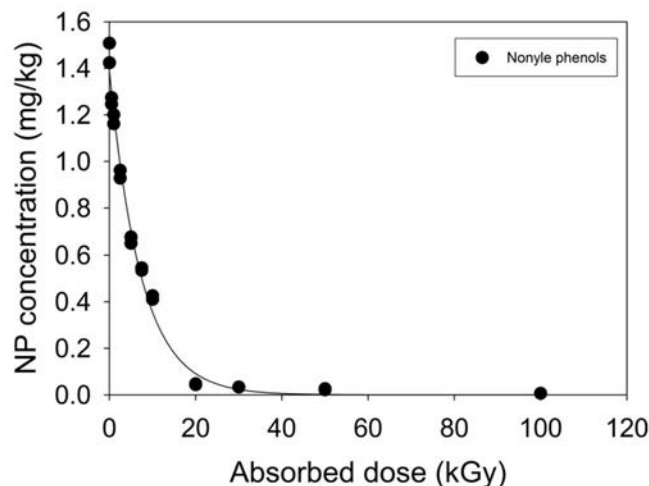

FIG. 2. Decrease of Nonylphenol in sludge cake from Textile Dyeing Complex

The experimental data of DEHP showed the similar trend with Nonylphenol. The initial concentration Nonylphenol in raw sludge was 0.7 mg/kg and it was also confirmed at duplicate analysis. The experimental result of DEHP is shown Fig. 3. The concentration of DEHP decrease with absorbed doses, and showed the 80% and 90% of removal at 10 and 20 kGy respectively.

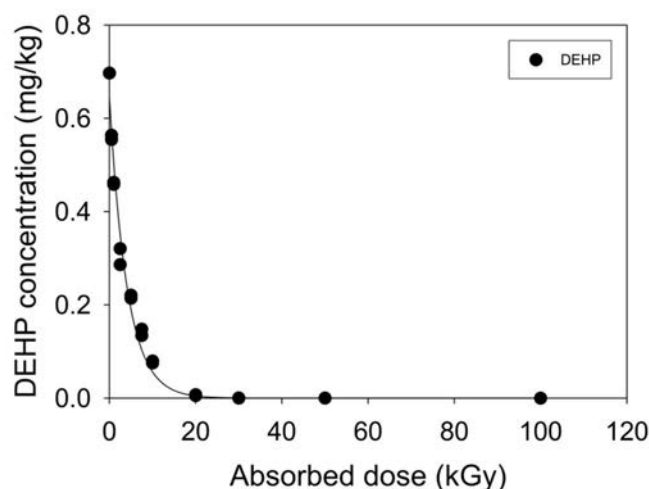

FIG. 3. Decrease of DEHP in sludge cake from Textile Dyeing Complex.

The absorbed doses required to remove NP and DEHP to a certain levels are higher than the required doses reported by others who made the experiments with the EDCs in aqueous system [9]. Those are mainly due that the EDCs are absorbed to sludge and it makes difficult in the radical reaction.

5.2.2. Effect of sludge thickness on the treatment

To find the optimum thickness of sludge, the experiments with different sludge thickness from 2mm to 10mm has conducted. The initial concentration of Nonylphenol has increased by

intentional addition of Nonylphenol for measurement in model sludge. The experimental result is shown Fig. 4. The concentration of Nonylphenol decrease with the sludge thickness, and the data will be used for estimation of treatment cost.

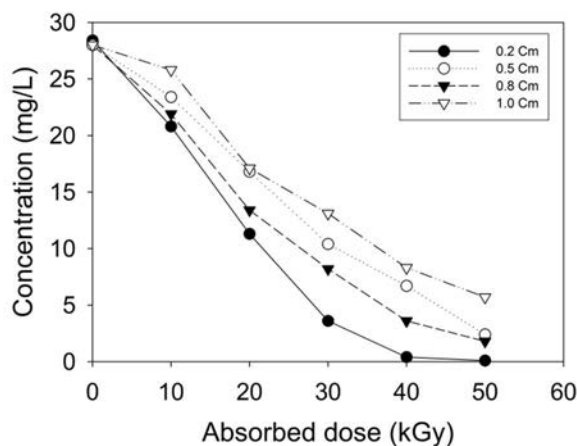

FIG. 4. Decrease of Nonyl phenol on the thickness of sludge cakes.

5.2.3. Long term operation in the treatment of Nonylphenol and DEHP

To confirm the stability and reproducibility of the treatment, long term operation experiments were conducted on Nonylphenol and DEHP removal. The dewatered sludge from the textile dyeing complex has been collected daily up to 2 months from March to May 2014 and such sample sludge (60 kg/d) were treated with pilot scale plant at 10 kGy. The long term operation results are in Fig. 5 and Fig. 6. Even in the sludge from the same plant, the initial contents of Nonylphenol and DEHP were varied with days. It comes from the diversities of dyes, chemicals used in dyeing processes and also from the instrumental instabilities in the measurement.

The initial concentration of Nonylphenol varies from 0.7 mg/kg to 1.5 mg/kg daily during the experiments. That sludge was treated with electron beam of 2.5 MeV with 10 kGy at the thickness of 10 mm. The remaining Nonylphenol were measured to 0.05–0.3 mg/kg, and the higher residues of Nonylphenol with higher initial concentration. The removal rate of Nonylphenol is about 85% and it is quite good to apply industrial scale application.

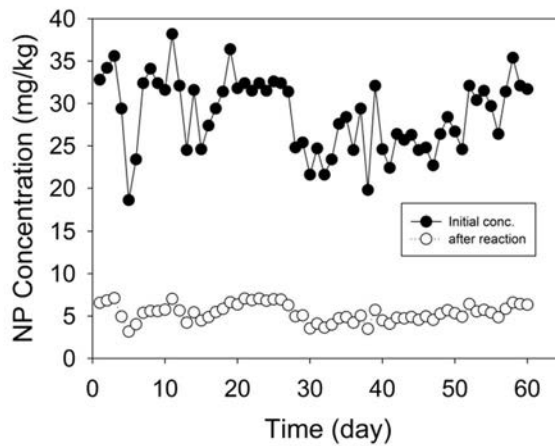

FIG. 5. Decrease of Nonyl phenol at long term (60days) operation with 10kGy.

In Fig. 6., the result of long term treatment of DEHP with electron beam is shown. The initial concentration of DEHP varies from 0.35 mg/kg to 0.7 mg/kg daily during the experiments. That sludge was also treated with electron beam of 2.5 MeV with 10 kGy at the thickness of 10 mm. The remaining DEHP were measured to 0.05 –0.1 mg/kg, and similar to Nonylphenol, the higher residues with higher initial concentration. The removal rate of Nonylphenol is about 80% and it is quite good to apply industrial scale application.

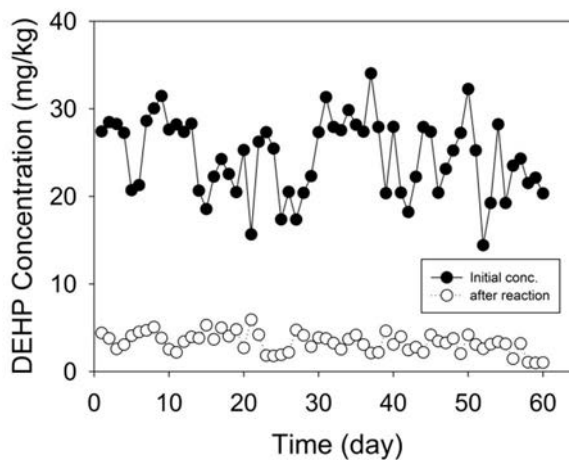

FIG. 6. Decrease of DEHP at long term (60days) operation with 10kGy.

6. SUMMARY

Experimental System to irradiate the industrial sludge with electron beam (2.5 MeV) has been set up and showed continuous treatment up to 60 kg/d with cart carriage.

Analytical methods to measure the EDCs (Nonylphenol, DEHP, BPA etc.) were developed based on HPLC and GC-MS. The industrial sludge from the textile dyeing process showed little contamination with NP (1.5 mg/kg) and DEHP (0.7 mg/kg), and BPA has not detected.

The removal ratio of Nonylphenol and DEHP was 83% and 80% at 10 kGy and 95% and 90% at 20 kGy respectively, and it is higher than the required doses reported by others who made the experiments with the EDCs in aqueous system.

Long term operation of pilot scale at 60 days at 10 kGy shows the removal ratio of Nonylphenol and DEHP 85% and 80% respectively and it shows this technology is good to apply in industrial scale application.

REFERENCES

- [1] SECKLER, D., et al., Water scarcity in the twenty-first century, *International Journal of Water Resources Development*, **15**, (1999) 29–42.
- [2] KIM, S.D. et al., Occurrence and removal of pharmaceuticals and endocrine disruptors in South Korean surface, drinking, and waste waters, *Water Research* **41**, (2007) 1013–1021.
- [3] COLBORN, T., et al., Developmental Effects of Endocrine-Disrupting Chemicals in Wildlife and Humans, *Environmental Health Perspectives*, **101(5)**, (1993) 378–384.
- [4] NATIONAL INSTITUTES OF HEALTH (NIH), *Endocrine Disruptors*, U.S. Department of Health and Human Services. (2012).
- [5] PONOMAREV, A.V. et al., Combined electron beam and adsorption purification of water from cadmium and Mercury using materials from vegetable origin as sorbents, *Radiation Physics and Chemistry* **494(4)**, (1997) 473–479.
- [6] HAN, B. et al., Electron beam treatment of textile dyeing wastewater : operation of pilot plant and construction of industrial plant, *Water Science and Technology* **52(10,11)**, (2005) 317–324.
- [7] KIM, Y.S., et al., Estrogen equivalent concentration of individual isomer-specific 4-nonylphenol in Ariake sea water in Japan, *Marine Pollution Bulletin* **51**, (2005) 850~856.
- [8] ZHANG, H., et al., Enantioselective separation and determination of single nonylphenol isomers, *Chemosphere*, **66**, (2007) 594~602.
- [9] KOMORI, K., et al, Occurrence of nonylphenol, nonylphenol ethoxylate surfactants and nonylphenol carboxylic acids in wastewater in Japan”, *Water Environmental Federation* **305** (2005).

ENHANCED BIODEGRADABILITY OF PHAMACEUTICALS AND PERSONAL CARE PRODUCTS BY IONIZING RADIATION

KIM H.Y.¹, KIM T.-H.¹, YU S.¹, LEE M.J.¹, LEE O-M²

¹Advanced Radiation Technology Institute, Korea Atomic Energy Research Institute

²Quarantine Technology Center, Animal and Plant Quarantine Agency Plant
Republic of Korea

Abstract

The radiolytic degradation of antibiotic compounds including lincomycin (LMC), sulfamethoxazole (SMX), and tetracycline (TCN), and the change of biodegradability of the radiation-treated target compounds were evaluated. As a result, the degradation of target antibiotics by hydrolysis, biodegradation, and gamma irradiation showed a compound-dependent manner. However, the biodegradability of all target compounds was enhanced by the gamma irradiation. The enhanced biodegradability after gamma irradiation (2 kGy) followed the trend of LMC (18.89%) < SMX (28.33%) < TCN (36.62%), indicating that gamma irradiation might transform non-biodegradable compounds into biodegradable. Consequently, the effective degradation of non-biodegradable antibiotics can be accomplished by ionizing radiation followed by biodegradation. This result indicated that ionizing radiation technology would be useful to enhance biodegradability of the recalcitrant pollutants and can facilitate further degradation of residuals or intermediates in the effluent when discharged into surface water.

1. OBJECTIVE OF THE RESEARCH

The objectives were to evaluate the removal efficiency of sulfamethoxazole (SMX), tetracycline (TCN), and lincomycin (LMC) using gamma ray and to investigate the change of biodegradability of the target compounds after gamma irradiation treatment.

2. INTRODUCTION

Concerns regarding pharmaceutical and personal care products (PPCPs) including antibiotic compounds have recently increased owing to their enormous consumption [1, 2], ubiquitous contamination [3-5], and specific biological effect, which can be detrimental to the environment.

Among these, tetracycline (TCN), lincomycin (LMC), and sulfamethoxazole (SMX) are representative antibiotic compounds which are widely detected in aquatic environment. They have been monitored in influent at the concentration of 48 ± 3.21 $\mu\text{g/L}$ (TCN), 0.36 ± 0.05 $\mu\text{g/L}$ (LMC), and 0.31 ± 0.03 $\mu\text{g/L}$ (SMX). In effluent, they have been determined as 3.6 ± 0.31 $\mu\text{g/L}$, 0.51 ± 0.11 , and 0.27 ± 0.04 , respectively, indicating low removal efficiency of treatment plants [6]. Therefore, they have been widely detected in surface water, showing 0.11 $\mu\text{g/L}$ (TCN), 0.06 $\mu\text{g/L}$ (max. 0.73 $\mu\text{g/L}$, LMC), and 0.15 $\mu\text{g/L}$ (max. 1.9 $\mu\text{g/L}$, SMX) [4]. In addition, TCN and LMC were regarded as high priority veterinary medicines due to their potential to enter the environment, their usage, and the hazard which they pose to terrestrial and aquatic organisms [7]. SMX was also considered as priority compound among the 120 human pharmaceuticals when prioritization methodology was applied [8].

Since it is difficult to reduce the consumption of antibiotics, which are difficult to remove using conventional water resource recovery facility equipped with biological and physicochemical treatment processes, advanced technologies for decomposing antibiotics

have been developed [9-11]. Advanced oxidation processes (AOPs), alternative treatment techniques of pollutants in the environment, have been widely developed. Among the various advanced technologies, radiolytic decomposition processes using gamma radiation or electron beams have received attention as alternatives to conventional processes [12, 13]. The complete mineralization of pollutants by AOPs is ideal, but complete mineralization is difficult to accomplish, and high energy costs are required. It was revealed that radiolysis was more cost-effective than other AOPs such as UV or ozone treatment [14]. Therefore, the combination of radiolysis and conventional treatment methods may enhance the degradation efficiency of non-degradable compounds.

This study focused on the ionizing radiation technology that can enhance biodegradability of recalcitrant antibiotic compounds in aqueous solution. Then, the residuals or intermediates in irradiated effluent can be easily eliminated without post-treatment when discharged into surface water. The objectives were to evaluate the removal efficiency of sulfamethoxazole (SMX), tetracycline (TCN), and lincomycin (LMC) using gamma ray and to investigate the change of biodegradability of the target compounds after gamma irradiation treatment.

3. MATERIALS AND METHODS

3.1. Chemical and reagents

Lincomycin (LMC), sulfamethoxazole (SMX), and tetracycline (TCN) were obtained from Sigma-Aldrich (St. Louis, MO, USA). The purity of the target antibiotics was higher than 99%. HPLC grade acetonitrile and methanol was purchased from Sigma-Aldrich and J.T. Baker (USA). All other reagents used for this study were of analytical grade. The chemical structure and physiological properties of the target compounds are shown in Table 1.

TABLE 1. STRUCTURE AND PHYSICOCHEMICAL PROPERTIES OF THE TARGET COMPOUNDS

Compounds	Lincomycin (LMC)	Sulfamethoxazole (SMX)	Tetracycline (TCN)
Group	Macrolide	Sulphonamide	Tetracycline
CAS number	154-21-2	724-46-6	60-54-8
Formula	C ₁₈ H ₃₄ N ₂ O ₆ S	C ₁₀ H ₁₁ N ₃ O ₃ S	C ₂₂ H ₂₄ N ₂ O ₈
MW (g/mol)	406.54	253.28	444.44
pK _a	7.6	1.7, 5.6	3.3, 7.7, 9.7
Log K _{ow}	0.56	0.48	-1.19

3.2. Ionizing gamma irradiation

Gamma irradiation treatment was carried out with a high-level ⁶⁰CO source (Nordion Inc., Canada) at the Korea Atomic Energy Research Institute (Jeongeup, Republic of Korea). The radioactivity of the source was around 1.47×10^{17} Bq (= 397 949 Ci), and the dose rates ranged from 6.3 kGy/h to 14.3 kGy/h depending on the distance from the source (up to 100 kGy). The absorbed doses were measured using an alanine-EPR dosimetry system (ISO/ASTM 51607:2003) (ASTM, 2004). For gamma radiolysis, the aqueous sample solutions containing three antibiotics were placed into 125 mL glass screw cap bottles without a headspace. All solutions were in equilibrium at atmospheric pressure and room temperature (22 ± 2 °C) before irradiation, and were sealed with screw caps to prevent the introduction of air. The gamma irradiation-induced decomposition of LMC, SMX, and TCN was carried out

in aqueous environment at the initial concentration of 17 mg/L. The target compounds were irradiated at different absorbed doses including 0, 0.2, 0.4, 1.0, 1.5, and 2.0 kGy.

3.3. Biodegradation test

A biodegradation test of LMC, SMX, and TCN was conducted for 28 days using the Oxitop system (Oxitop®, WTW Weilheim, Germany) on the basis of closed bottle tests (CBT), following the method of Reuschenbach et al. (2003). The standardized test duration of 28 days allows sufficient time for adaption of microorganisms to the target chemicals (lag phase), degradation (degradation phase), and saturation (plateau phase) [15]. This system offers an individual number of reactors consisting of glass bottles (510 ml) with a carbon dioxide trap (sodium hydroxide) in the headspace. Each bottle was composed of a magnetic stirrer and sealed with a cap containing an electronic pressure indicator. The test was performed with distilled water at a temperature of $22 \pm 2^\circ\text{C}$ in an incubator. The decrease in headspace pressure in the closed bottle was continuously recorded, and the BOD was calculated according to the following equation [16]:

$$\text{BOD} = \frac{M(\text{O}_2)}{RT} \left(\frac{V_{\text{total}} - V_{\text{liquid}}}{V_{\text{total}}} + \alpha \frac{T_{22}}{T_0} \right) \Delta P(\text{O}_2) \quad (1)$$

where $M(\text{O}_2)$ is the molecular weight of oxygen (32 g/mol), R is the gas constant (83.144 mbar/mol K), T_0 is the temperature at 0°C (273.15 K), T_{22} is the incubation temperature at 22°C (295.15 K), V_{Total} is the total volume of the test bottle, V_{Liquid} is the liquid volume in the test bottle, α is the Bunsen absorption coefficient (0.03103), and $\Delta P(\text{O}_2)$ is the difference in the partial pressure of oxygen (mbar). The inoculum was taken from the effluent of a municipal water resource recovery facility (Jeongeup, Republic of Korea). Blank controls including abiotic (no inoculum of microorganisms to non-irradiated target compounds) and biotic (microorganisms were inoculated to non-irradiated compounds) control were also prepared to distinguish the elimination from the abiotic degradation mechanism (e.g. hydrolysis) and biodegradation.

The calculation of biodegradation percentage after 28 days of testing was expressed as the percentage of oxygen taken up by the microbial population in test suspension over the theoretical oxygen demand (ThOD), which is the required amount of oxygen to oxidize a target compound completely [17].

$$\text{Degradation (\%)} = \frac{\text{BOD} - \text{BOD}_{\text{blank}}}{\text{ThOD}} \times 100 \quad (2)$$

$\text{BOD}_{\text{blank}}$ is the BOD of the biotic control (mg/L). ThOD is the theoretical oxygen demand to transform the target compounds ($C_0=17$ mg/L) into CO_2 , H_2O , and NO_3^- (TCN), and CO_2 , H_2O , NO_3^- , and SO_4^{2-} (LMC, SMX).

3.4. Analytical methods

The remaining concentration of each antibiotic by gamma irradiation treatment was measured using high-performance liquid chromatography (HPLC, Agilent 1200 Series, Agilent Technologies, USA). The system consisted of LC pumps, a degasser, an autosampler, and a UV absorbance detector. Fifty microliters of the sample was loaded into the column (XTerra™RP18, 4.6×250 mm) at 30°C with a flow rate of $0.5 \mu\text{l}/\text{min}$. The mobile phase was water containing 0.1% formic acid (A) and acetonitrile (B), and the gradient was programmed

as follows: A:B=90:10 from 0 to 1 min, and raised linearly to 10:90 from 1 to 15 min, continued from 15 to 18 min, and then returned to 90:10 from 18 to 20 min. The detection was performed at 210, 254, and 350 nm for LMC, SMX, and TCN, respectively.

4. RESULTS

4.1. Decomposition of antibiotics by gamma irradiation

The concentrations of the target compounds were exponentially decomposed with increasing irradiation doses (Fig. 1). More than 95% of target compounds were radiolytically decomposed at a dose of 1.5 kGy. The degradation kinetics followed the first-order decay equation:

$$\frac{dC}{dD} = -k_r \cdot C \Leftrightarrow C_D = C_0 \cdot e^{-k_r D} \quad (3)$$

where C_D is the concentration of the target compounds with the absorbed dose (D) of irradiation, C_0 is the initial concentration of the target compounds and k_r is the dose constant. The rate constants for LMC, SMX, and TCN were 4.28, 1.83, and 1.73 kGy^{-1} , respectively. LMC showed the highest rate constant of all compounds, and SMX and TCN showed similar values. However, the target compounds were not completely mineralized, revealed by the identical TOC level in the irradiated samples (Fig. 1). The radiolysis efficiency (G-value) [13] was 0.185 (LMC), 0.772 (SMX), and 0.435 (TCN) under 0.4 kGy irradiation, but decreased with an increase in the absorbed dose.

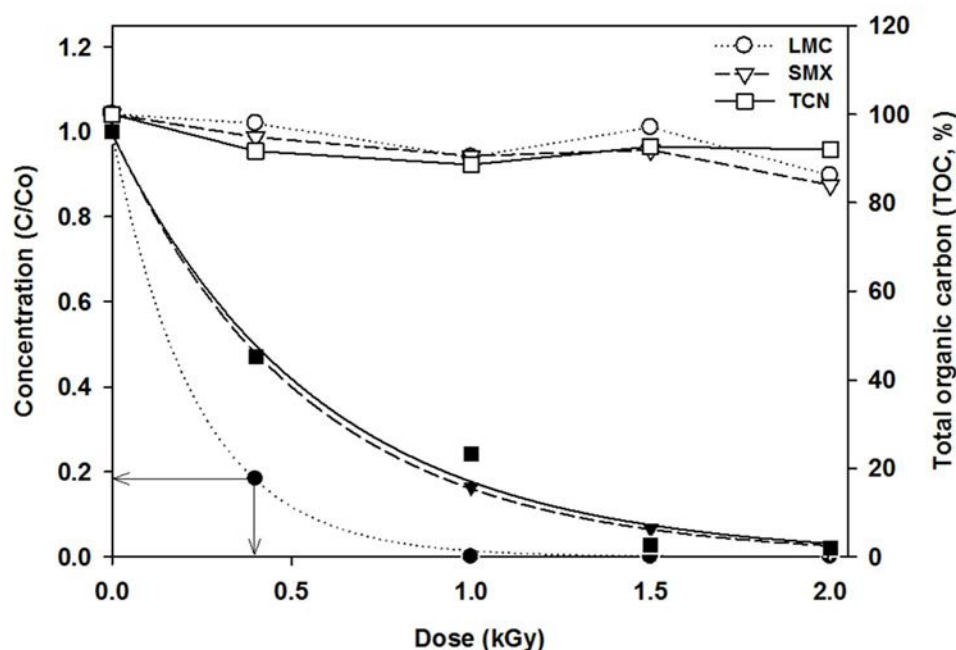

FIG. 1. Decomposition of lincomycin (LMC, \circ), sulfamethoxazole (SMX, ∇) and tetracycline (TCN, \square) and the change of total organic carbon (TOC) by ionizing radiation. Closed symbols refer to relative residual concentrations measured by HPLC and open symbols refer to the changes in the percentage of TOC. The initial concentration (C_0) was 17 mg/L.

It is known that water radiolysis by ionizing radiation generates oxidizing agents including primary reactive radicals such as hydroxyl radicals ($\cdot\text{OH}$), hydrogen radicals ($\cdot\text{H}$), and hydrated electrons (e_{aq}^-) and molecular products such as hydrogen (H_2) and hydrogen peroxide (H_2O_2) [18]. These primary species induce the decomposition of the target compounds, leading to subsequent pathways including hydroxylation and ring fragmentation [19].

Among these, the degradation might be dominated by the hydroxyl radical, which is well documented in the study of Zeng and Arnold [20]. They determined the role of various photochemically produced reactive intermediates (PPRIs) and their contribution to the overall pesticide photolysis. As a result, the highest rate constant of hydroxyl radical was observed, showing $2.1\text{--}9.0 \times 10^9 \text{ M}^{-1} \text{ s}^{-1}$, while the rate constant of other reactive species were relatively low ($1.1 \times 10^6\text{--}7.5 \times 10^7 \text{ M}^{-1} \text{ s}^{-1}$ for carbonate radical, $1.7 \times 10^5\text{--}3.1 \times 10^7 \text{ M}^{-1} \text{ s}^{-1}$ for singlet oxygen). The hydroxyl radicals could react with target compounds and induce bond cleavage or replacement of functional groups. In case of sulfamethoxazole, it was suggested that the hydroxyl radicals may react with sulfanilic acid by addition to the benzene ring, resulting in the predominant formation of OH adducts. This compound may lead to the transformation into cation radicals by dehydroxylation [21, 22]. Electrophilic hydroxyl radical also added to the aromatic ring of tetracycline and formed a resonance stabilized carbon-centered radical and resulted in the formation of the phenolic products [23]. The lower mineralization, revealed by the unchanged TOC level, indicates that the production of intermediates which were not further degraded under the identical condition.

Although the matrix effect was not considered in the present study, the degradation efficiency could also be influenced by the components in matrix. The variation of removal efficiency in pure water, surface water, subterranean water, and wastewater was observed [24]. As a result, the degradation rate in pure water was slightly higher than other types of water, corresponded to the concentration of dissolved organic matter in samples. The variation in the removal rate is due to the different contents of hydroxyl radical scavengers in water samples such as carbonate and bicarbonates.

4.2. The change of biodegradability of antibiotics

The biodegradability of antibiotics after gamma radiation treatment was assessed by monitoring the change in biological oxygen demand (BOD). BOD is known to be a good parameter for aerobic biodegradation, which indicates the degradation of organic substances in an aqueous solution [16]. As a control test, abiotic (no microorganism inoculum and without radiation treatment) and biotic degradation (microorganism inoculum and without radiation treatment) were compared to distinguish the elimination by the abiotic and biotic mechanisms. During the test period of 28 days, 44.1% (LMC), 64.4% (SMX), and 59.6% (TCN) of each target compound were reduced in the biotic controls, whereas 31.1% (LMC), 34.4% (SMX), and 21.1% (TCN) were degraded by the abiotic mechanism (e.g. hydrolysis), as shown in the abiotic controls (Fig. 2). The differences between the abiotic and biotic controls for the degradation of the antibiotic compounds indicate the microbial reduction of the antibiotic compounds during the test period of 28 days. The BOD of the abiotic control ranged from 5 to 10 mg/L for SMX and TCN, and the BOD of LMC was close to zero. The results indicated that TCN was more resistant to abiotic hydrolysis than the other targets, whereas the LMC was resistant to biodegradation.

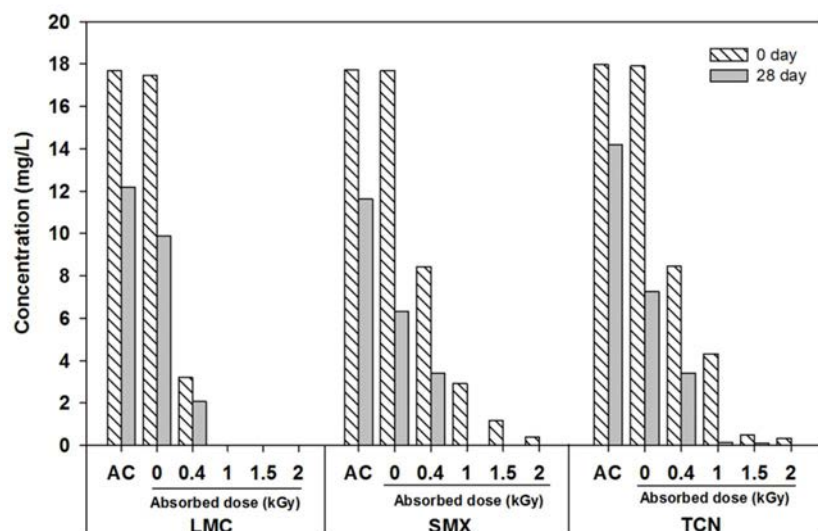

FIG. 2. The remaining concentration of gamma irradiated target compounds before (0 day) and after the biodegradation test (28 day).

However, the BOD of the gamma radiation-treated antibiotics was significantly increased in comparison with the abiotic and biotic control. During the experimental period, the biodegradability compared to the biotic control was gradually increased and finally reached 18.89%, 28.33%, and

36.62% for LMC, SMX, and TCN, respectively (Fig. 3). The results indicate that gamma irradiation converts some portion of non-biodegradable antibiotics into biodegradable by-products. The target compounds were further reduced when preceded by gamma irradiation, reaching 99.2–100% under 1.0 kGy of absorbance dose, which means that the prior treatment followed by biodegradation can induce the complete mineralization of recalcitrant compound [25]. Biodegradability of gamma-irradiated TCN was the most enhanced, and LMC was less than the others, indicating that the by-products of gamma-irradiated LMC were still resistant to biodegradation.

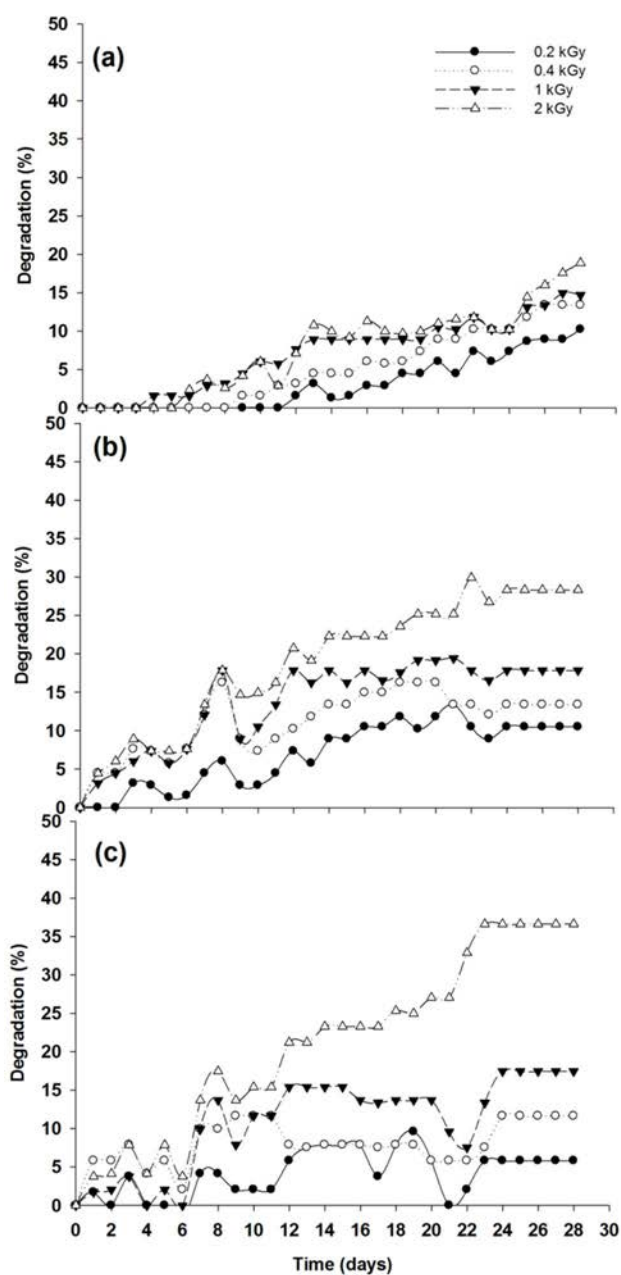

FIG. 3. Normalized biodegradability of lincomycin (a), sulfamethoxazole (b), and tetracycline (c) after gamma irradiation in a closed bottle test (CBT).

5. SUMMARY

In summary, the degradation of the target antibiotics by hydrolysis, biodegradation, and gamma irradiation showed a compound-dependent manner. LMC was the most resistant to biodegradation, but efficiently degraded by gamma irradiation. TCN, showing higher resistance to hydrolysis than other compounds, was efficiently eliminated by biodegradation. Moreover, the biodegradability of all target compounds was enhanced by 19–37% after gamma irradiation, indicating that the radiolysis of antibiotic compounds might potentially generate biodegradable by-products. Therefore, the degradation of non-biodegradable antibiotics can be accomplished by ionizing radiation followed by biodegradation. The enhanced biodegradability of recalcitrant water pollutants can support ionizing radiation

technology as a good alternative to conventional treatment system for recalcitrant water pollutants such as pharmaceuticals. Further study is needed to identify by-products of non-degradable antibiotic compounds using ionizing radiation.

ACKNOWLEDGEMENT

This study was supported by a Nuclear & Development Program of National Research Foundation of Korea (NRF), grant funded by the Ministry of Science, ICT and Future Planning(MSIP) of Republic of Korea.

REFERENCES

- [1] SARMAH, A.K., MEYER, M.T., BOXALL, A.B.A., A global perspective on the use, sales, exposure pathways, occurrence, fate and effects of veterinary antibiotics (VAs) in the environment. *Chemosphere*, **65**, (2006) 725–759.
- [2] WISE, R., Antimicrobial resistance: priorities for action. *J. Antimicrob. Chemother.*, **49**, (2002) 585–586.
- [3] KIM, S.D., CHO, J., KIM, I.S., VANDERFORD, B.J., SNYDER, S.A., Occurrence and removal of pharmaceuticals and endocrine disruptors in South Korean surface, drinking, and waste waters. *Water Res.*, **41**, (2007) 1013–1021.
- [4] KOLPIN, D.W., FURLONG, E.T., MEYER, M.T., THURMAN, E.M., ZAUGG, S.D., BARBER, L.B., BUXTON, H.T., Pharmaceuticals, Hormones, and Other Organic Wastewater Contaminants in U.S. Streams, 1999–2000: A National Reconnaissance. *Environ. Sci. Technol.*, **36**, (2002) 1202–1211.
- [5] TERNES, T.A., Occurrence of drugs in German sewage treatment plants and rivers. *Water Res.*, **32**, (1998) 3245–3260.
- [6] KARTHIKEYAN, K.G., MEYER, M.T., Occurrence of antibiotics in wastewater treatment facilities in Wisconsin, USA. *Sci. Total Environ.*, **361**, (2006) 196–207.
- [7] BOXALL, A.B.A., FOGG, L.A., KAY, P., BLACKWEL, P. A., PEMBERTON, E. J., CROXFORD, A., Prioritisation of veterinary medicines in the UK environment. *Toxicol. Lett.*, **142**, (2003) 207–218.
- [8] BESSE, J.-P., GARRIC, J., Human pharmaceuticals in surface waters: Implementation of a prioritization methodology and application to the French situation. *Toxicol. Lett.*, **176**, (2008) 104–123.
- [9] ANDREOZZI, R., RAFFAELE, M., NICKLAS, P., Pharmaceuticals in STP effluents and their solar photodegradation in aquatic environment. *Chemosphere*, **50**, (2003) 1319–1330.
- [10] HEBERER, T., Tracking persistent pharmaceutical residues from municipal sewage to drinking water. *J. Hydrol.*, **266**, (2002) 175–189.
- [11] HIRSCH, R., TERNES, T., HABERER, K., KRATZ, K.-L., Occurrence of antibiotics in the aquatic environment. *Sci. Total Environ.*, **225**, (1999) 109–118.
- [12] BASFAR, A.A., KHAN, H.M., AL-SHAHRANI, A.A., COOPER, W.J., Radiation induced decomposition of methyl tert-butyl ether in water in presence of chloroform: Kinetic modelling. *Water Res.*, **39**, (2005) 2085–2095.
- [13] YU, S., LEE, B., LEE, M., CHO, I.-H., CHANG, S.-W., Decomposition and mineralization of cefaclor by ionizing radiation: Kinetics and effects of the radical scavengers. *Chemosphere*, **71**, (2008) 2106–2112.
- [14] KIM, T.-H., KIM, S.D., KIM, H.Y., LIM, S.J., LEE, M., YU, S., Degradation and toxicity assessment of sulfamethoxazole and chlortetracycline using electron beam, ozone and UV. *J. Hazard. Mater.*, (2012) 227–228, 237–242.
- [15] OECD, OECD guidelines for testing of chemicals, 301A: DOC Die-Away-Test; 301B: CO₂ evolution test; 301C: Modified MITI test; 301D: Closed bottle test; 301E: Modified OECD screening test; 301F: Manometric Respirometry test. (1993) Paris.

- [16] REUSCHENBACH, P., PAGGA, U., STROTMANN, U., A critical comparison of respirometric biodegradation tests based on OECD 301 and related test methods. *Water Res.*, **37**, (2003) 1571–1582.
- [17] STASINAKIS, A.S., PETALAS, A.V., MAMAI, D., THOMAIDIS, N.S., Application of the OECD 301F respirometric test for the biodegradability assessment of various potential endocrine disrupting chemicals. *Bioresour. Technol.*, **99**, (2008) 3458–3467.
- [18] GETOFF, N., Factors influencing the efficiency of radiation-induced degradation of water pollutants. *Radiat. Phys. Chem.*, **65**, (2002) 437–446.
- [19] ZONA, R., SOLAR, S., GEHRINGER, P., Degradation of 2,4-dichlorophenoxyacetic acid by ionizing radiation: influence of oxygen concentration. *Water Res.*, **36** (2002) 1369–1374.
- [20] ZENG, T., ARNOLD, W.A., Pesticide Photolysis in Prairie Potholes: Probing Photosensitized Processes. *Environmental Science & Technology*, **47**, (2013) 6735–6745.
- [21] BEHAR, D., BEHAR, B., Pulse radiolysis studies of aminobenzenesulfonates: formation of cation radicals. *The Journal of Physical Chemistry*, **95**, (1991) 7552–7556.
- [22] MEZYK, S.P., NEUBAUER, T.J., COOPER, W.J., PELLER, J.R., Free-radical-induced oxidative and reductive degradation of sulfa drugs in water: absolute kinetics and efficiencies of hydroxyl radical and hydrated electron reactions. *The Journal of Physical Chemistry A*, **111**, (2007) 9019–9024.
- [23] JEONG, J., SONG, W., COOPER, W.J., JUNG, J., GREAVES, J., Degradation of tetracycline antibiotics: Mechanisms and kinetic studies for advanced oxidation/reduction processes. *Chemosphere*, **78**, (2010) 533–540.
- [24] SÁNCHEZ-POLO, M., LÓPEZ-PENALVER, J., PRADOS-JOYA, G., FERRO-GARCÍA, M.A., RIVERA-UTRILLA, J., Gamma irradiation of pharmaceutical compounds, nitroimidazoles, as a new alternative for water treatment. *Water Res.*, **43**, (2009) 4028–4036.
- [25] BARAN, W., SOCHACKA, J., WARDAS, W., Toxicity and biodegradability of sulfonamides and products of their photocatalytic degradation in aqueous solutions. *Chemosphere*, **65**, (2006) 1295-1299.

RADIATION TREATMENT FOR RECYCLING OF INDUSTRIAL WASTEWATER FOR INDUSTRIAL USAGE- BIOLOGICAL AND IRRADIATION TREATMENT OF MIX INDUSTRIAL WASTEWATER IN FLOOD MITIGATION POND AT PRAI INDUSTRIAL ZONES

BAKAR K.A., SHARIF J., SARALASELAMBAKKANU S., MING T.T., ISNIN N., OSMAN H.N., IASAHHASHIM S.

Malaysian Nuclear Agency (Nuclear Malaysia)
Bangi, 43000 Kajang, Selangor
Malaysia

Abstract

In this study, separate e-Beam and activated sludge process were used to treat real mixed industrial waste water from mitigation pond A. The objective of e-Beam treatment study is to determine effect of sample filtration. The ultrasonic treatment prior to e-Beam was used to characterize the properties of mixed industrial wastewater. While, in activated sludge treatment the objective is to observe the effect of adding wastewater from food industries as carbon source, on the properties of the treated effluent. Results show that sample filtered with 400 um mesh has higher COD and TOC values compared to samples filtered with smaller mesh size. The filtered samples were irradiated and the COD was reduced between 1.41 – 4.87% for mesh size 50 – 400 um. The TOC ranges between 1.02 – 3.02% respectively.

Pre-treatment using ultrasonic for 5, 10 and 15 minutes prior to e-beam irradiation had improved the COD removal between 56.25% and 62.50%. At the mean time the TOC has reduced between 14.18 to 23.73% for every minute of the ultrasonic pre-treatment. By adding food based wastewater to the samples from pond A the COD, BOD₅ and colour had reduced from 100, 150, 50 to 90, 100 and 25 respectively. This was achieved after 9 days of biological treatment.

1. OBJECTIVES

The aim of this study is to reduce the absorbed dose by pre-treatment through screening and ultrasonic radiation before irradiation. The second objective is adding food industrial waste water into mix industrial waste water to reduce hydraulic retention time (HRT) in the biological treatment.

2. INTRODUCTION

Mixed industrial wastewater in holding pond pumping station A at Seberang Perai was derived from the treated effluent from various industries in the vicinity. The main industries that release their treated effluent into the holding pond are textiles, plastic, chemical/fertilizer and oleo chemicals. It's capable to contain up to 1 500m³ per day. The holding pond A is a flood mitigation step in the industrial area and also acts as an immediate receiving water body prior release of the effluent into the sea. Effluent in the pond A was not entitled with any type of treatment and the quality of wastewater differs every now and then. Samples used in this study were collected from dry seasons.

Numerous research activities on radiation application for wastewater treatment have been done especially on textiles industrial wastewater [1, 2]. Gamma irradiation for sewage treatment was also studied by several researchers [3, 4]. Degradation mechanism is mainly

due to oxidation and reduction of pollutant by radicals produced by radiolysis of water when electron beam was subjected to water.

Ultrasonic radiation is also considered as a new method in wastewater treatment. A lot of studies investigated the process feasibility with synthetic aqueous solution containing model pollutant [5, 6] and some investigator works with real wastewater [7]. In general, ultrasonic degradation of organic pollutant takes place via two pathways, i.e., homolytic bond breaking and reaction with radicals [8, 9]. Ultrasonic irradiation provokes the generation of .OH through thermal dissociation of water, and the reactions for .OH generation and depletion under ultrasonic irradiation are given in reaction (1)–(4) [10] as follows:

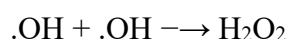
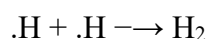
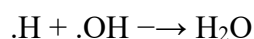
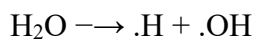

In this study, electron beam radiation was applied to treat real mixed effluent industrial wastewater. For the first batch irradiation, wastewater was filtered with wire mesh of difference sizes to study how particle size presence in wastewater influence the subsequent irradiation. In the second batch of irradiation, ultrasonic treatment was used to treat samples for different period of time prior to electron beam treatment to study its effect on the quality of the irradiated wastewater.

Mixed industrial wastewater was also treated with activated sludge process. This system consists of three basic components, namely:

- (1) Reactor tank with microorganisms responsible for treatment (kept suspended and aerated);
- (2) Solid liquid separation, clarifier tank; and
- (3) Recycle system to return the sludge from clarifier back to the reactor.

3. MATERIALS AND METHOD

3.1. Sample preparation

3.1.1. Irradiation Treatment

Sampling for mixed industrial wastewater been carried out at centre pump house A, during dry season whereby the initial COD of collected samples was about the range of 130–380mg/l. The samples were divided into two portions. The first portion is used to study the effect of particle size where the water samples were filtered using different size mesh i.e. 400, 300, 250 and 50 um. General procedure is shown in Fig. 1.

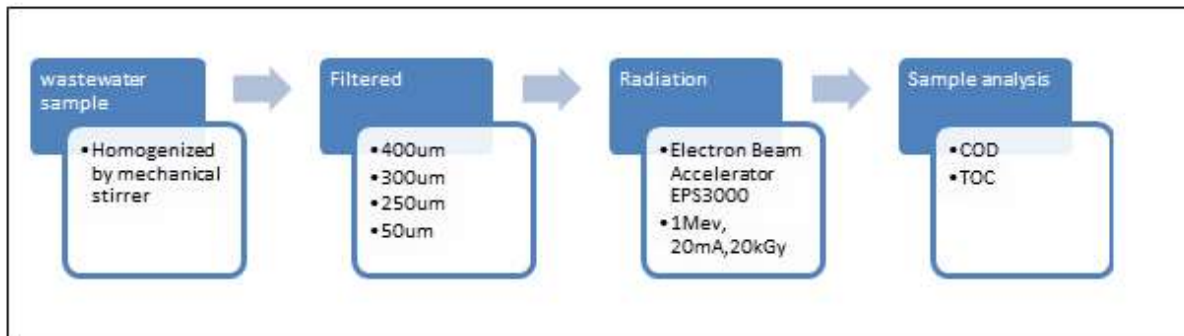

FIG. 1. Experiment setup for particle study.

The second portion was treated with ultrasonic process prior to irradiation for period of 5, 10, 15 minutes (Fig. 2).

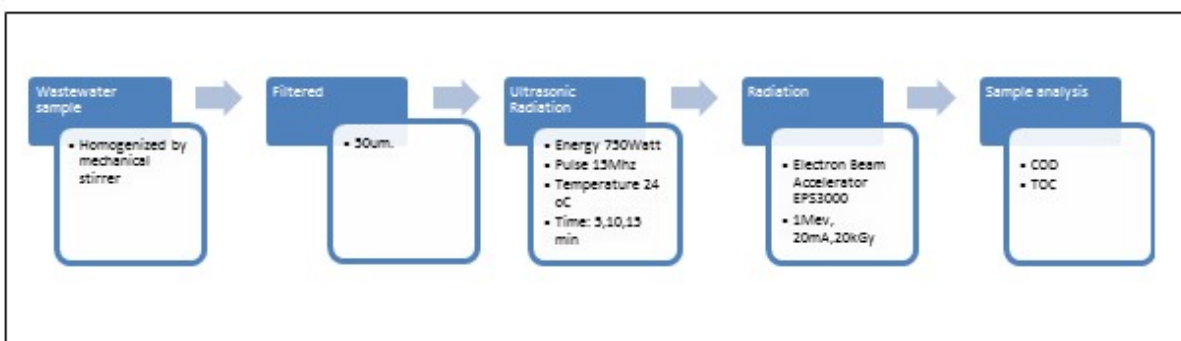

FIG. 2. Experiment procedure for study of ultrasonic pre-treatment.

3.1.2. Biological Treatment

Mixed industrial wastewater was collected from the centre pump house A, during rainy season and the initial COD of the sample was about 400–450mg/l. After screening for solid materials, the pH of the water samples been adjusted to 6.5 to 8.5 as microbes were unable to survive in too acidic or basic medium. Finally, the samples were filled in the biological treatment reaction tank.

3.2. Radiation Treatment

The trays filled with wastewater samples were placed on trolley and transported into radiation chamber by conveyor system. Each tray consists of 800ml of samples with water layer thickness less than 6mm. EPS3000 electron beam machine was used to irradiate the wastewater samples by batch. The beam energy was set at 1Mev and beam current at 20mA while the calculated dose used for the entire irradiation session was only 20kGy.

3.3. Biological Treatment

Lab scale activated sludge system used as biological treatment was made from acryl. It consists three tanks namely equalization tank (10L), aeration tank (4L) and clarifier (4L). Peristaltic pump is used to transfer the wastewater fed into aeration tank to the clarifier. In order to maintain dissolved oxygen (DO) concentration above 2 mg/l in the aeration tank,

water was aerated with diffusers which connected to a small aquarium pump. Daily monitoring of dissolved oxygen by using DO meter in aeration tank was performed. To ensure the biological system works, parameter such as pH and liquid suspended solid was in control. To learn the effect of addition of effluent from food based industries into mixed effluent from pond A on the biological treatment, two treatment system was conducted in parallel, the first consisting a mixed effluent from pond A, the second a mix of effluent from pond A and effluent from food base industries with the ratio of 1:1. The main purpose of this study is to learn the effectiveness of degradation of pollutants in mixed industrial wastewater in the presence of effluent from food based industrial wastewater in biological system.

All the connections were made with silicon tubes. The reactor starts operation at MLVSS concentrations of 3500 mg/l at 48h HRT. In order to maintain the MLVSS concentration, the sludge settled in the clarifier was removed manually using pipettes. The dissolved oxygen was monitored daily by a DO meter in the aeration tank. Parameters such as pH, and mixed liquor suspended solid were controlled in this system to ensure efficiency of the system. The operation of the biological reactor was continuous in order to achieve steady state condition. The lab scale biological treatment is shown in Fig. 3.

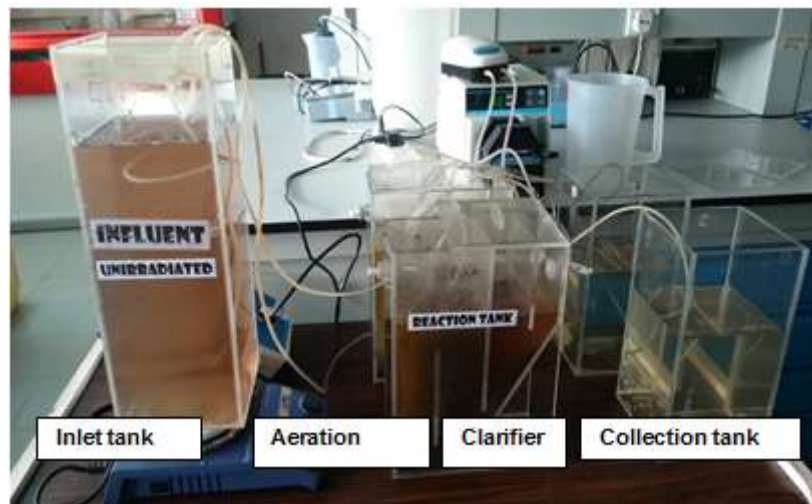

FIG. 3. The activated sludge process consists of Inlet tank, aeration tank, and clarifier and collection tank.

3.3.1. Preparation of acclimatized aerobic culture for MLVSS set-up

Return activated sludge (RAS) was collected from EIMAS activated sludge process in bio treatment plant. This plant was responsible to treat the wastewater from food industry. Collected RAS was mixed with industrial wastewater from pond A and fed with 1% (w/v) glucose media in 5L glass beaker. Air was continuously purged through the diffuser into the beaker. The process was continuously operating for 2 weeks in order to produce acclimatized aerobic culture. At the end of process, the acclimatized aerobic culture was left for 1 hour to allow the biomass to reconcile. Designed volume of this biomass then transferred into aeration tank to start the experiment at required MLVSS 3500mg/l concentration)

3.4. Analysis

Samples were analysed before and after treatment. COD is equivalent to the amount of oxygen required to chemically oxidize the organic matter present in wastewater. To determine

the COD, sample initially digested using dichromate (HR range plus) in Hach reactor while for TOC sample was digested using Low Range TOC reagent. COD and TOC and colour value was determined by Hach DR 5000 spectrophotometer.

4. RESULT AND DISCUSSION

4.1. Screening pre-treatment prior irradiation

Fig. 4 indicated that the COD is lower i.e. 221.25 mg/l, for sample that was filtered using 50 um mesh compared to 264.51 mg/l when using 450 um mesh.

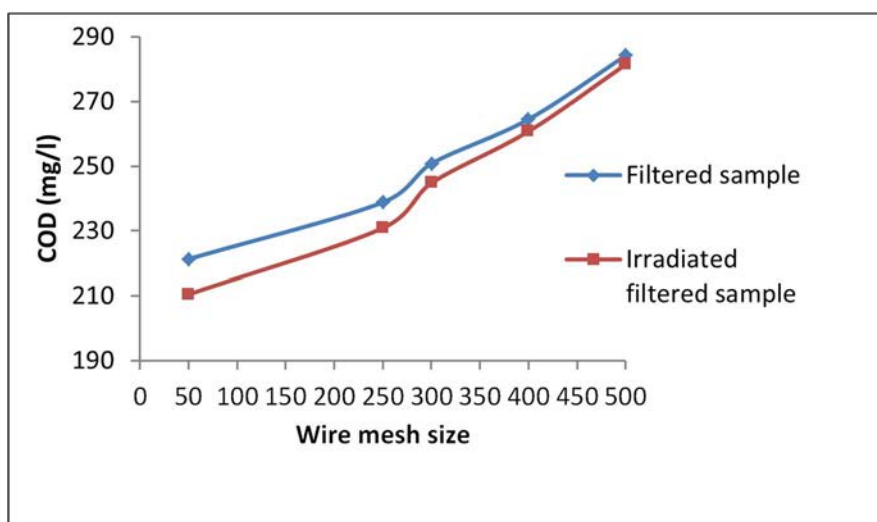

FIG. 4. Effect of particle size on COD

This trend is also similar for TOC where the values are 26.46mg/l and 34.21 mg/l respectively as shown in Fig. 5. This may be caused by removal of solid organic pollutants which is better by using smaller sized mesh.

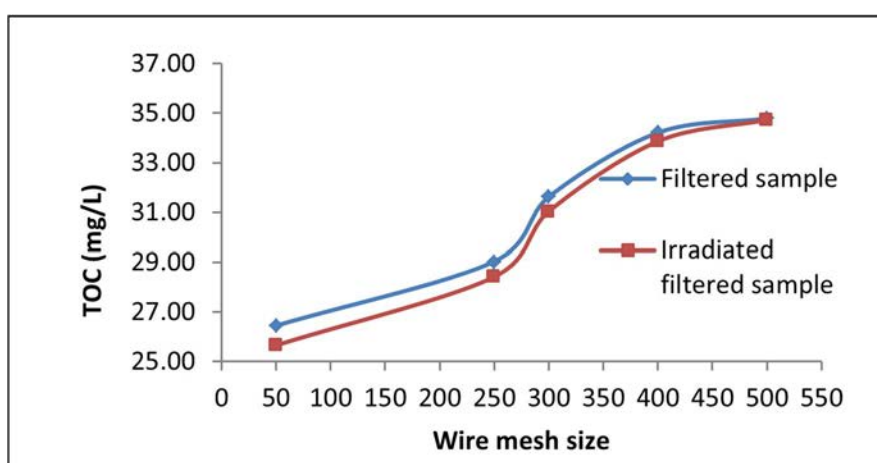

FIG. 5. Effect of particle size on TOC

After undergoing pre-treatment filtration through wire mesh size (50 250 300 and 400 um) and later, e-beam treatment, the results presented in Fig. 6 demonstrates that the removal

percentage of COD is in between 1.41%–4.87%. While TOC removal was in the range 1.02%–3.02%.

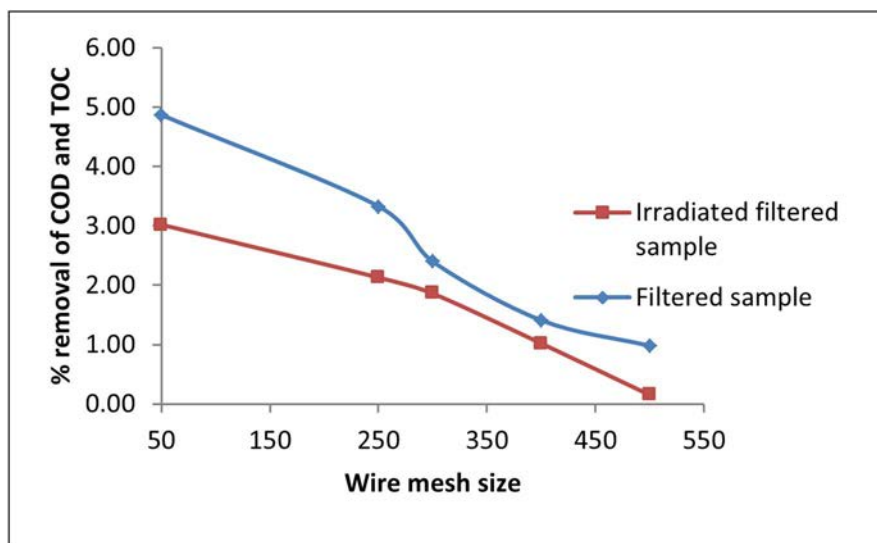

FIG. 6. % removal of COD and TOC.

4.2. Ultrasonic pre-treatment prior irradiation

4.2.1. Effect of irradiation on COD and TOC

The COD and TOC values had decreased when the ultrasonic treatment was prolonged as shown in Fig. 7 and 12.8.

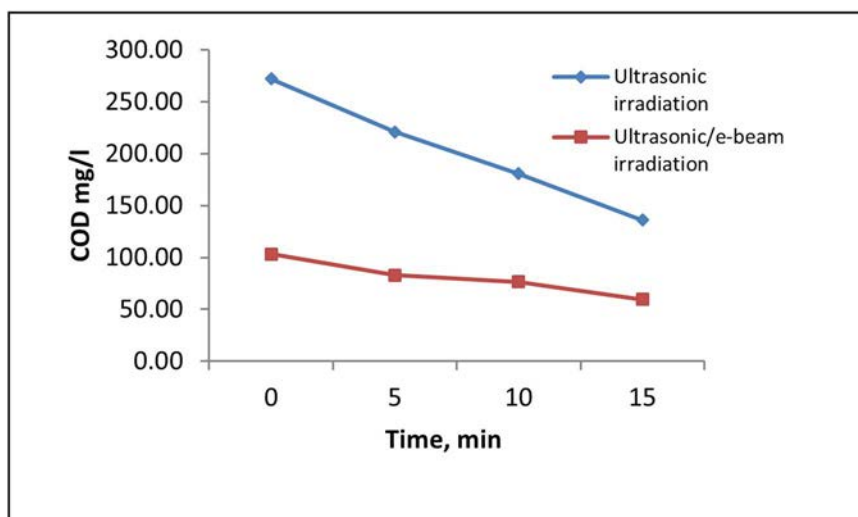

FIG. 7. Effect sonication time on COD.

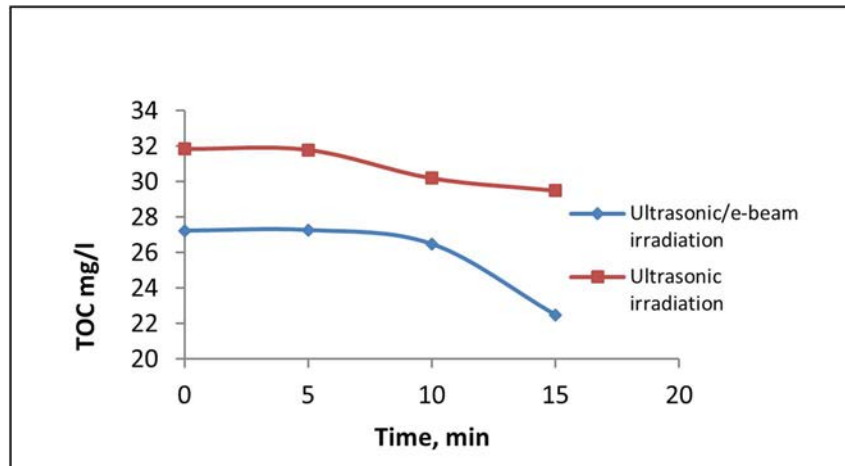

FIG. 8. Effect sonication time on TOC.

The ultrasonic process involves the formation of $\text{OH}\cdot$ as oxidative radicals, which are very reactive but non selective oxidant and H_2O_2 are also formed [11]. Hydrogen peroxide results from the reaction of $\text{OH}\cdot$ and $\text{HOO}\cdot$ in the liquid phase. Degradation of pollutant on the other hand, was due to the oxidation from OH and H_2O_2 . Within the 15 minutes of treatment, more OH and H_2O_2 was formed and causing the COD and TOC to reduce further compared to 5 and 10 minutes of treatment.

After undergoing pre-treatment (5, 10 and 15 minutes) and later, e-beam treatment, the results presented in Fig. 6 demonstrates that the removal percentage of COD is in between 56.25%–62.50%. While TOC removal was in the range 12.25%–23.73%.

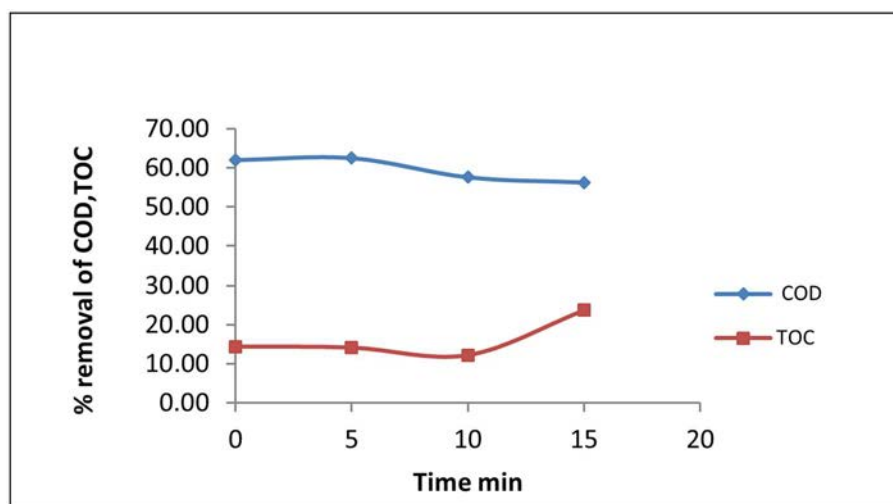

FIG. 9. Effect of irradiation on removal % of COD and TOC.

4.3. Biological Treatment

Initial characterization of the wastewater collected from the industries being carried out by the measurement COD, biological oxygen demand (BOD) and colour. Typical characteristics of both wastewaters are shown in Table 1.

TABLE. 1: CHARACTERISTICS OF TEXTILE AND FOOD INDUSTRY WASTEWATER

Samples	COD(mg/l)	BOD(mg/l)	Colour(ADMI)	Phosporus(mg/l)	Nitrite(mg/l)
Mix Industrial wastewater from Pond A	130–380	50–126	30–50	7.55	0.03
Food Industrial wastewater	500–380	160–220	50–80	28.55	0.15

The efficiency of the treatment process is normally based COD reduction as a percentage of the organic matter purified during the treatment. It measures the amount of oxygen that is consumed by the water in the decomposition of organic matter. Fig. 10 shown that COD of both samples reduce after biological treatment and the percentage of reduction are roughly 20.11% for wastewater from Pond A and 90.95% for mixture of wastewater from pond A and food based industrial wastewater.

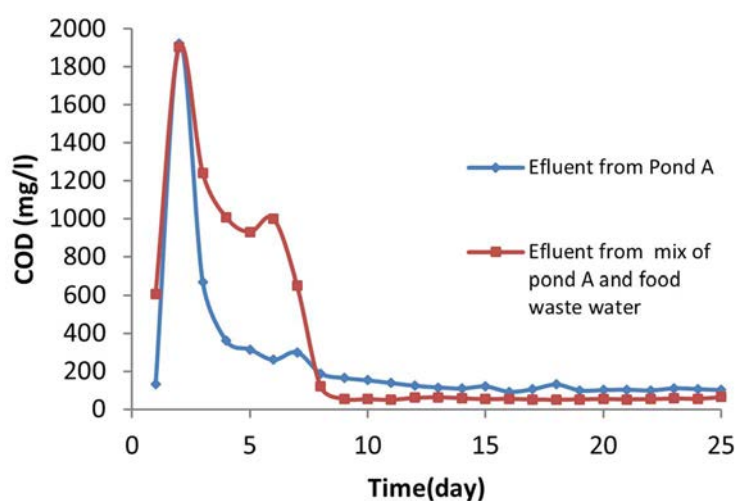

FIG. 10. Degradation of organic pollutant after biological treatment.

The COD was significantly reduced when wastewater from food industry was added. The additional wastewater contributed carbon source to the microbes that caused degradation of organic pollutants. Food wastewater also contained nutrients such as phosphorus and nitrates compared to the mixed wastewater from pond A as shown in Table 1. The addition had also speed up the stabilization of the treatment process from 14 to 9 days.

Biochemical oxygen demand (BOD₅) is an analysis to determine the uptake rate of dissolved oxygen by the biological organisms in a body of water. After biological treatment the BOD₅ of wastewater from Pond A reduced by 15.29% while for mixture of wastewater from pond A and food based industrial wastewater, BOD₅ reduce by 89.04%. High BOD₅ value can be interpreted as high concentration of oxidizable materials present in a water sample. Therefore, the reduction of BOD₅ implies that oxidizable materials found in the sample have been reduced. This reduction can be expected and is in agreement with the results obtained for COD as mentioned above. The BOD₅ results for both batches are shown in Fig. 11

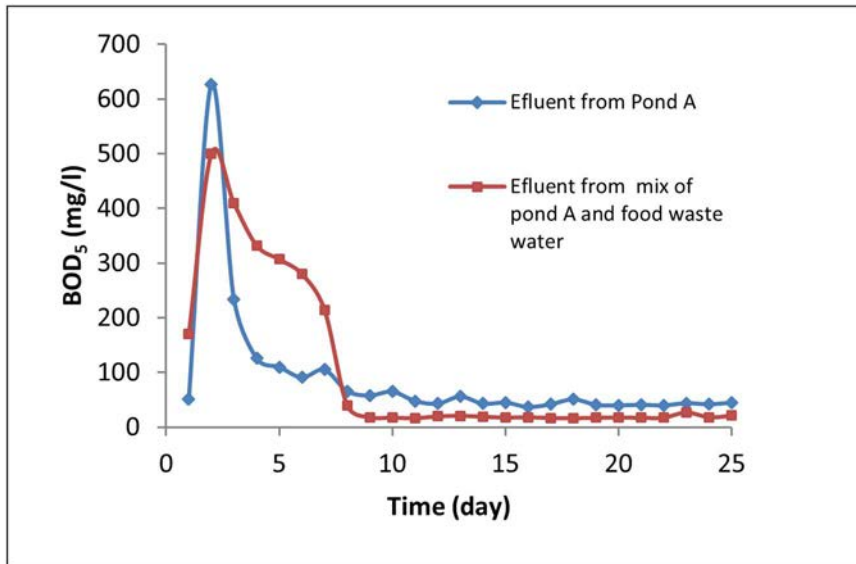

FIG. 11. BOD₅ of both sample after treated in Biological treatment.

Better reduction on COD and BOD₅ in the addition of food industrial waste water may be because the food wastewater had provided more carbon source for the microorganism which is responsible to degrade the organic pollutants. Microorganisms require energy to maintain its functions. Food base wastewater as carbon source contain high concentrations food supply that can be utilized to generate energy required to serve this function [12].

Colour in both samples shows reduction trend when it is subjected to biological treatment as shown in Fig. 12. The colour of wastewater from Pond A reduced by 9.28% and 47.46% for the wastewater from pond A mixed with food based industrial wastewater. Colour change was difficult to observe since this study did not identify the actual composition of both wastewaters.

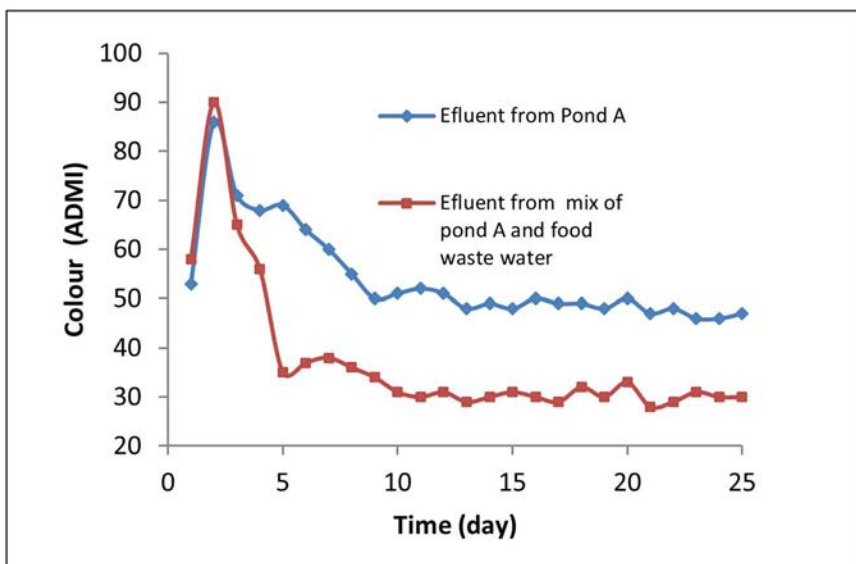

FIG. 12. Colour of both sample after treated in Biological treatment.

5. SUMMARY

This preliminary study shows that it is possible to reduce the irradiation dose by implementing pre-treatment process such as filtering and ultrasonic treatment, as such had significantly reduced the COD and TOC values.

The effluent containing food wastewater had more effectively improved all parameters compared to the original effluent.

REFERENCES

- [1] BUMSOO, H., JAEIN, K., JINKYU, K., YURI, K., WOOHO, C., MAKAROV, I.E., PONOMAREV, A.V, PIKAEV, A.K., Combined electron-beam and biological treatment of dyeing complex wastewater. Pilot plant experiments” *Radiation Physics and Chemistry* **64**. (2002) 53–59.
- [2] KIM, T.H., LIM, J.K. LEE, M.J., ` Biodegradability enhancement of textile wastewater by electron beam irradiation., *Radiation Physics and Chemistry* **76** (2007) 1037–1041.
- [3] GRAINO, J.G., “Radiation technology for sewage sludge treatment: The Argentina project”, IAEA-TECDOC-1225 **163** (2001).
- [4] SHAH, M.R., ,LAVALE, D.S., RAWAT, K.P., BENNY, P.G, SHARMA, A.K., DEY, G.R., BHAVE V., `Radiation on Hygienization of Raw Sewage Sludge””, IAEA-TECDOC-1225. **147** (2001)
- [5] KEJIA, Z, NAIYUN, G., YANG, D., TSAIR, F.L., YAN, M., LEI, L., MINGHAO, S., ‘Degradation of bisphenol-A using ultrasonic irradiation assisted by low-concentration hydrogen peroxide’, *Journal of Environmental Sciences* **23(1)** (2011), 31–36.
- [6] ME´NDEZ-ARRIAGAD, F., TORRES-PALMAA, R.A., PE´TRIERA, C., ESPLUGASD, S., GIMENEZD, J., PULGARINC, C.,`Ultrasonic treatment of water contaminated with ibuprofen. ,*water r e s e a r c h* **42** (2008) 4243–4248
- [7] KATI, E., HEIKKI, S., TONNI, A.K, MIKA, E.T. SILLANPÄÄ `Removal of recalcitrant contaminants from bleaching effluents in pulp and paper mills using ultrasonic irradiation and Fenton-like oxidation, electrochemical, treatment, and/or chemical precipitation: A comparative study, *Desalination* **255** (2010) 179–187.
- [8] GUO, Z.B., FENG, R., ‘Ultrasonic irradiation-induced degradation of low-concentration bisphenol A in aqueous solution’. *Journal of Hazardous Materials*, **163(2–3)** (2009) 855–860.
- [9] REHOREK, A., TAUBER, M., GUBITZ, G., Application of power ultrasound for azo dye degradation. *UltrasonicsSonochemistry*,**11(3–4)** (2004) 177–182
- [10] NIE, M., WANG, Q., QIU, G.H., Enhancement of ultrasonically initiated emulsion polymerization rate using aliphatic alcohols as hydroxyl radical scavengers. *UltrasonicsSonochemistry*, **15(3)** (2008) 222–226
- [11] GONZE, E., COMMENGES, E., GONTHIER Y., BERNIS, A., ‘High frequency ultrasound as a pre- or a post-oxidation for paper mill wastewaters and landfill leachate treatment’ *Chemical Engineering Journal* **93**. (2003) 215–225.
- [12] NESTER, E.W., ANDERSON, D.G., ROBERT, C.E., PEARSALL, N.N., NESTER, M.T., *Microbiology-A Human Perspective*.3th. Ed. Mcgraw-Hill Companies, Inc (2001)
- [13] GONZE E., FOUREL, L., GONTHIER, Y., BOLDO, P., BERNIS, A., `Wastewater pretreatment with ultrasonic irradiation to reduce toxicity’ *Chemical Engineering Journal* **73** (1999) 93–100.

RESEARCH LABORATORY AND FEASIBILITY STUDY FOR INDUSTRIAL WASTEWATER EFFLUENTS TREATMENT BY RADIATION

Z. ZIMEK, K. ROMAN, S. DŁUGOŃ, W. GŁUSZEWSKI, M. SUDLITZ.

Centre for Radiation Research and Technology, Institute of Nuclear Chemistry and Technology, Warsaw
Poland

Abstract

Mechanism of sedimentation process of nonorganic pollutants initiated by ionizing radiation was confirmed experimentally. It was found that irradiation considerably affects wastewater filterability, bound-water content, and the enhancement of agglomeration of suspended particles. Evaluation from technical and economical point of view of this specific radiation technology was performed towards feasibility study preparation for industrial wastewater facility. Particularly electron accelerators performances were investigated to evaluate their disadvantages and advantages to make characteristic a final decision regarding accelerator selection. The optimization beam utilization coefficient was performed by computer simulation based on Monte Carlo method to increase the facility throughput. Cost analysis of industrial wastewater effluents treatment by radiation was performed to establish basic parameters and facility cost-effectiveness assumptions on the base of accelerator performances, required dose and established electron beam utilization coefficient. Accelerator (electron energy 1MeV, beam power 400 kW) cost including spare parts, installation and training and the cost related to the building construction, irradiation chamber and other spending were taking into account. The total investment cost was estimated as 4.2 M\$. The exploitation cost was evaluated taking into account variable and fixed costs. When bank credit is adopted (8% for 20 years) and electricity cost 0.05 \$/kWh is applied the annual exploitation cost amounts 1.1 M\$. Estimated costs for wastewater electron beam treatment process in above conditions was obtained as 0.40 \$/m³. To justify process implementation the dose rate should be properly decreased by process parameters optimization (temperature, additives) and value of by-product should be taken into economic evaluation.

1. OBJECTIVE OF THE STUDY

The objective of the study was to explore the use of radiation processing techniques for treatment of industrial wastewater generated from an industrial Soda manufacturing industry. The study focused on determination of the productivity of the irradiation process, selection of accelerator and technology suitable for the treatment, concept of the installation devoted to the radiation processing of the industrial wastewater treatment, description of basic parameters of biological shields to be applied in the accelerator building, estimation of project costs.

2. INTRODUCTION

Industrial wastewater is being unwilling by product of certain industrial process. Sometime it can be derived as usable product after additional treatment by radiation. Radiation processing has been found to be effective in decomposition of toxic substances, and an improvement in some its physicochemical properties and may offer unique possibility for wastes recycling, when common processes are too expensive or not offering required efficiency.

Industrial waste generated during soda (NaHCO₃) fabrication based on Solvay process can be divided on nonorganic solid particles and liquid phase. It was recognized that in common

process conditions solid particles amounts up to 200 kg per 1 t of suspension. The solid particles consists of calcium carbonate (CaCO_3) 70% and silica 30%. Liquid phase is dominated by NaCl presence (300 g/l) with some quantities of other compounds like KCl, CaCl_2 , CaSO_4 , mgCl_2 , $\text{Ca}(\text{HCO}_3)_2$ with concentration in the range of 0.3 – 3.0 g/l. Sediment separation with limited chloride content (<0.5% of dry mass) could be the main task of treatment process. Liquid phase will be reuse in industrial process after conventional treatment. It was found that the sedimentation capabilities of sediments had been significantly improved by non-selective radiation induced processes based on free radical reactions and surface effects in adsorption on solids and systematic interaction of sedimentation and electrical field.

Liquid wastewater irradiators have been designed to operate in batch or continuous flow mode with the use of pipes and pumping systems. Present electron accelerators capabilities are well suited for continuous treatment of the wastes in liquid form in appropriate thickness at a rate defined by electron beam power. Low energy high power accelerators which are used for environment protection are accommodated to irradiation with relatively low liquid thickness and very high throughput rate. On other hand one side irradiation cannot offer good irradiation homogeneity with sufficient beam utilization and additionally very high speed of flow rate could be difficult technical problem to be solved.

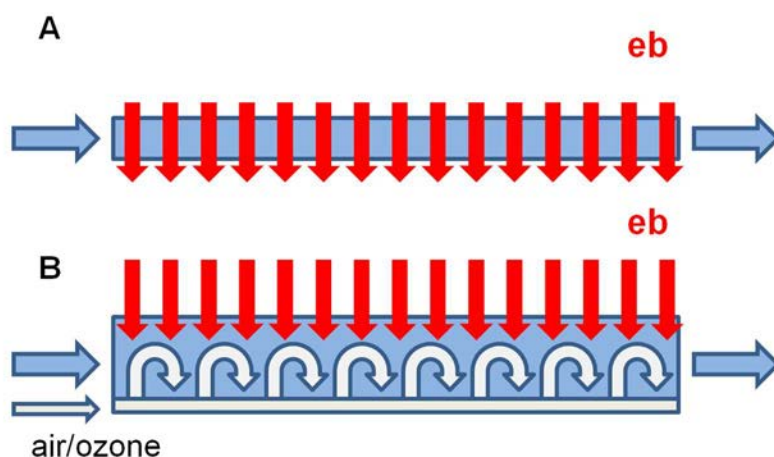

FIG. 1. Configuration of one side wastewater irradiation chamber: A – tray method; B – irradiation combined with air/ozone bubbling process

The homogeneity of one side wastewater irradiation can be slightly improved by mixing or bubbling wastewater stream which is passing irradiation zone (Fig. 1). It should be noticed that 100% of energy transfer efficiency cannot be obtained due to additional beam power losses connected to presence primary (accelerator) and secondary (irradiation chamber) windows, existing air path between accelerator window and wastewater surface and side effects on scanned beam edges.

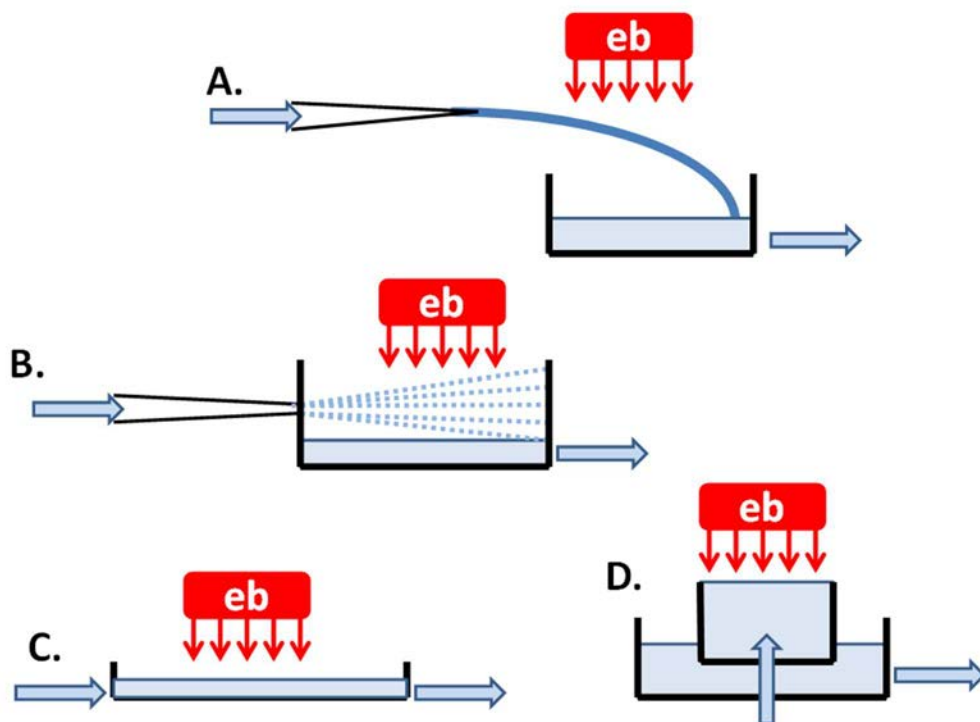

FIG. 2. Different geometry of reactors for wastewater irradiation: A) nozzle injection; B) sprayer; C) tray with air bubbling; D) up-flow system.

Appropriate geometry of irradiated thin wastewater layer should be used due to limited accelerated electrons penetration range (Fig. 2), what was well demonstrated in number of pilot plant facilities [1-5].

The study of wastewater treatment by radiation towards sedimentation processes contribution and physical-chemical separation of highly concentrated nonorganic pollutants deposited in specific industrial waste were investigated in this study, in particular, the ability to reduce the salt content of the waste in manufacturing. This study deals with the concept of installation to be used for industrial wastewater with radiation technology application. The main emphasis was to demonstrate the effectiveness of methods of radiation in sedimentation post-production. The system is expected to be installed at one of selected industrial plant in Poland.

3. EXPERIMENTAL

Laboratory EB facility for study industrial wastewater effluents treatment was designed to study and confirm possible mechanism of the sedimentation process of nonorganic pollutants initiated by ionizing radiation. The density profiles formation in sedimentation of suspensions and chemical destruction caused by electron beam will be studied. Laboratory equipment construction for effective electron beam implementation during radiation treatment process with controlled flow rate for irradiation vessel supply and auxiliary instrumentation was developed towards process parameters optimal selection. Technical and economic aspects for industrial facility type were studied during the study. The experimental program of model installation application is directed towards collection necessary data for justification assumptions of feasibility study and design pilot and industrial facility to perform soda waste treatment in much higher scale. At first it was connected to construction of irradiation vessel

suitable for high capacity process. The confirmation of suitable dose rate level for certain geometry of irradiation process will be important from economical point of view and productivity of the irradiation process. Important for process automatic control will be necessary testing algorithm of computer based control process to obtain optimization technology towards better economy of implemented method or optimization functional parameters of received by product.

4. RESULTS AND DISCUSSION

Wastewater radiation processing was found to be effective in improvement of sedimentation capability of irradiated liquid waste due to changes produced in its physicochemical properties. It was found that irradiation considerably affects wastewater filterability, bound-water content, the enhancement of agglomeration of sludge particles. Dose 2.5 kGy was proposed for initiate radiation processes. The required dose level can be lowered depending on wastewater composition and its temperature. The results under various conditions (Figs. 3–6) led to the conclusion that irradiation of suspension increases both the speed of sedimentation which reduces the final amount of the solid phase. Both are huge serving parameters important from the point of view of technology. Irradiation was performed by electron beam in accelerator facility. It can be easily noticed that the dose 2.5 kGy is optimal for sedimentation process [6].

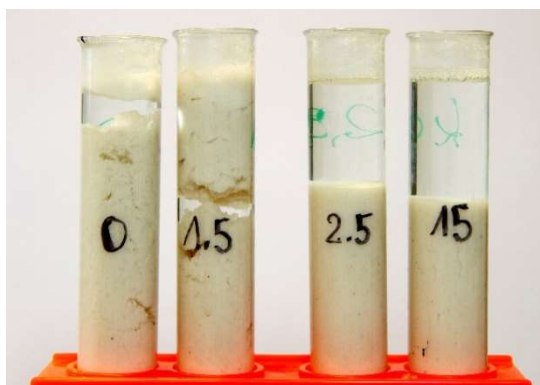

FIG. 3. The impact of radiation on the process of sedimentation. Samples of 3.3 hours. As can be seen, it dramatically increased the amount of sodium chloride recycle to the process (increasing the supernatant solution phase).

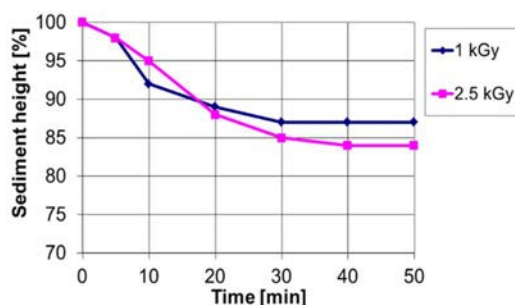

FIG. 4. Formation of layers upon sedimentation time of raw industrial waste for different dose levels.

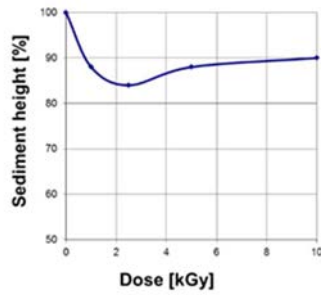

FIG. 5. Formation of sediment layers of raw industrial waste depends on the dose level.



FIG. 6. Formation of layers upon sedimentation of raw industrial waste from brine purification and distillation stages. A) Brine purification products with calcium and magnesium ions, B) wastes from the production of soda.

Based on these laboratory studies, a flow sheet of waste processing plant equipped with electron accelerator, two sedimentation tanks and filter for sediment separation was proposed as shown in Fig. 7.

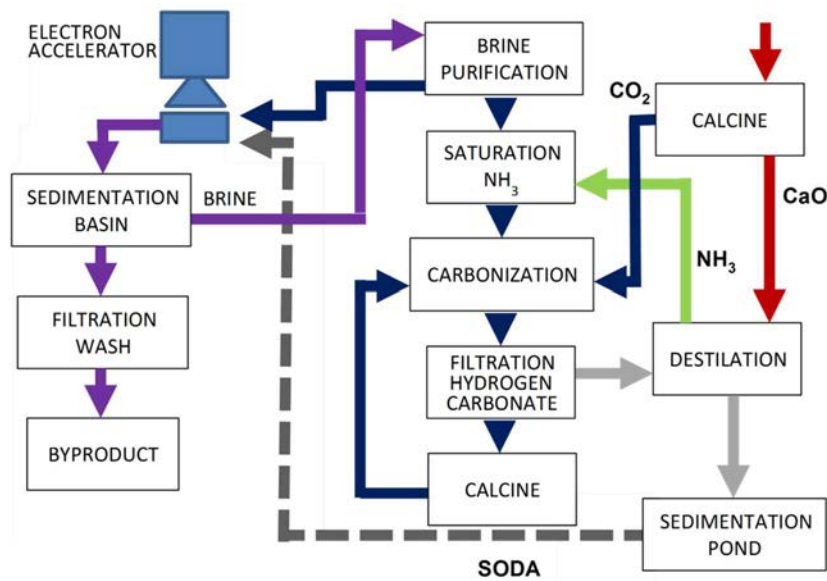

FIG. 7. Flow sheet of the soda production facility equipped with waste processing.

The necessary process water re-circulates in close system equipped with conventional treatment technology. It should be mentioned that coagulating agent application is excluded to avoid distortion of main industrial process. On the other hand separated sediment can be recognized as market product and practically applied as component of agriculture fertilizers or building materials.

The proposed control system of the laboratory EB facility for wastewater treatment and the injection nozzle for irradiation of liquid waste are shown in Fig. 8 and Fig. 9 respectively. The actual laboratory facility equipped with ILU 6electron accelerator used for the study is shown in Fig. 10.

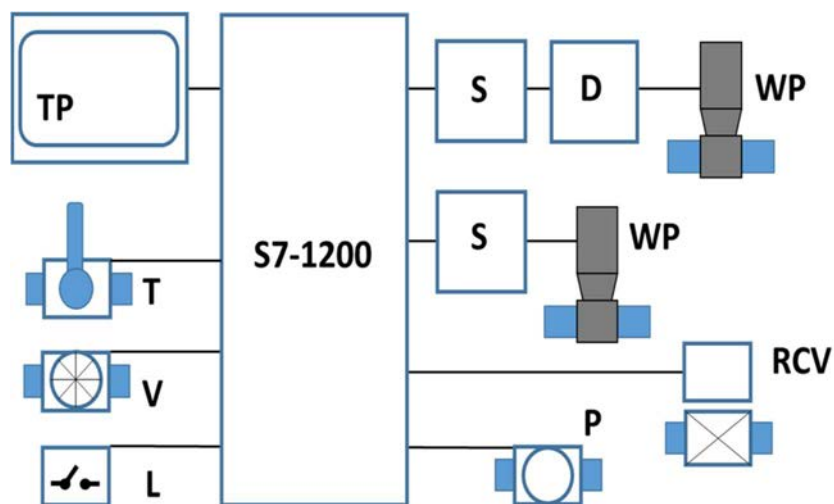

FIG. 8. Control system (CS) of laboratory EB facility for wastewater treatment: TP – touch panel, S7-1200 – microprocessor, T – temperature sensor, V – flow rate sensor, L – level sensor, S – dry run sensor, D – water pump driver, WP – water pump, RCV – remote controlled vale, P – pressure sensor.

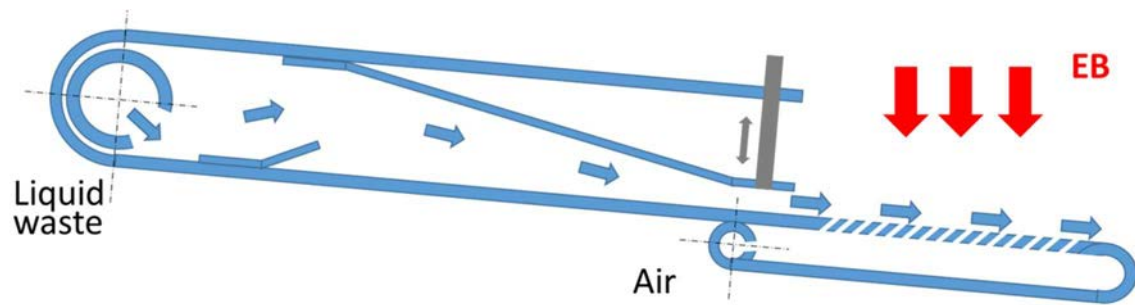

FIG. 9. Principle of injection nozzles of laboratory radiation facility equipped with electron accelerator ILU 6 type.



FIG. 10. Laboratory facility equipped with electron accelerator ILU 6 type: A) PP1 container, B) PP2 container, C, D) injection nozzle and stainless steel container (RV).

5. ECONOMIC OF WASTEWATER IRRADIATION PROCESS

The first and necessary step of any decision related to implementation of the radiation technology is to find the technical or economic reasons why radiation technology is better than more common alternative methods. The cost analysis can help to evaluate the economic parameters which are important implementation to technical description of any project. It is usually based on fixed and variable costs data evaluation. The fixed costs are not dependent on the facility output in primary terms. They are related to investment cost and administrative overhead. The equipment cost including accelerator, rent or plant floor space cost are the most common examples of fixed cost. In modern economy there are other components like employee health care, liability insurance, environmental costs, research and development, taxes. The variable costs incurred through the facility throughput and such expenses as material, utilities and labour costs should be included. Utility costs in electron beam operation are mostly electricity and the nitrogen for certain accelerator construction. Water consumption is relatively low due to commonly applied close loop in water cooling systems. It should be noticed that labour cost and cost of electricity vary widely depends on the country. Energy consumption is becoming one of the significant part of any cost analysis. Accelerator technology can be recognized as an equipment for conversion of electrical energy to ionizing radiation. The energy utilization efficiency depends directly on process characteristics, accelerator construction and electron beam utilization. It can be optimized by proper relation between electron energy, beam current and irradiated material properties. The variable costs calculated per unit of irradiated product are not constant for different volume output.

Based on initial data it was assumed that for the purpose of this study that ELV-12 accelerator will be used in radiation facility for industrial wastewater treatment. The process of wastewater treatment will include the following basic steps:

- Collecting wastewater effluent from the sedimentation tank;
- Pumping the wastewater to irradiation chamber;
- Irradiation of the wastewater in irradiation chamber;
- Pumping of the wastewater to the sedimentation tank.

Two story free standing building including an underground part for radiation chamber separated from accelerator room with a shield ceiling is foreseen (Table 1). Auxiliary equipment will be located at control room and installation rooms. The principal facility technological equipment consists of electron accelerator, reactor chamber, water pumps and air fans. Irradiation chambers with shield walls will be made from 2.4 g·cm⁻³ density reinforced concrete. The concrete ceiling separating the radiation part with beam scanner and electron beam exit window from the accelerator room located on the upper story is foreseen. Fresh air intake facility and ozone exhaust chimney should be installed as well.

TABLE 1. BASIC INDICATORS OF FACILITY BUILDING

No	Subject	Value	Remarks
1	Area under the building	186 m ²	12 m x 15.5 m
2	Building cubature	1944 m ³	
3	Shielding wall cubature	618 m ³	
4	Irradiation room	58.5 m ²	6.5 m x 9 m x 3 m (h)
5	Accelerator room	84 m ²	8 m x 10.5 m x 7.5 m (h)
6	Technical area	144.0 m ²	

Walls made from reinforced concrete $\rho=2.4 \text{ g}\cdot\text{m}^{-3}$

Tables 2 and 3 show the preliminary cost calculations based on the assumption that the Station will operate in a 3 shift system with 6 employees (five engineering and technical employees for operation of accelerator) and one auxiliary and office employee.

TABLE 2. RADIATION FACILITY BUILDING ECONOMICAL PARAMETERS

No	Specification	Quantity	Cost [k\$]
1	Radiation facility building - Two levels building construction, - Electrical cabinets of power line supply, - Electrical installations including lighting and fire protection, - Water and wastewater installations, - Air condition, ventilation, ozone removal and compress air installations, - Building cubature 1 944 m ³ , - Shielding walls volume V=618 m ³ ,	Set	500
2	Technological equipment: electron accelerators ELV-12 (spare parts, installation, training)	1	2 400
3	Power line transformer 630 kVA	1	20
4	Accelerator air and water cooling system	1	120
5	Pump station (8 000 m ³ /h) including stainless steel pipes	2	400
6	Irradiation chamber		60
7	Total		3 500
8	Technical design and reserve 20%		700
9	Total		4 200

TABLE 3. ESTIMATED COST FOR WASTEWATER ELECTRON BEAM TREATMENT

Initial capital		
Accelerator, spare parts, installation and training		2 400 000
Accelerator building		
Wastewater treatment chamber, piping and auxiliary equipment		500 000
Total		1 300 000
Fixed costs		
Depreciation (20 years)		210 000
Interest rate (8%)		336 000
Equipment maintenance		18 000
Administration		36 000
Total		600 000
Variable costs		
Labour		144 000
Electricity		294 000
Equipment maintenance		62 000
Total		500 000
Total annual costs		1 100 000
Annual throughput [t]		2 726 400
Total cost per ton [\$/t]		0.40

5.1. Remarks

- The operating schedule: 3 shifts per day; 24 h/day; 7 days/week; 365 day/year with availability 96% what corresponds to 8 410 h/year of facility operation.
- The capital cost is assumed to be financed at 8% interest for 20 years period.
- The electricity consumption 700 kW/h and electricity cost 0.05 \$/kWh.

– Average salary 2000 \$/month (6 persons). That includes: net salary, social security and welfare costs, pension funds, direct and indirect cost of training, payroll taxes and addition costs that occur in connection with employment.

6. SUMMARY

Wastewater radiation processing was found effective in improve sedimentation capability of irradiated liquid waste due to its physicochemical properties. It was found that irradiation considerably affects wastewater filterability, bound-water content, the enhancement of agglomeration of sludge particles. Dose 2.5 kGy was proposed for initiate radiation processes. The required dose level can be lowered depends on wastewater composition and its temperature. The basic irradiation facilities parameters have been worked out. The radiation installation should be located in close neighbourhood of tank of sediment.

REFERENCES

- [1] CHMIELEWSKI, A.G., ZIMEK, Z., BRYL-SANDELEWSKA, T., KUBERA, A., KALISZ, L., KAŻMIERCZUK, M., Disinfection of municipal sewage sludge in installation equipped with electron accelerator, *Radiat. Phys. Chem.*, **46 (4–6)**, (1995) 1071–1074.
- [2] KURUCZ, C.H.N., WAITE, T.D., COOPER, W.J., The Miami Electron Beam Research Facility: A Large Scale Wastewater Treatment Application, *Radiat. Phys. Chem.* **45(2)** (1995) 299–308.
- [3] PIKAJEW, A.K., PODZOROVA, E.A., BAKHTIN, O.M., Combined electron-beam and ozone treatment of waste water in the aerosol flow, *Radiat. Phys. Chem.* **49 (1)** (1997) 155–157.
- [4] RELA, P.R. SAMPA, M.H.O., DUARTE, C.L., COSTA, F.E., SCIANI, V., Development of an up flow irradiation device for electron beam wastewater treatment, *Radiat. Phys. Chem.* **57** (2000) 657–660.
- [5] MAKAROV, I.E., PONOMAREV, A.V., B., HAN, Demonstration plant for electron-beam treatment of Taegu Dye Industry complex wastewater, IAEA-TECDOC-1386, Emerging applications of radiation processing, Proceedings of a technical meeting held in Vienna, 28–30 April 2003; Vienna January 2004.
- [6] Laboratory EB Facility for Study Industrial Wastewater Effluents Treatment by Radiation” has been presented on 13th Tihany Symposium on Radiation Chemistry, held in Balatonalmadi, Hungary, 29 August–3 September (2015).

APPLICATION OF IONIZING RADIATION ON THE CORK WASTEWATER TREATMENT

J. MADUREIRA¹, A.I. PIMENTA¹, R. MELO¹, S. CABO VERDE¹, F.M.A. MARGAÇA¹, L. POPESCU², A. BESLEAGA²

¹Centro de Ciências e Tecnologias Nucleares, Instituto Superior Técnico, Universidade Técnica de Lisboa

Estrada Nacional 10, km 139.7, 2695–066 Bobadela, Loures
Portugal

²Alexandru Ioan Cuza University, Bulevardul Carol I 11, Iasi 700506
Romania

Abstract

The work done over the last years has shown that ionizing radiation can induced an increase in antioxidant activity in cork cooking water. To confirm this statement, antioxidant activity was evaluated using different methodologies as DPPH radical scavenging activity, reducing power and inhibition of β -carotene bleaching. The overall antioxidant activity was found to increase with ionizing radiation confirming the previous results. Toxicity tests were performed to access the added value of these wastewaters after irradiation and/or potential minimization of the environmental impact of treated water discharge in the environment. Two different methods for toxicity evaluation were performed in order to predict behaviour of different cells (bacterial and eukaryotic). The gamma radiation treatment seems to not affect the toxicity of cork compounds for *Pseudomonas fluorescens* growth inhibition test. On the other hand, the same radiation treatment of cork wastewater indicated to decrease the viability of Raw 264.7 and A549 cells, which could be related to a cytotoxicity effect of radiolytic products of cork compounds. These results could give two important outcomes: a) gamma radiation treatment does not affect the ecotoxicity of cork industry effluent which could reduce the environmental pollution problematics; b) cork wastewater cytotoxicity increases with gamma radiation treatment. Consequently, the applicability of the added-value cork wastewater by-products needs to be carefully studied to evaluate both the antioxidant potential as well as the cytotoxicity.

1. OBJECTIVE OF THE RESEARCH

Portugal and Spain congregate the main worldwide production and manufacture of cork. Portuguese cork exports represent around 70% of world market (APCOR - Portuguese Cork Association). Cork processing produces large quantities of wastewater mainly during the cooking stage of the process. The waste generated during this phase is an aqueous and complex dark liquor with high concentration of phenolic compounds such as phenolic acids and tannins, which are known for their high antioxidant activity. These waters have a high concentration in organic matter and a considerable toxicity.

The objective of this work was to perform a comprehensive assessment of the cork cooking water toxicity and antioxidant activity and the effects of gamma radiation treatment on these parameters.

2. INTRODUCTION

In the last decades, cork production and transformation processes became important sectors of the economic activity in Portugal. The wastewater produced during the cork cooking process represents the main source of wastes, approximately 1500 L per ton of cork. The major part is

discharged directly into the environment with little or no treatment contributing to the environmental pollution. The release of phenolic compounds from industries such as cork industry has become widespread in the world.

In the literature, it is reported the presence of phenolic compounds in cork wastewater [1] which are considered biorecalcitrant and with high toxicity. On the other hand, its potential as antioxidants is well-known [2] which could represent a potential way to valorize the wastewater from cork industry since it could replace synthetic antioxidants, used in cosmetic and/or food industry.

Additionally, studies have been published about the toxicity of some components of cork wastewater using microcalorimetric method [3] like phenolic compounds mixtures, and also about cork wastewater using *Vibrio fischeri*, *Daphnia magna*, and *Lemna minor* as test organisms to evaluate acute and chronic aquatic toxicity [4]. However, the biological effect of real cork wastewater is still unclear, since it is considered that the evaluation of toxicity should be done with organisms that have the ability to persist in a wide range of environments, including soils and surface of plants.

In this work, the focus is on the study of antioxidant activity and toxicity of cork cooking water and the influence of gamma radiation treatment on these parameters. Two different methods for toxicity evaluation were implemented in order to predict behaviour of different cells (procaryotic and eukaryotic). *Pseudomonas fluorescens* is used in the growth inhibition test as previously reported by Paz et al. [5]. On the other hand, two different eukaryotic mammalian cell lines, human and mouse, were used to compare the potential cytotoxicity effects of cork compounds in different life [6].

3. MATERIALS AND METHODS

3.1. Reagents, cells, microorganisms and materials

The cork wastewater was collected from *AMORIM Industrial Solutions*, a production and transformation cork industry located in Coruche, Portugal.

For antioxidant activity analysis: 2,2-diphenyl-1-picrylhydrazyl (DPPH) was obtained from Alfa Aesar (Ward Hill, MA, USA). Standards trolox (6-hydroxy-2,5,7,8-tetramethylchroman-2-carboxylic acid) and gallic acid were from Sigma (St. Louis, MO, USA). Methanol and all other chemicals were of analytical grade and obtained from common sources.

For ecotoxicity assay: *Pseudomonas fluorescens* were obtained from ATCC (ATCC® 13525™). Tryptone Soya Agar (TSA) and Tryptone Soya Broth (TSB) were obtained from Oxoid (UK).

For citotoxicity assay: A549 human lung alveolar epithelial cells were obtained from ATCC (ATCC® CCL-185™). Raw 264.7 mouse macrophages were obtained from ATCC (ATCC® TIB-71™). Dulbecco's Modified Eagle's Medium (DMEM), heat inactivated foetal bovine serum (FBS), penicillin-streptomycin, HEPES buffer, non-essential aminoacids, L-glutamine, sodium bicarbonate and sodium pyruvate were obtained from gibco, Thermo Scientific (MA, USA). WST-1 reagent were obtained from Roche (IN, USA).

Water was treated in a Milli-Q water purification system (Merck Millipore, USA).

3.2. Irradiation experiments

Irradiation experiments were carried out in a Co-60 experimental chamber (model Precisa 22, Gravier Lda, UK 1971 with an activity of 140 Tbq, 3.77 kCi, May 2015) located at Instalação de Radiações Ionizantes (IRIS) from Centro de Ciências e Tecnologias Nucleares (C2TN) of IST. All irradiations were conducted at a dose rate of 1.6 kGy h⁻¹. For antioxidant activity experiments, the cork wastewater samples were irradiated with a total dose of 10, 20 and 50 kGy. For toxicity evaluation, the samples were irradiated at 50 and 100 kGy. The absorbed doses were measured by routine dosimeters [7]. The local dose rate had been previously determined by Fricke method [8].

3.3. Antioxidant activity of cork wastewater samples

The antioxidant activity was evaluated by *in vitro* assays based on different mechanisms of action: DPPH radical scavenging activity, reducing power and inhibition of β -carotene bleaching. For this purpose, the non-irradiated and irradiated samples were lyophilized during 60 hours.

3.3.1. DPPH radical scavenging activity

This methodology was performed using an ELX800 Microplate Reader (Bio-Tek). The reaction mixture in each one of the 96-wells consisted of one of the different concentrations of the extracts (30 μ l) and methanolic solution (270 μ l) containing DPPH radicals (6×10^{-5} mol L⁻¹). The mixture was left to stand for 60 min in the dark. The reduction of the DPPH radical was determined by measuring the absorption at 515 nm. The radical scavenging activity (RSA) was calculated as a percentage of DPPH discoloration using the equation: % RSA = $[(A_{\text{DPPH}} - A_s) / A_{\text{DPPH}}] \times 100$, where A_s is the absorbance of the solution when the sample extract had been added at a particular level, and A_{DPPH} is the absorbance of the DPPH solution.

3.3.2. Reducing power

The methodology was performed using the Microplate Reader described above. The different concentrations of the extracts (0.5 mL) were mixed with sodium phosphate buffer (200 mmol L⁻¹, pH 6.6, 0.5 mL) and potassium ferricyanide (1% w/v, 0.5 mL). For each concentration, the mixture was incubated at 50°C for 20 min, and trichloroacetic acid (10% w/v, 0.5 mL) was added. The mixture (0.8 mL) was poured in the 48-wells, as also deionized water (0.8 mL) and ferric chloride (0.1% w/v, 0.16 mL), and the absorbance was measured at 690 nm.

3.3.3. β -Carotene bleaching

β -Carotene (2 mg) was dissolved in chloroform (10 mL) and 2 mL of this solution was pipetted into a round-bottom flask. After the chloroform was removed at 40 °C under vacuum, linoleic acid (40 mg), Tween 80 emulsifier (400 mg), and distilled water (100 mL) were added to the flask with vigorous shaking. Aliquots (4.8 mL) of this emulsion were transferred into different test tubes containing different concentrations of the extracts (0.2 mL). The tubes were shaken and incubated at 50 °C in a water bath. As soon as the emulsion was added to each tube, the zero time absorbance was measured at 470 nm. β -Carotene bleaching inhibition was calculated using the following equation: (Absorbance after 2 h of assay / Initial absorbance) \times 100.

3.4.Toxicity of cork wastewater samples

The samples of cork wastewater were filtrated with a 0.2 μm filter and different dilutions were prepared (100%, 50%, 10% and 1% of cork wastewater) in order to predict the effect of the concentration in the bacterial and eukaryotic cells growth.

3.4.1. *Pseudomonas fluorescens* growth inhibition assay

This test is based on the evaluation of the effects of the cork wastewater samples on the growth rate of a growing bacterial culture in a nutrient broth (TSB) under defined conditions of temperature and time [5]. The purpose of this test was to verify: a) if the compounds present in cork wastewater are toxic for the growth (inhibitory or bacteriostatic) of *Pseudomonas fluorescens* (a gram-negative bacteria); b) the effect of gamma radiation in the toxicity of these samples. For this experiment, 2 mL of a saturated culture of *P. fluorescens* were inoculated into 23 mL of sterile TSB until $\text{OD}_{620\text{nm}}=0.2$ (logarithmic growth phase). 100 μL of culture (104 CFU/mL) was immediately dispensed in 25 mL of TSB and 25 mL of cork wastewater samples described above. The wastewater samples were incubated at 28°C during 24h, with agitation. The inoculation in agar plates (TSA) was carried out at time 0 and 24 h, after decimal serial dilutions. The counts of the colonies in TSA were made after 24 h, 48 h, 72 h and 7 days.

3.4.2. Cytotoxicity assay

A549 and Raw264.7 cells were maintained at 37°C and 5% CO_2 , in DMEM supplemented with 1 mM L-glutamine, 10% FBS, 10 U/mL penicillin, 10 $\mu\text{g}/\text{mL}$ streptomycin, 1 mM sodium pyruvate, 0.075% sodium pyruvate, 0.1 mM non-essential amino acids and 10 mM HEPES buffer.

Cell viability was measured using the WST-1 assay based on quantification of mitochondrial activity as an indicator of cytotoxicity [6]. Twenty four hours before the challenging assay, 1×10^5 cells/mL of A549 and Raw264.7 cells were seeded into 96-well plates. In the following day, cellular monolayers were washed two times with PBS, 100 μL of fresh DMEM and 100 μL of cork wastewater samples were added to every well. The cells were treated with the cork wastewater (non-irradiated and irradiated) samples for 24 h, at 37°C and 5% CO_2 . In the next day, 100 μL of fresh DMEM was added. WST- 1 reagent was added to each well at 1/10 volume of the medium. The absorbance was quantified after incubating at 37°C for 6 h using an EZ Read 800 Microplate Reader from Biochrom (Cambridge, UK) at 450 nm with a reference wavelength of 620 nm. All treated A549 and Raw 264.7 cells were tested in duplicate in two independent experiments with three controls: (i) untreated cells in culture medium; (ii) samples in culture medium without cells; and (iii) culture medium only.

3.5.Data Analysis

All the assays were carried out in triplicate (antioxidant activity assays) or in duplicate (toxicity assays). The results are expressed as mean values with standard deviation (SD). Confidence intervals for means values were estimated considering a significance level of $p < 0.05$ and the number of replicates for each assay. Significant differences among mean values were checked by t-student test ($p < 0.05$).

4. RESULTS

4.1. Antioxidant activity of cork wastewater samples

The results concerning the antioxidant activity of cork wastewater samples are presented in Table 1.

TABLE 1. ANTIOXIDANT ACTIVITY OF CORK WASTEWATER SAMPLES, NON-IRRADIATED AND IRRADIATED AT DIFFERENT DOSES (IN EACH ROW DIFFERENT LETTERS MEAN SIGNIFICANT DIFFERENCES BETWEEN SPECIES (P<0.05))

Samples	0 kGy	10 kGy	20 kGy	50 kGy
Antioxidant activity (EC₅₀, µg/mL)				
DPPH scavenging activity	184 ± 2 ^a	181 ± 3 ^a	168 ± 4 ^b	133 ± 3 ^c
Reducing power	145 ± 1 ^a	142 ± 1 ^a	139 ± 1 ^b	119 ± 2 ^c
β - Carotene bleaching inhibition	130 ± 9 ^b	200 ± 10 ^a	129 ± 9 ^c	93 ± 5 ^d

As shown in Table 1, the irradiated samples tend to have a higher antioxidant activity (lower EC₅₀ values) than the non-irradiated one with the exception of one case (10 kGy irradiated sample in the assay of β - Carotene bleaching inhibition, which will be investigated). Gamma radiation treatment increases significantly both DPPH scavenging activity and β-carotene bleaching, by approximately 28% and reducing power approximately 18% for an absorbed dose of 50 kGy. The obtained results could be related to a greater amount of radical species generated during irradiation, namely hydroxyl radicals, leading to an increase of the number of antioxidant active compounds. This fact could be explained by hydroxyl radical attack to large molecules (e.g. tannins and other complex phenolic compounds) but without breaking the majority of the benzenic rings. The breaking of those compounds leads to an increase in the concentration of smaller phenolic structures with a globally higher antioxidant activity. On the other hand, the increase in lipid peroxidation inhibition could be associated with the amount of tocopherols which are powerful lipophilic antioxidants and could be radiolytic products of cork wastewater samples. The authors have already published work [9] suggesting that stable radiolytic products from gallic acid solutions irradiation are phenolic compounds with aliphatic chains. Nevertheless, this hypothesis should be confirmed by the identification of these compounds. These results are in agreement with those reported by Madureira et al. [10] with the same type of wastewater.

4.2. Toxicity

The presented graphics do not include the dilutions of cork wastewater since they do not introduce new relevant information. The authors considered only the “real” cork wastewater sample.

4.2.1. Growth inhibition test

Pseudomonas fluorescens was used as studied microorganism in the growth inhibition test, to access the ecotoxicity of cork cooking water samples. *P. fluorescens* has the ability to persist in a wide range of environments, including soils and surface of plants [11]. Due to this characteristic, *P. fluorescences* was select to evaluate de ecotoxicity of the cork wastewater samples.

Fig. 1 shows the results of the gamma radiation effects in the growth inhibition of *P. fluorescens* in the presence of cork wastewater.

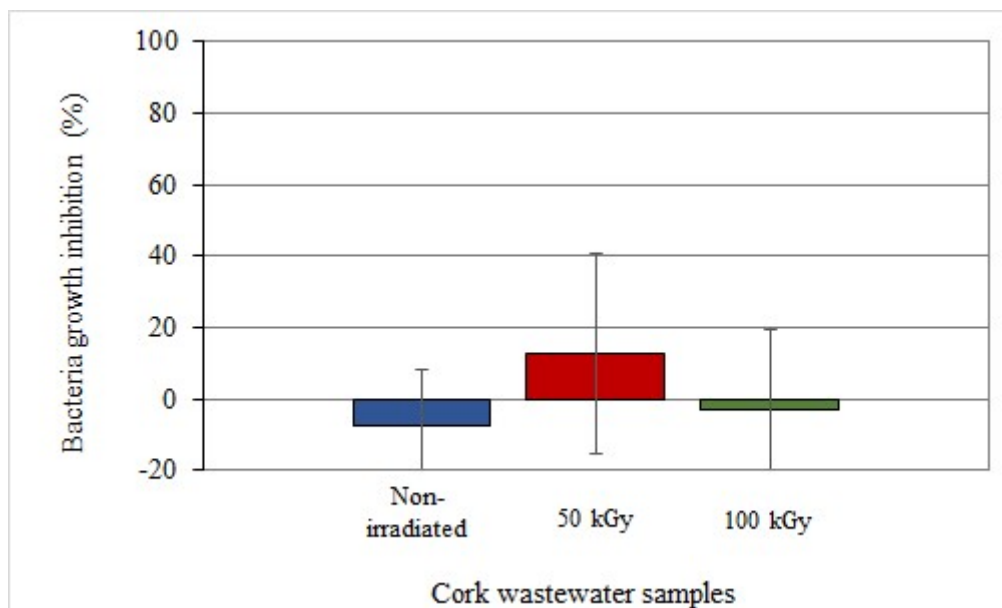

FIG. 1. *Pseudomonas fluorescens* growth inhibition in the presence of cork wastewater for irradiated and non-irradiated samples. All the differences between the mean values calculated were considered not significant (*t*-student test, $p < 0.05$).

The obtained results showed variations that are within the experimental error. Therefore, it is found that the presence of cork wastewater has no significant effect on the growth rate of *P. fluorescens*. The microorganism inoculation in the presence of cork wastewater samples seems to have no influence on the development and growing of *P. fluorescens*. Besides, the gamma radiation treatment of the samples at doses of 50 and 100 kGy does not cause any significant alteration on the bacteria growth rate. The results showed that all the studied cork wastewater samples have no toxic effect on *P. fluorescens* and that the presence of radiolytic products in the medium indicated no influence on the toxicity of this wastewater.

The evaluation of ecotoxicity of cork wastewater samples by the inhibition of *P. fluorescens* growth was accessed by two different methodologies: (i) optical density quantification at a wave-length of 620 nm (OD_{620nm}); and (ii) determination of the number of colony forming units per mL (CFU/mL). Despite some minor differences in the obtained values, both methods demonstrated the same trend – the studied samples (irradiated and non-irradiated) have no toxic influence on the growth of *Pseudomonas fluorescens*. These results indicate that these methodologies could be used independently in the study of the toxic behaviour of the samples.

4.2.2. Cytotoxicity

The study of cytotoxicity could be a preliminary approach to evaluate the applicability of cork wastewater extractable compounds in industries like food or cosmetic industry.

Figs. 2 and 3 present the results of cork wastewater cytotoxicity with the gamma radiation treatment.

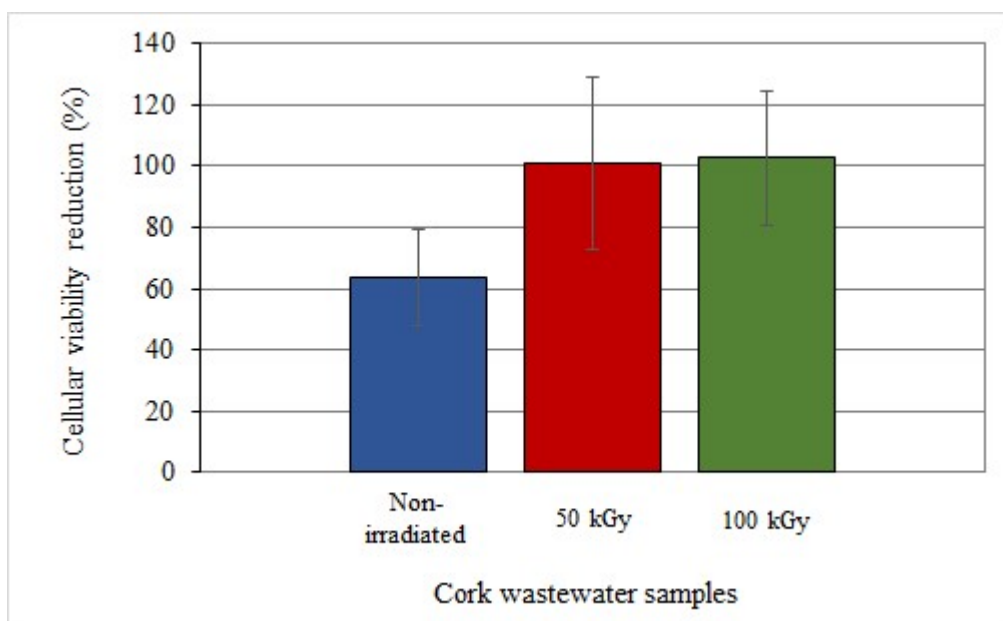

FIG. 2. Cellular viability reduction of A549 in the presence of cork wastewater for irradiated and non-irradiated samples. All the differences between the mean values calculated were considered significant (*t*-student test, $p < 0.05$).

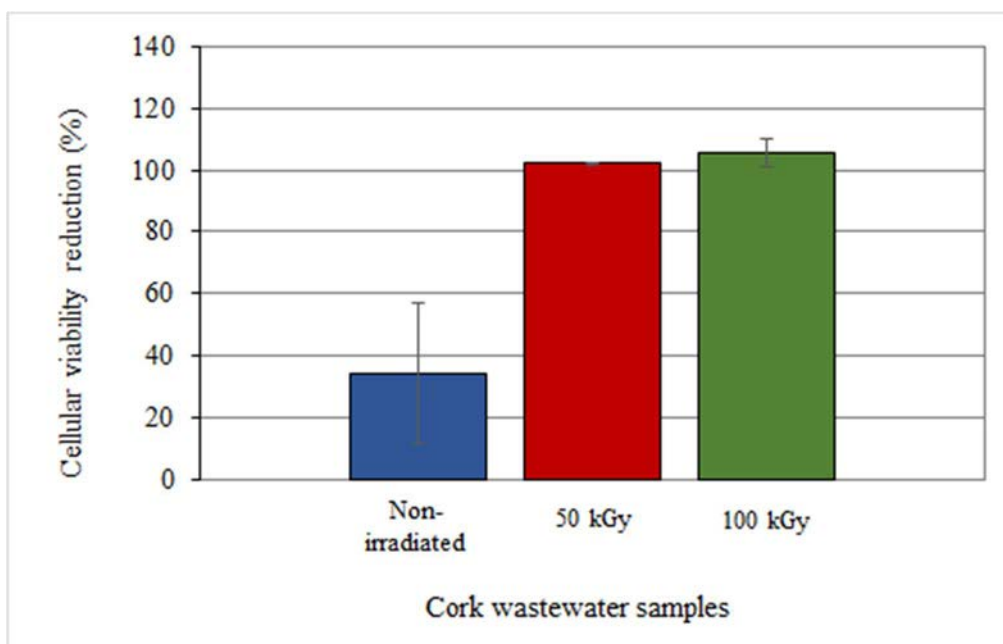

FIG. 3. Cellular viability reduction of Raw264.7 in the presence of cork wastewater for irradiated and non-irradiated samples. All the differences between the mean values calculated were considered significant (*t*-student test, $p < 0.05$).

The evaluation of the cork wastewater cytotoxicity by cell viability measurement suggested a toxic behaviour of the samples. Both, A549 and Raw264.7 cells demonstrated a significant reduction on their viability – 63.8% and 35.3%, respectively, when non-irradiated cork wastewater was added to the growth medium. The presence of the cork water samples caused

a reduction of the WST-1 mitochondrial metabolism that reflects a lower number of viable cells/lower cellular activity relatively to the cells that were growing only in the presence of DMEM growth medium. Considering both cell types it seemed evident a higher sensibility of human cells (A549 cells) to the cork wastewater components when compared with mouse Raw264.7 cells.

Considering the irradiated samples (at 50 kGy and 100 kGy) it was notorious an increase of the toxic effect on the studied eukaryotic cells. At both absorbed doses the effect of radiolytic products of cork wastewater caused a reduction of at least 100% on the cellular viability. This effect seemed to be less drastic when several dilutions of the samples were tested (data not shown), which could reveal that the concentration of cork wastewater compounds (irradiated and non-irradiated) is a critical factor for the toxicity effect on eukaryotic cells. A dilution 1:10 of cork wastewater in pure water is sufficient to diminish the toxicity of the original samples at a level similar to that obtained for the cellular growth control. Taken together, the obtained results indicate that cork wastewater caused a significant reduction on the survival rate of the studied cells. When the samples are treated with gamma radiation at doses of 50 and 100 kGy, the cytotoxicity effect increased in an extremely significant way, causing the death of the totality of the cells. This behaviour could be a consequence of the presence of cork radiolytic products and it is likely that this degradation product could be much more toxic than the initial cork wastewater components.

As mentioned before, the identification of the cork wastewater radiolytic products could bring a wide range of information to the toxicity study of this type of complex samples.

5. SUMMARY

In the framework of the CRP on “Radiation treatment of wastewater for reuse with particular focus on wastewaters containing organic pollutants” Portuguese team developed studies on the implementation of ionizing radiation technology as a complementary treatment for industrial effluents and increase the added value of these wastewaters. Based on these assumptions, preliminary studies of the gamma radiation effects on the antioxidant compounds present in cork cooking water were carried out. Different antioxidant activity assays were used as Ferric Reducing Power (FRAP) assay, DPPH radical scavenging activity, reducing power and inhibition of β -carotene bleaching. The phenolics content was also evaluated by Folin-Ciocalteu method. Results pointed out that gamma radiation increases both the amount of phenolic compounds and antioxidant activity of cork cooking water. This conclusion becomes relevant thinking in the application perspective of the extractable compounds from cork wastewater should be used in other industries like food or cosmetic ones. Thus, toxicity of these new compounds has to be evaluated. Ecotoxicity and cytotoxicity assays were done and the obtained results suggested two important outcomes: a) gamma radiation treatment do not affect the ecotoxicity of effluent which could reduce the environmental pollution problematics; b) cork wastewater cytotoxicity increases with gamma radiation treatment. Consequently, the applicability of the added-value cork wastewater by-products needs to be carefully studied to evaluate both the antioxidant potential and the cytotoxicity. Beside these studies, the removal of phenolic compounds was investigated using low-cost adsorbents: one synthesized and one commercial. Regarding the adsorption mechanism, the results suggested that both activated carbons are suitable for phenolic compounds extraction. However, the adsorption appears to be more favourable in the synthesized carbon. This was found to be mesoporous, which provides increasing accessibility to micropores and promotes the initial adsorption rate as well as selectivity for the four phenolic compounds adsorption. The overall results obtained during the last year's

highlights the potential use of ionizing radiation as complementary technology in industrial wastewater treatment. Otherwise, several aspects have to be taken into account in order to reuse and optimize treated wastewater. In 2015, the Group had made 3 posters presentation in international conferences and 1 oral presentation.

ACKNOWLEDGEMENT

The authors thank International Atomic Energy Agency (Contract No. 16513). We are grateful to FCT (Portugal) for the funding of RECI/AAG-TEC/0400/2012 “Application of Ionizing Radiation for a Sustainable Environment” project. We are also grateful to the cork industry (Amorim S.A) for allowing us to collect all the samples necessary for the accomplishment of this work.

REFERENCES

- [1] MINHALMA, M., PINHO, M.N., Tannic-membrane interactions on ultrafiltration of cork processing wastewaters, *Separation and Purification Technology* **22–23**, (2001) 479–488.
- [2] BENITEZ, F.J., ACERO, J.L., GARCIA, J., LEAL, A.I., Purification of cork processing wastewaters by ozone, by activated sludge, and by their two sequential applications, *Water Research* **37**, (2003) 4081–4090.
- [3] CHEN, H., YAO, J., WANG, F., ZHOU, Y., CHEN, K., ZHUANG, R., CHOI, M.M.F., ZARAY, G., Toxicity of three phenolic compounds and their mixtures on the gram-positive bacteria *Bacillus subtilis* in the aquatic environment, *Science of the Total Environment* **408**, (2010) 1043–1049.
- [4] MENDONÇA, E., PICADO, A., SILVA, L., ANSELMO, A.M., Ecotoxicological evaluation of cork-boiling wastewaters, *Ecotoxicology and Environmental Safety* **66**, (2007) 384–390.
- [5] PAZ, M., MUZIO, H., MENDELSON, A., MAGDALENO, A., TORNELLO, C., BALBIS, N., MORETTON, J., Evaluation of Genotoxicity and Toxicity of Buenos Aires City Hospital Wastewater Samples. *Journal of the Brazilian Society of Ecotoxicology*, **1**, (2006) 1–6.
- [6] MA, Y., ELANKUMARAN, S., MARR, L.C., VEJERANO, E.P., PRUDEN, A., Toxicity of engineered nanomaterials and their transformation products following wastewater treatment on A549 human lung epithelial cells, *Toxicology Reports*, **1**, (2014) 871–876.
- [7] WHITTAKER, B., WATTS, M., The influence of dose rate, ambient temperature and time on the radiation response of Harwell PMMA dosimeters. *Radiation Physics and Chemistry*, **60 (1–2)**, (2001) 101–110.
- [8] AMERICAN SOCIETY FOR TESTING AND MATERIALS, Practice for using the Fricke reference standard dosimetry system, **12.02**. Pennsylvania, USA. (1992).
- [9] MELO, R., LEAL, J.P., BOTELHO, M.L., Radiolytic degradation mechanism of gallic acid and its end-products, *Rapid Communication in Mass Spectrometry*, (2011) 218–222.
- [10] MADUREIRA, J., MELO, R., BOTELHO, M.L., LEAL, J.P., FONSECA, I.M., Effect of ionizing radiation on antioxidant compounds present in cork wastewater. *Water Science and Technology*, **67 (2)**, (2013) 374–379.
- [11] SCALES, B.S., DICKSON, R.P., LIPUMA, J.J., HUFFNAGLE, G.B., Microbiology, Genomics, and Clinical Significance of the *Pseudomonas fluorescens* Species Complex, an Unappreciated Colonizer of Humans, *Clinical Microbiology Reviews*, **27, 4**, (2014) 927–948.

EXTENSIVE USE OF GAS CHROMATOGRAPHY – MASS SPECTROMETRY FOR THE CHARACTERIZATION OF THE EFFECTS OF RADIATION TREATMENT OF WASTEWATER

M. VIRGOLICI, V. MOISE, M. CUTRUBINIS, D. NEGUT, I. STANCULESCU
Horia Hulubei National Institute of Physics and Nuclear Engineering (IFIN-HH) Center for Technological Irradiations - IRASM Department
Magurele, Ilfov
Romania

Abstract

Sewage water is the main problem to be tackled, as Romania had reported in 2010 a degree of connection to sewer of only 54.28% and a degree of connection to the sewage treatment plants of only 43.24%, which makes enough room for both conventional and non-conventional advanced water treatment technologies.

A radiolytic study was carried out on model wastewater samples spiked with organochlorine pesticides, using hexachlorobenzene (HCB) and Polychloro Byphenils (e. g. PCB 52) as model target analytes. Experimental model sewer wastewater samples were irradiated at IRASM Multipurpose Irradiation Facility (IFIN-HH, Bucharest-Magurele), an industrial gamma irradiator with an activity of 288 kCi in January 2013. The absorbed dose received by the samples was between 1 and 13 kGy at a dose rate of 1 kGy/h. Dosimetric analysis was performed with ethanol-chloro-benzene dosimetry system. The organochlorine compounds and PCBs concentration was monitored by gas chromatography with simultaneous micro electron capture detection and mass spectrometric detection. ISO 6468:1996 sample preparation protocols were used for the recovery of target analytes from the wastewater matrix. The concentration of the target analytes decreased ten times after the irradiation treatment at absorbed doses around 1 kGy. A molecular modelling study was done to predict the most probable radiolysis products and in correlation with the GC/MS results to speculate some preferential radiolysis pathways. A feasibility study was made for installing at IFIN-HH a self-shielded electron accelerator (6 MeV, 12 kW, which can be re-located), which could cover all present and under development applications, including environmental applications of radiation technologies, like wastewater and sludge treatment for decomposition of POPs.

1. OBJECTIVES OF THE RESEARCH

To improve the knowledge on irradiation treatment of wastewater and its side-effects and to prepare the conditions for a large experiment, by:

- assessing GC/MS and GC-ECD as analytical methods for pollutants and radiation by-products characterization and quantification in wastewater;
- dose optimization of radiation treatment at laboratory scale using a Co60 gamma research irradiator and a Co60 gamma industrial irradiator;
- to make a feasibility study for commissioning a mobile (or which can be re-located) e-beam demonstration laboratory and to identify most convenient situations for wastewater radiation treatment in Romania.

2. INTRODUCTION

Several potential water polluting industries with POPs drastically decreased their production in the last 25 years in Romania, such as: Paper, Textile and Dye manufacturing industries. The water demand in Romania decreased in the last 25 years at half the value from 1990. Although rated as one of the countries with the lowest water resources in EU, Romania is not part of the countries with possible water shortages in 2025. Other part of the world water crisis is the issue of water availability in the required quantity and quality of life. In Romania, only 79.55% of all surface water bodies assessed in 2011 met the environmental objectives (have good ecological status / good ecological potential). Regarding the assessment of groundwater bodies, in 2011, only 81.6% of groundwater bodies achieve quality objectives. Although Romania is not on a map of the water crisis, water resources of our country are relatively poor and unevenly distributed in time and space. In theory, these amount 134.6 billion m³ (consisting of surface water-rivers, lakes, the Danube - and groundwater), from which the usable resource, according to the degree of watershed planning is about 40 billion m³. Specific endogenous resources of Romania reported to the population number are 1894 m³ / year / inhabitant, Romania being one of the countries with the lowest water resources in Europe. If exogenous water resources (representing the contribution of rivers that form in other countries and then enters the country) are also taking into account - in Romania's case will consist of Danube and the higher streams of Siret basin – about 170 km³ / year, Romania's total water resources raise to 212 km³ / year. Therefore, Romania depends very largely on water resources coming from different countries upstream. These water resources are not fully usable. Unlike the countries of Western and Northern Europe, the lack of sufficient water resources are likely to become a limiting factor for economic development, if not promoted a strict policy of rational use of water by stakeholders.

The water demand in 2011 reported in Romania consists of 15.8% for population, 17.1% for agriculture and 67.0% for the industry. Sewage water is the main problem to be tackled, as Romania had reported in 2010 a degree of connection to sewer of only 54.28% and a degree of connection to the sewage treatment plants of only 43.24% (www.rowater.ro), which makes enough room for both conventional and non-conventional advanced water treatment technologies.

Between 2007 and 2011, ca. 2 997 173 000 euro were invested nationwide for the expansion and rehabilitation works of water infrastructure (<http://www.rowater.ro>).

Following the accession of Romania to the European Union, have resulted in a number of commitments involving significant investment in water and wastewater sector, over relatively short periods of time. Thus, in accordance with the Accession Treaty, Romania obtained following transition periods for compliance with EC Directive no. 91/271/EEC concerning urban waste water:

- until 2015, for 263 agglomerations of more than 10 000 inhabitants;
- until 2018, for 2 346 agglomerations between 2 000 and 10 000 inhabitants.

The planned work in these projects aim to achieve a number of about 170 new or rehabilitated wastewater treatment plants and an increase in the volume of treated wastewater, respectively, from 35% to 60%. It is also anticipated an increase in people connecting to water the regional system from 52% to 70% (<http://www.rowater.ro>).

Wastewater treatment is becoming ever more critical in large industrial centres due to diminishing water resources, increasing water disposal costs, and new discharge regulations that have lowered permissible contaminant levels in waste streams.

Industrial water is processed with the aim of reusing it. The normal methods have the task of microbiological cleaning (using chlorine et al) and the removing of suspended particles.

While several countries worldwide have started feasibility studies for establishment of demonstration plants to treat wastewater for reuse in urban irrigation and some industrial uses. These studies show that the treated municipal and industrial wastewater effluents are still contaminated with persistent organic pollutants (POPs), such as pesticides and endocrine disruptors in low concentration and there is a need for optimized and validated analytical methods to fully characterize and evaluate effects of by-products in treated wastewaters.

We aim to investigate the utilization of ionizing radiation (gamma or accelerated electrons) as an alternative advanced water treatment technology for reuse, with particular focus on wastewaters containing "persistent organic pollutants" (POPs).

Gas chromatograph coupled with mass spectrometry (GC/MS) was chosen, because is able to identify and measure small molecules resulted from POPs irradiation treatment, by comparison with a standardized library (200 thousand compounds), in the case were no analytical standards (reference substances) are available for the radiolysis products, giving us at least an idea of the class of compounds (and possible an insight about their toxicity).

Organochlorine pesticides and Polychlorinated Byphenils are groups of toxic compounds, most of them being included in the Stockholm convention list of persistent organic pollutants. They are characterized by high chemical stability and may lead to marked changes in the aquatic ecosystem via bioaccumulation and biomagnifications. Radiolytic degradation with ionizing radiation (gamma or electron beam) is thought to be a promising treatment for their decomposition to more environmental friendlier compounds.

„Knowledge is the engine for success and it is of the greatest importance in the social and economic development of Romania.” Knowing this, the purpose of IFIN-HH is to generate, gather and spread the knowledge in all its areas of work and to actively participate in the knowledge transfer towards society. Starting from these premises in 2015 IFIN-HH ordered a feasibility study for a self-shielded electron beam accelerator (which can be re-located) as a R&D demonstration platform for various applications (including environmental applications like wastewater treatment) not economically feasible by gamma irradiation. A project proposal for a Large R&D Infrastructure entitled "Electron Accelerator for Technological Irradiation Applications" was submitted for evaluation at a national grant competition at the section "Investment projects for public institutions (Universities and R&D Institutes)".

3. MATERIALS AND METHODS

The experimental part was focused on optimization and extension of applicability of ISO 6468:1996 [1] standardized analytical method for the validation of radiation treatment of waste waters containing certain organochlorine insecticides or poly-chlorinated biphenyls (PCBs). The analytical methods used were gas chromatography coupled with mass spectrometry and micro electron capture detector. The decomposition of organochlorine insecticides or poly-chlorinated biphenyls (PCBs) from spiked sewer waste water samples was achieved with gamma irradiation. A GC/MS screening in correlation with a molecular

modelling study were also performed for the identification of possible persistent organic pollutants (POPs) radiolysis products.

Two sets of irradiation experiments were performed: one with acetone or methanol as POPs solvents miscible with water; and other with the model waste water samples used in the irradiation experiments, which had a spiked concentration of 1 ppb POPs and 1 % solvent (methanol).

3.1. Samples and sample preparation

Spiked samples, positive and negative quality controls were prepared as follows:

Sampling: real treated sewer waste water samples were taken from the IFIN-HH waste water treatment station, compact type (in prefabricated container, installed by EDAS EXIM, www.edas.ro), with membrane biological reactor (MBR), and a maximum treatment capacity of 100 m³/day. Samples were taken in 2.5 l brown glass containers with polytetrafluoroethylene (PTFE) caps (thus avoiding contact with other plastic materials which may serve as adsorbent materials for POPs), and stored overnight in a freezer set at 4 °C. Next day, samples were decanted and diluted 1 part waste water at 9 parts deionized water and further used at spiked test specimens preparation.

Negative quality controls preparation: 1 ml of acetone or methanol (HPLC purity, Sigma-Aldrich) was transferred in 1 l Berzelius graduated beakers and filled with deionized water. High dose Co⁶⁰ gamma irradiation experiments (with absorbed doses of 65 and 130 kGy, at a dose rate of 1.3 kGy/h) were conducted and methanol was selected over acetone, because acetone produced flocculation after irradiation.

Positive quality controls preparation: 1 ml of methanol with 1 ppm hexachlorobenzene (HCB) or 2,2',5,5'-Tetrachlorobiphenyl (PCB 52) were transferred in 1 l Berzelius graduated beakers and filled with deionized water. The final POPs concentration was 1 ppb HCB or PCB 52 in water.

Spiked test specimens preparation: 1 ml of methanol with 1 ppm HCB or PCB 52 were transferred in 1 l Berzelius graduated beakers and filled with diluted real treated sewer waste water (waste water : deionized water = 1:9). The final POPs concentration was 1 ppb HCB or PCB 52 in water. The spiked test specimens were stored at 4 °C until analysis.

Standard solutions preparation for gas chromatographic quantitative analysis: 10 mg of HCB or PCB 52 (purity: reference standards for gas chromatography) were transferred into volumetric flasks of 100 ml, further filled with n-hexane (for GC-MS & GC-ECD calibration curves) or methanol (for preparation of positive quality controls and spiked samples), thus obtaining stock standard solutions of 100 ppm (POPs concentration, stable for maximum one year at 4°C). Standard solutions of 1000 ppb, 100 ppb, 10 ppb, 1 ppb and 0.1 ppb of HCB or PCB 52 were prepared, according to the GC-ECD method linearity range (between 0.1 ppb & 1000 ppb, the detector commonly exhibiting a 10 000-fold linear range).

3.2. Irradiation treatment

To identify the most convenient irradiation conditions for experimental model sewer waste water treatment, samples were irradiated at IRASM Multipurpose Irradiation Facility (IFIN-HH, Bucharest-Magurele), a SVST Co-60/B tote-box, wet storage (max. 2 MCi) industrial gamma irradiator (with 360 kCi in Jan 2012). The absorbed doses were 1.3, 4.5, 13, 65 and

130 kGy, at a dose rate of 1.3 kGy/h. The dosimetry was performed with ethanol-chlorobenzene (ECB) dosimeters ($\pm 2\%$ standard deviation) [2].

Two consecutive irradiation experiments were carried out.

First, for establishing the stability of spiking solvents (acetone versus methanol, with a concentration of 1% in deionized water) to irradiation treatment, after an intriguing initial irradiation experiment, which led to solution colouring into white-yellow and decantation of yellowish deposits; The absorbed irradiation doses (65 and 130 kGy) were 100 folds higher than irradiation doses used in industrial applications for waste water treatment. At high dose acetone undergoes radiolytic reactions in water, forming a colloidal interfering matrix. Methanol was more stable, no significant interfering matrix could have been evidenced, and for this reason it was selected as spiking solvent for the persistent organic pollutants irradiation decomposition experiments (Fig. 1).

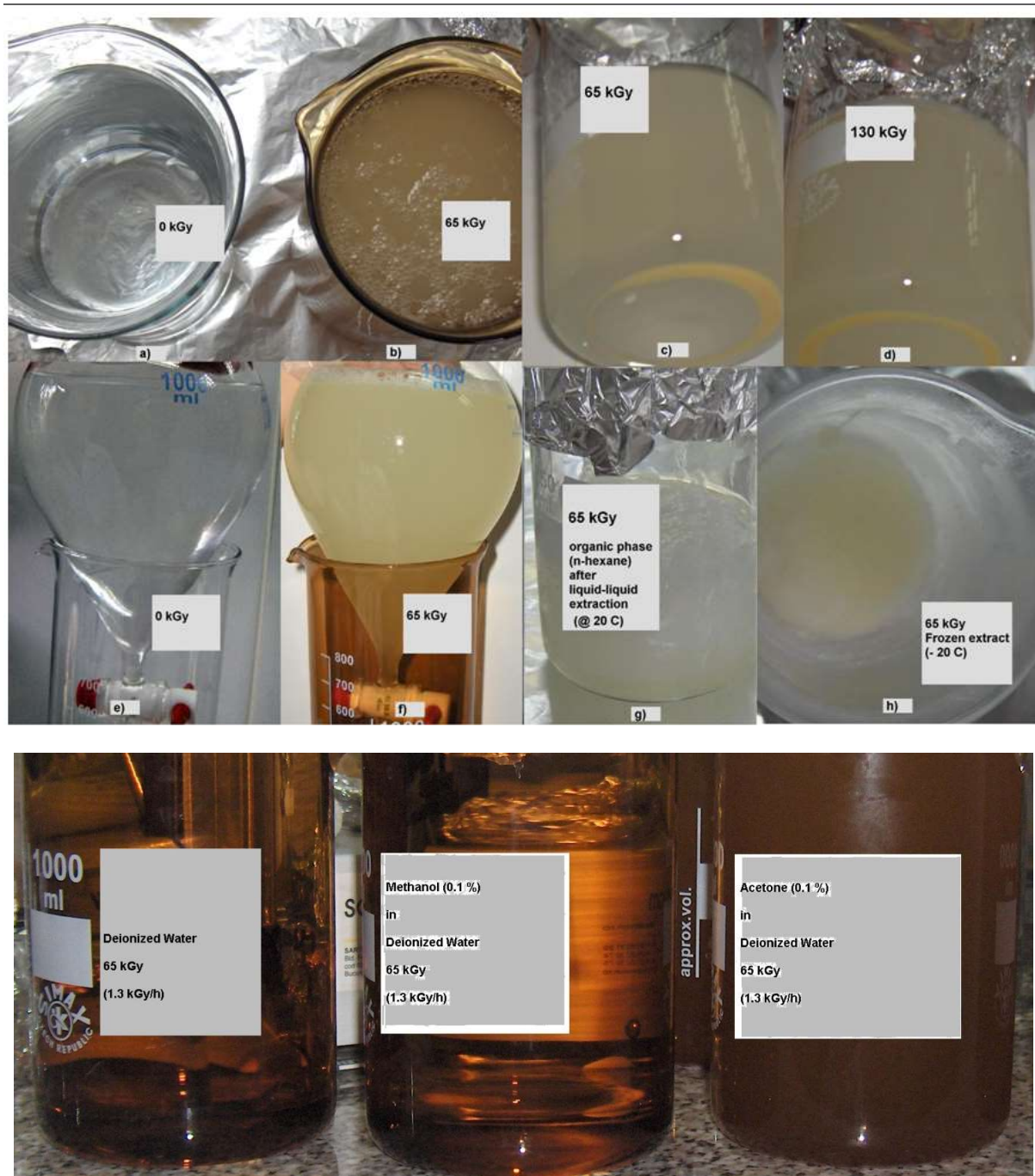

FIG. 1. Irradiation experiment of acetone and methanol as spiking solvents (1 % in deionized water) for PCB 52 and HCB (having a concentration of 1 ppb in deionized water, obtained by adding 1 ml of acetone with 1 ppm of POPs to 1 l of deionized water): a) - f) unirradiated & irradiated positive quality controls before and after liquid-liquid extraction; g) & h) organic phase collected after liquid-liquid extraction before and after separation from interfering matrix by freezing at -20°C .

Second, for establishing the irradiation dose which will reduce at least 10 times the target POPs concentration in sewer waste water for our experimental irradiation geometry. The purpose of the experiments was to develop a validation protocol for radiation decomposition of target POPs in sewer waste water. The experimental absorbed doses were 1.3, 4.5 and 13 kGy, at a dose rate of 1.3 kGy/h. The irradiated samples consisted in deionized water and sewer waste water spiked with HCB or PCB 52 (1 ppb) and methanol (0.1%).

3.3. Sample processing

3.3.1. Liquid–liquid extraction

1 litre of test specimen (water sample) was completely transferred into a separation funnel. 100 ml of n-hexane (GC purity, e.g. “Pestiscan”) was added and mixed for 20 min, followed by phase separation for 10 min (depending on residual wastewater interfering matrix). The aqueous and organic phases were recovered separately. The liquid-liquid extraction was repeated 2 times with fresh volumes of n-hexane into the same separation funnel and the organic phases were collected and reunited.

3.3.2. Separation from interfering matrix

The organic phase collected after liquid-liquid extraction was cooled down to -20°C, and kept for 2 hours. Depending on the interfering matrix (which can appear sometimes as foam into the organic phase) a number of freezing cycles between room temperature and -20°C were applied, until transparent liquid organic phase was completely separated from the frozen solid decanted phase. The transparent liquid organic phase was transferred into a glass round-bottom flask for rotary evaporators.

3.3.3. Sample extract concentration

Sample extract was concentrated to a small volume of 0.5–1 ml in a constant vacuum of 340 mbar, obtained with Heidolph Laborota 4002 rotary evaporator with vacuum pump. The glass round-bottom flask was thermostated during evaporation on a water bath at 40°C. The concentrated sample extract was further quantitatively transferred (using an automated micro pipette with disposable PTFE 1000 µl tip) into a 2 ml GC vial. Small volumes of clean solvent were used to wash the evaporation vessel twice for completing the extract volume to 1 ml, and immediately seal the GC vial.

The recovery efficiency was calculated based on the unirradiated spiked quality control samples which were processed in the same batch with the irradiated ones.

3.4. The chromatographic analysis

The organochlorine pesticides concentration was monitored with gas chromatography (GC) with simultaneous micro electron capture detection (ECD) and mass spectrometric detection (MS, in single ion monitoring - SIM - mode).

Agilent GC 6890N was used with the following configuration: auto sampler (with 10 µl Hamilton syringe), classical hot split splitless (SSL) injector with a straight liner (1000 µl, packed with deactivated glass wool), a 1 m x 0.25 mm retention gap connected at one end with the SSL injector and to the other end with a quartz “Y” capillary connection, from which emerged two identical HP-5ms columns, 30 m x 0.25 mm (with 0.25 µm film of (5%-phenyl)-methyl-polysiloxane non-polar, bonded and cross linked stationary phase). Each HP-5ms column was further connected with a detector: one with the Agilent micro electron capture detector (ECD); and the other one with Agilent 5975 inert MSD. The MSD had the following configuration: electron ionization source; quadrupolar mass analyser (m/z 2 Da to m/z 1050 Da); and high energy dynode (HED) detector.

The software applications used for GC-ECD & GC/MS data acquisition and data analysis were: Agilent Enhanced Chemstation software (version D.02.00.275); NIST 2005 GC/MS

mass spectral library; NIST MS 2.0 library search software and AMDIS (version 2.62) automated mass deconvolution and identification system.

Injection of 1 μl of n-hexane (target POP's concentration of $1 \div 10^{-3}$ ng/ μl) was performed in hot (280°C) splitless mode (1:1) for 1 min, followed by inlet purge at 100 ml/min for 7 min, and inlet purge at 50 ml/min for the rest of chromatographic method and inlet standby mode. Helium (99.9999% purity) has been used as carrier gas, with a capillary constant flow of 3 ml/min through the retention gap, further divided approximatively into 2 ml/min through the MSD column and 1 ml/min through de ECD column.

Column temperature programming consisted in the following profile: isothermal for 8 min at 80°C, ramp with 12°C/min to 310°C and isothermal (column conditioning) for 3 min.

3.5. Quantitative GC

The ECD detector had the following parameters: constant makeup flow mode (nitrogen, 60 ml/min, 99.9995% purity), thermostated at 350°C, data acquisition rate of 50 Hz.

The MSD detector had the following parameters: transfer line set at 280°C; electron ionization source set at 230°C; mass analyser set at 180°C and used in single ion monitoring mode (SIM mode, monitoring 5 fragment ions, e. g. for HCB m/z 142, 249, 283, 284 and 285 Da; or for PCB 52 m/z 220, 222, 290, 292 and 294 Da), in low mass resolution mode (0.7-0.9 Da) with a dwell time of 50 ms (3.65 cycles/sec).

Calibration curves were made for PCB 52 and HCB for the concentrations between 0.0001 \div 1 mg/l of n-hexane, equivalent to 0.0001 \div 1 $\mu\text{g/l}$ of water.

The data analysis of the samples from the second irradiation experiment showed that an absorbed dose of 1.3 kGy reduces approximatively 10 times the concentration in water of PCB 52 and HCB by radiolytic decomposition (chromatograms given in Fig. 2).

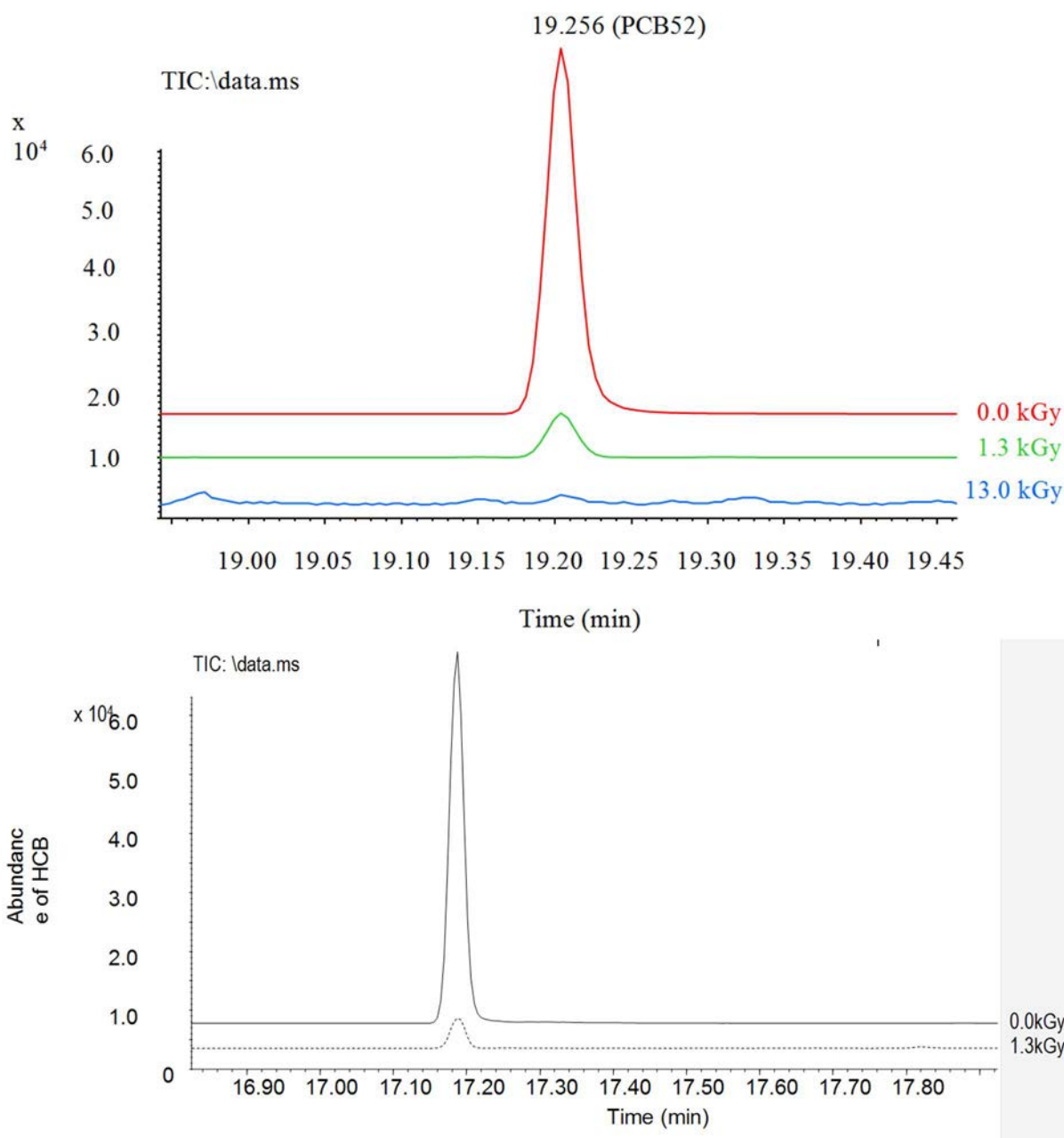

FIG. 2. Total Ion Chromatogram (TIC, SIM mode) for the positive quality control spiked with PCB52 (700 ng/l) and HCB (1000 ng/l) before and after irradiation treatment.

3.6.GC-MS screening

Agilent 5975 MSD equipped with electron ionization (EI mode at 70 eV) source was used with following parameters: MSD transfer line temperature set at 280°C, source temperature set at 230°C, mass analyser temperature set at 180°C, data acquisition in SCAN mode from 35 to 700 a.m.u. with a threshold of 100 counts and a sampling rate of 2³ samples/a.m.u. corresponding to 1.13 scans/sec. Compound identification was performed via mass spectra deconvolution and retention index with AMDIS software and spectral matching with NIST 2005 GC/MS library. Data analysis workflow is shown in Fig. 3.

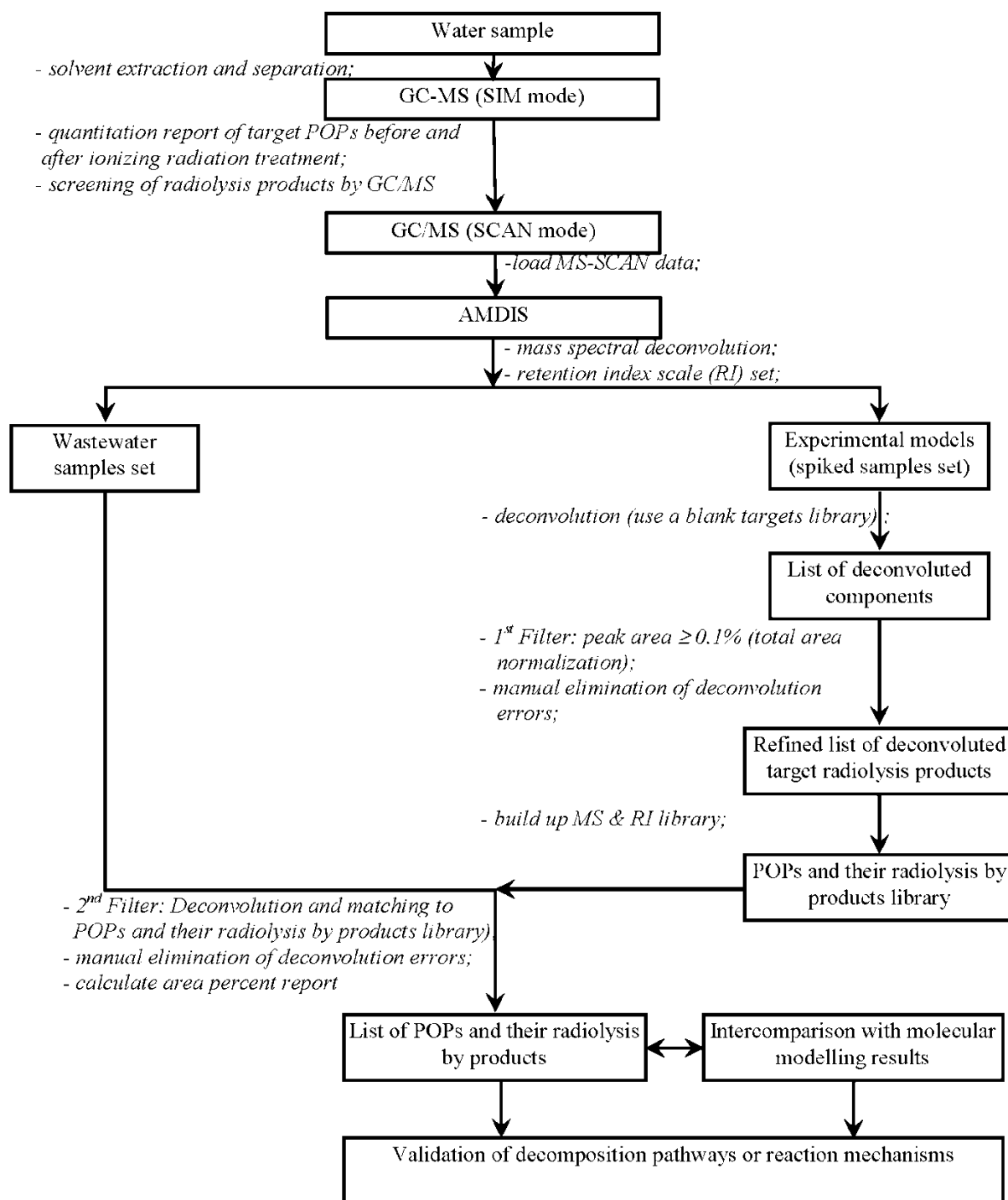

FIG. 3. AMDIS data analysis protocol for POPs radiolysis products screening [Virgolici et. al 2010]

3.7. Molecular modelling

A molecular modelling study was done to predict the most probable radiolysis products and it is correlated with the GC/MS results to speculate some preferential radiolysis pathways. Modelling of the reactants, transition states and products was done with quantum semi-empirical AM1 and PM3 methods, included in Hyperchem and Ampac programs. Starting geometry of POP's and their derivatives was obtained from the 2D manual drawing of the molecule and from the 3D automatically build molecular model. To obtain an accurate

structure, geometry optimization with Polack-Ribiere algorithm, Restricted and Unrestricted Hartree Fock approximations and gradient of 0.01 kcal/mol·Å was done. Heat of formation, HOMO-Highest Occupied Molecular Orbital- and LUMO-Lowest Unoccupied Molecular Orbital- frontier orbitals energy and shape, activation energy were obtained and correlated with the compounds reactivity.

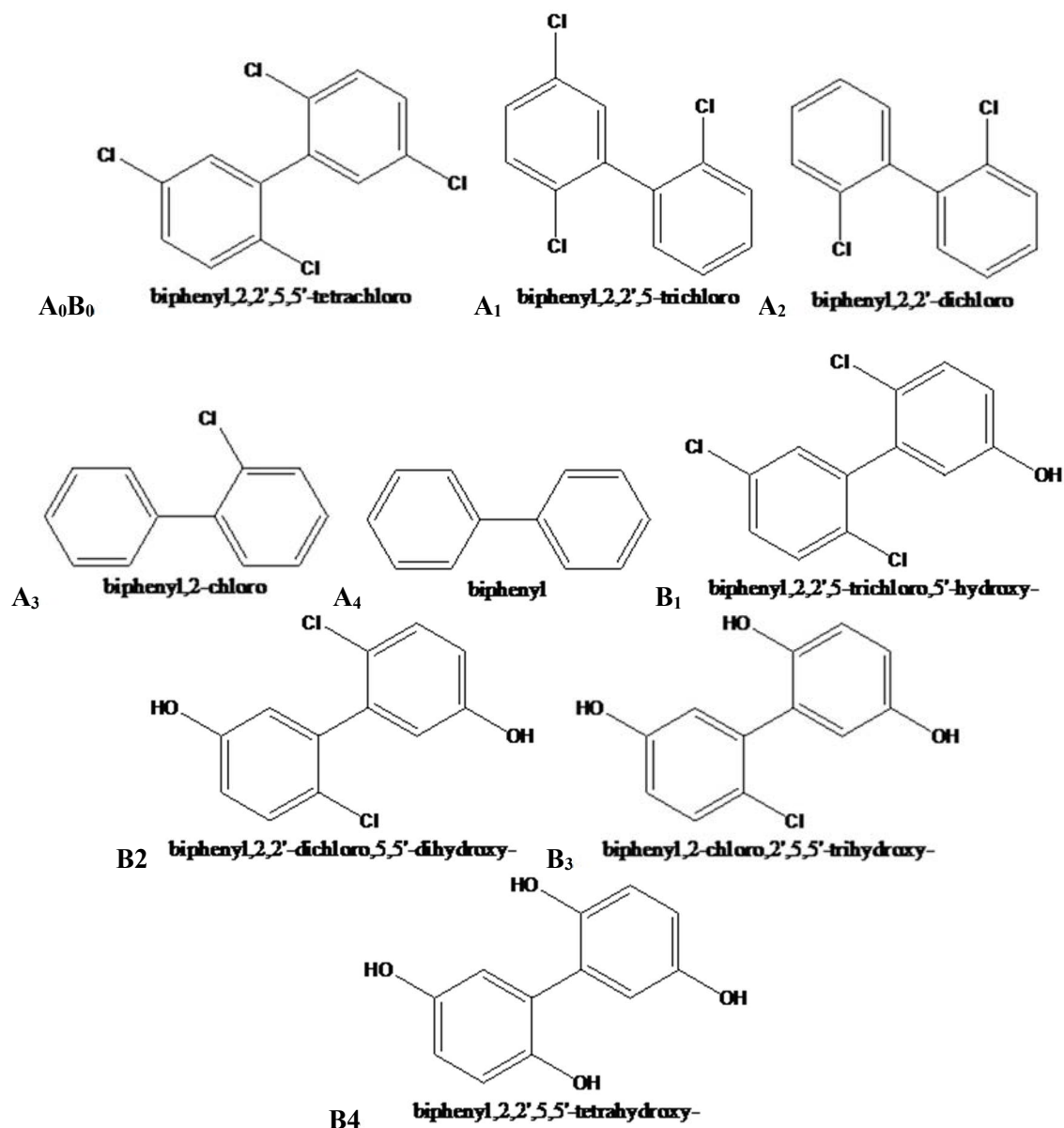

FIG. 4. Molecular structures of proposed radiolysis products formed by reaction mechanisms: A) with solvated electron (A₁ ÷ A₅); and B) with hydroxyl radical (B₁ ÷ B₄).

The GC/MS screening in SCAN mode was unable to evidence the presence of proposed persistent -organic pollutants radiolysis products formed by successive attacks either with solvated electron (Fig. 4, proposed molecular structures A₁÷A₄), either with hydroxyl radical (Fig. 4, proposed molecular structures B₁÷B₄). This may be also because the mass spectrometer sensitivity in SCAN mode is almost 100 times lower than in SIM mode.

3.8. Feasibility study

Through the experience gathered in the 15 years from the commissioning of IRASM-Multipurpose Irradiation Facility (IAEA ROM/8/011), the only industrial gamma irradiator in Romania, IFIN-HH proved it can sustain the development of technological irradiation applications and services from the experimental level to industrial level. In the last 15 years, IFIN-HH developed a market in Romania for radiation processing applications of ~4000 m³/year (finished products and materials treated with ionizing radiations).

There are no spectacular developments worldwide concerning gamma irradiators but the technological advancements in the area of electrons accelerators are making it more and more accessible in different fields. Starting from this premises IRASM Center from IFIN-HH decided to make a feasibility study for installing in an existing laboratory building a compact self-shielded electrons accelerator, being considered the perfect tool for proving a new approach: the synergistic application of several technologies or integrating dedicated accelerators directly on the production line of the beneficiary (including environmental applications like wastewater treatment industry). The public perception impact should be positive, because electron accelerators are „green” technologies, no toxic wastes being produced during their operation.

The placement selected for the electrons accelerator for technological irradiation applications is inside the Irradiation Qualification Laboratory - Building no. 50, IFIN-HH headquarters, Reactorului str., No. 30, Măgurele City, Ilfov County. The site is located in the south-western part of Bucharest, 3.5 km away from its outer limit and 10 km away from the city centre. The sanitary protection area for the activities conducted here is a circular forest with a radius of 800 meters. Distance to the main transport facilities: cca. 1 km away from București – Măgurele road; cca. 0.5 km away from Bucharest ring road; cca. 13 km away from A1 highway; cca. 22 km away from A2 highway.

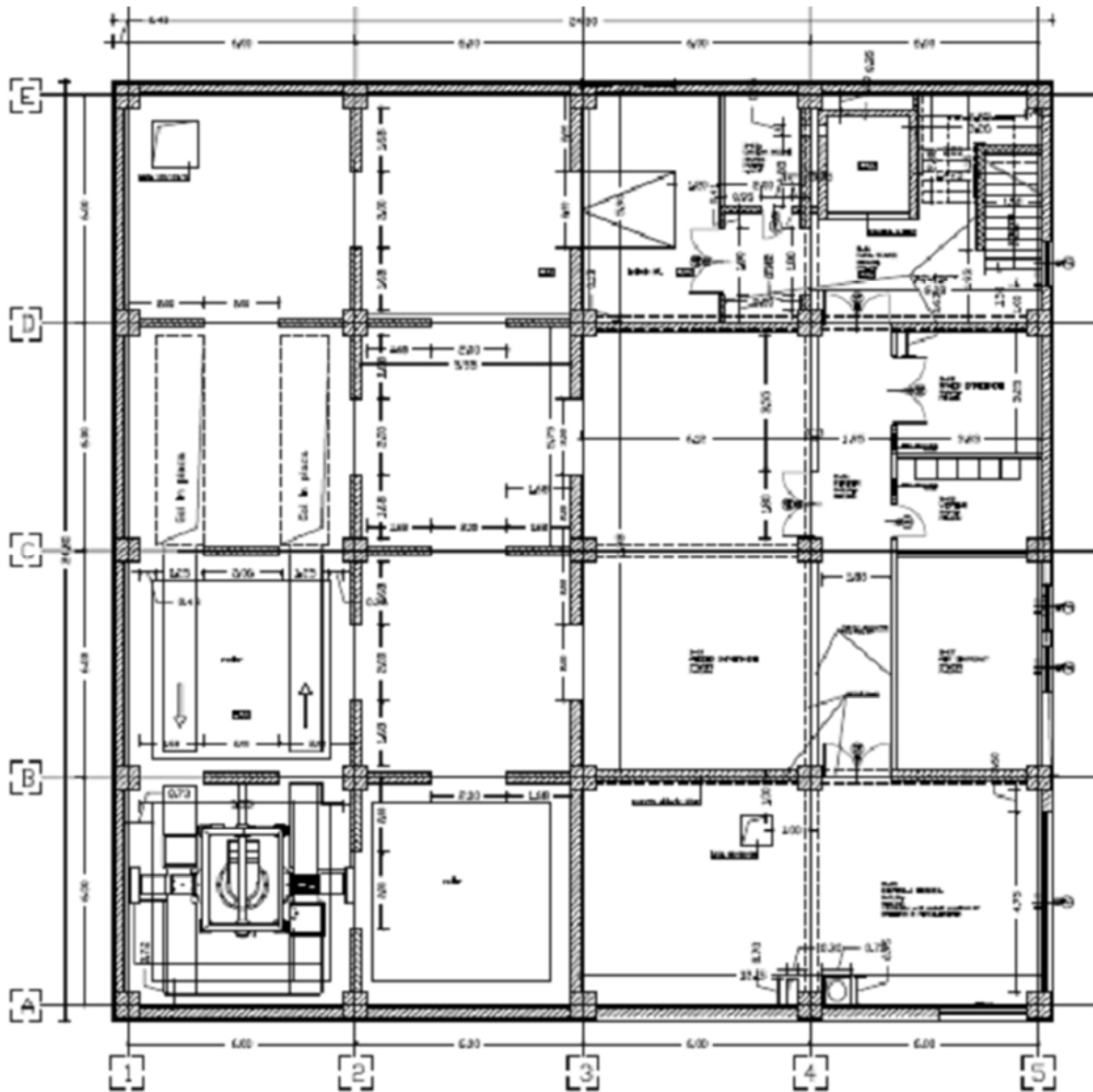

FIG. 5. Upgrading Irradiation Qualification laboratory Building with a self-shielded e-beam accelerator which can be used for demonstration experiments of wastewater effluent treatment.

The upgrading of the "Radiation Qualifying Laboratory" consists of fitting into the existing building a self-shielded electron accelerator (which can be re-located). The self-shielded device has a weight of 50 tons and needs a space in which to operate and a space for maintenance. The space is also required for auxiliary equipment serving the accelerator. The installation of the equipment must be designed to ensure a flow that takes account of the existing laboratory where it is located and its functions. The self - shielded e-beam will be installed in the inoperative basement of the building. The device will be equipped with two conveyors and accessories for demonstrative effluent treatment, also located in the inoperative basement. Making an electron accelerator for technological irradiations at IFIN-HH will enable: Strengthening the contact with the industry and increasing the visibility of nuclear physics in society; Addressing themes of fundamental research and new applied research topics including wastewater, sludge treatment and other environmental applications of radiation processing at IRASM department from IFIN-HH. The proposed solution to cover all present and under development applications was a self-shielded electron accelerator with

6 MeV energy and a power of 12 kW. The need for investment is supported by the following arguments: None of the IFIN-HH accelerators can provide electron beam with the parameters necessary for experimenting applications specific to radiation processing; None of the electron accelerators for radiation technology applications in the country (INFLPR, ICPE-Electrostatica) is any longer in operation; IRASM gamma irradiator reached half of the planned lifespan. The opportunity of investment is given by the following:

Worldwide, there are no spectacular developments for gamma radiation, but technical advances in electron accelerators make these more accessible in various fields. Applying to commercial available machines new technological leaps (e.g. IARC FERMILAB - USA) will allow environmental applications to become technically and economically viable in the next 10 years: "sustainable recovery of resources (water, sediment, SO_x, NO_x etc.)," almost non-existent at the moment internationally.

The accelerator may be located in the building no. 50 from IFIN-HH in an area of ~ 300 m², which can be arranged at minimal cost (additional to spaces in existence today) in the basement - ½ of the building.

The project proposal was submitted in the "Large Research Infrastructures" competition of the "National Competitiveness Program" (POC-2015). If the project proposal will be approved, the completion of the consolidation and modernization of the building and the design, manufacture, installation and commissioning of the self-shielded e-beam accelerator is estimated to take 36 months. The budget is estimated to 8.9 million euro, from which a value of 8.3 million euro will be invested in new facilities for R&D applications of technological irradiation (including e-beam and new industrial technological dosimetry laboratory). Other indicators specific to the investment: 2 R&D equipment's with a value over EUR 100 000.00 purchased on the project; 7 R&D equipment's purchased in total on the project; 9 new and existing researchers (full time equivalent jobs) working in departments with upgraded facilities; 5 new researchers (full time equivalent jobs) working in the supported entity.

4. SUMMARY

The above methodology and analytical procedures will help to better assess the usefulness and limitations of GC for routine monitoring and screening of organochlorine pesticides and their by-products in sewer wastewater treated with ionizing radiation, main goal being process efficiency validation. Gamma irradiation experiments enabled us to calculate the dose necessary to decrease 10 times the concentration of organochlorine insecticides and PCBs in spiked sewer wastewater samples. Molecular modelling studies were done to predict the most probable radiolysis products for correlation with the GC/MS results to confirm radiolysis products and speculate preferential radiolysis pathways.

IRASM Department from IFIN-HH made a feasibility study for installing in an existing laboratory building a compact self-shielded electrons accelerator, being considered the perfect tool for proving a new approach: the synergistic application of several technologies or integrating dedicated accelerators directly on the production line of the beneficiary (including environmental applications like wastewater treatment industry). The public perception impact could be positive, because electron accelerators are „green" technologies, no toxic wastes being produced during their operation.

REFERENCES

- [1] ISO 6468, Water quality - Determination of certain organochlorine insecticides, polychlorinated biphenyls and chlorobenzenes - Gas chromatographic method after liquid-liquid extraction, International Organization for Standardization, (1996).
- [2] ISO/ASTM 51538 Practice for use of the ethanol-chlorobenzene dosimetry system, International Organization for Standardization, (2009).
- [3] VIRGOLICI, M., PONTA, C., MANEA, M., NEGUT, D., CUTRUBINIS, M., MOISE, I., SUVAILA, R., TEODOR, E., SARBU, C., MEDVEDOVICI, A., "Thermal Desorption / Gas Chromatography / Mass Spectrometry Approach for Characterization of the Volatile Fraction from Amber Specimens: a Possibility of Tracking Geological Origins", J. Chromatogr, A **1217(12)** (2010) 1977–1987.

RADIATION INDUCED TREATMENT OF ORGANIC POLLUTANTS

E. ERGUN¹, Ö. KANTOĞLU, M. İNCE² H.T. ERGÜDER³, F.B. DİLEK³

¹Turkish Atomic Energy Authority, Sarayköy Nuclear Research and Training Center, Ankara

²Yıldız Technical University, Environmental Engineering Dept., İstanbul

³Middle East Technical University, Environmental Engineering Dept., Ankara
Turkey

Abstract

In this present research, high strength effluents of Opium Alkaloid Plant located in Afyon Province of Turkey was investigated for its biological treatability combined with radiation processing, as its treatment has been standing problematic for years due to complex structural compounds contained. The aim of this study was to investigate the aerobic biological treatability of opium alkaloid industry wastewaters in conjunction with irradiation as means of pre-treatment in order to make a comparison of feasibility of the radiation and conventional treatment technology.

In this regard, optimization of the anaerobic digestion parameters in pilot scale were studied both for irradiated or non-irradiated wastewater. Up flow sludge blanket reactors (UASB) were set up for these purposes. In the reactors, COD was kept 26000 mg/L due to the inhibition of anaerobic bacteria over this COD content. Domestic wastewater was merged to opium production plant wastewater in the treatment facility in the range of 30–40%. After merging, the COD content was around 18000 – 26000 mg/L. Therefore, further improvement studies of the wastewater treatment were carried out up to this COD content. Total COD reduction of anaerobic digestion of irradiated wastewater was 4500 mg/L from 24750 mg/L with a treatment efficiency of 82%, whereas 58% for non-irradiated. When total cost of treatment was compared with conventional treatment, it was found to be 1.22 and 0.76 USD/m³ for conventional and radiation treatment, respectively.

1. OBJECTIVE OF THE RESEARCH

The main objective of the research was to investigate the anaerobic biological treatability of opium alkaloid industry wastewaters in conjunction with irradiation as a means of pre-treatment to the acceptable COD level of aerobic digestion (5000 mg/L) and tasks carried out during frame time of the research were dose rate effect, required dose for mineralization, anaerobic digestion studies of the radiation treated and non-treated waste water with UASB reactors, process optimization studies, toxicological evaluations of irradiated/non-irradiated and treated /untreated wastewater, and feasibility study.

2. INTRODUCTION

Opium alkaloid industry produces mainly morphine to be used in medical field. Licensed opium poppy cultivation for medical purposes currently takes place in 12 countries around the world. The four main producers are India, Australia, Turkey and France. Opium Alkaloid Plant in Afyon, Bolvadin produces around 30% of global morphine production. Consequently, alkaloid industry is important for Turkey from financial and prestigious point of view. Effluent generated from alkaloid extraction and processing is on average 480 m³/day. The average hourly flow rate of the wastewater is about 20 m³/h. The effluent is discharged to Eber Lake through Akarçay River. Total wastewater to be discharged together with domestic wastewater is about 860 m³/day.

The wastewater generated by the opium alkaloid industry is heavily polluted with very high COD and BOD₅ content, and have intense dark brown colour. Colour causing substances in wastewater are almost totally dissolved and resistant to biodegradation. The pollutant constituents in alkaloid wastewater mainly consist of morphine, codeine, thebaine, papaverine, noscapine, protopine, laudonosine, wax-like substances and cellulose (Fig. 1). Several industrial and academic environments have been concentrated on the treatment of investigated industry wastewater. However, none of them have been succeeded to treat it yet for several reasons. Considering the discharge standards and those of high operating costs, it is necessary to investigate an emerging treatment method or to find the most appropriate combined method. On the other hand, information on characteristics, treatment and disposal of effluents from opium alkaloid industry is quite limited and makes it challenging [1-5].

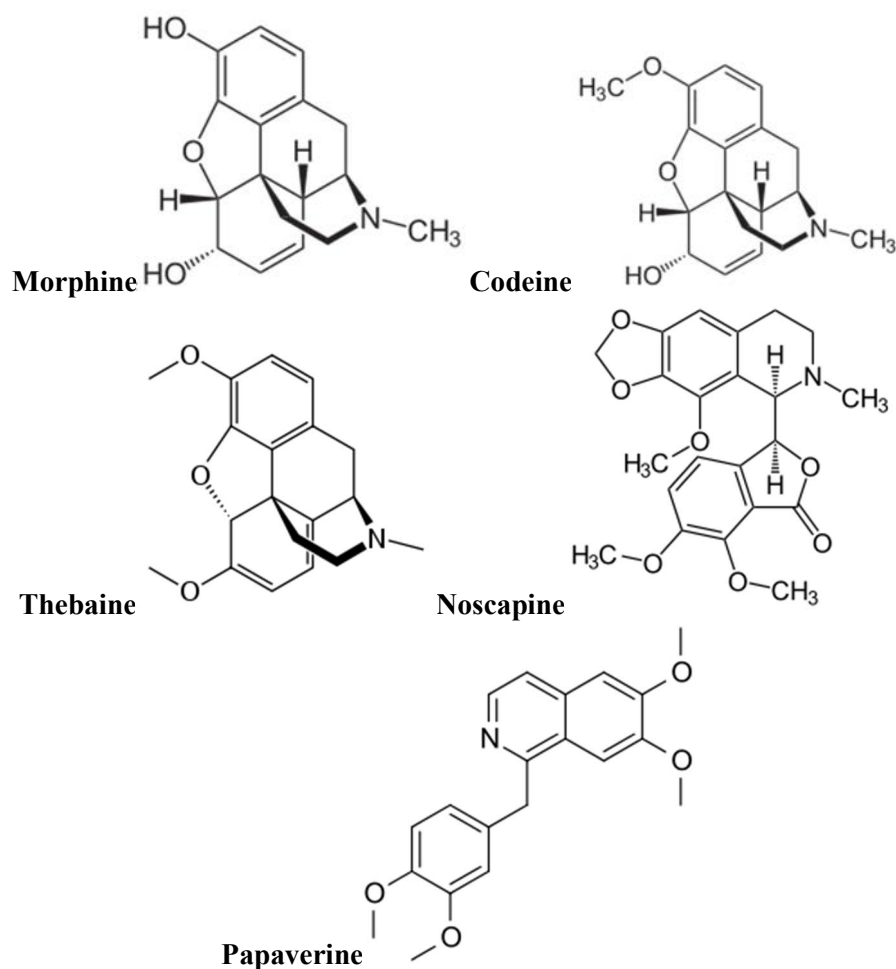

FIG. 1. Major contaminants of alkaloid wastewater.

3. MATERIALS AND METODS

High volume of wastewater was irradiated at ambient atmosphere and temperature at the industrial scale gamma irradiation facility with a dose rate of 2 kGy/h. The anaerobic bacterial granules used in this study were supplied by Frito Lays Potato Chips production plant. Mixed aerobic cultures, which will be used in aerobic digestion studies, were obtained from aerobic sludge digesters of the Greater Municipality of Ankara Tatlar Domestic Wastewater Treatment Plant.

4. RESULTS AND DISCUSSION

4.1. Dose rate effect

Dose rate especially irradiation under air atmosphere is an important phenomena for degradation of organic compounds. Therefore, samples were irradiated at two different dose rates namely 0.67 and 2 kGy/h to better understanding of the dose rate effect on the opium industry wastewater contaminants. Standard solutions of morphine, codeine, thebaine, papaverine and noscapine, which were the main contaminant source of wastewater were prepared at 10 ppm and exposed to gamma rays to deliver gamma rays into these two dose rates. In the result, the dose of complete mineralization was found to be 10 and 30 kGy for low and high dose rate, respectively. Despite the same by-product formation, the required dose was reduced from 30 to 10 kGy by just changing the dose rate from 0.67 to 2 kGy/h. On the other hands, this reduction in required absorbed dose improves the treatment time of period and irradiation volume capacity. Another words, it directly improves the feasibility of the treatment process.

4.2. Determination of dose required for mineralization

Effective dose is another important phenomena as much as the dose rate. In this regard, samples were irradiated to 0, 1, 2, 3, 5, 7, 10, 20, 30, 50, and 80 kGy at a dose rate of 2 kGy/h. Then effective dose required for complete mineralization of contaminants in water, water/methanol (50/50%; v/v %) and methanol solution was investigated and determined by LCMS. Poppy seeds were extracted in opium processing plant by using two different extraction techniques using solvents of water and methanol. It was therefore, irradiation was carried out in these environments to simulate the actual conditions and analysed by LCMS to better understanding of degradation mechanism and the effective dose for over 95% of mineralization. Results were summarized in Table 1.

TABLE 1. NECESSARY DOSE IN DIFFERENT ENVIRONMENTS TO DISINTEGRATE OVER 95% OF THE CONTAMINANTS IN OPIUM INDUSTRY WASTEWATER (DOSE RATE: 2 kGy/H)

Contaminant	Water (kGy)	Water/Methanol (kGy)	Methanol (kGy)
Morphine	NS	10	10
Codeine	1	7	10
Thebaine	NS	3	10
Papaverine	1	3	3
Noscapine	1	5	10

NS: non-soluble

As revealed in Table 1, the required dose for mineralization were varied from 1 to 10 kGy for all solvent compositions used in the extraction. But 10 kGy was accepted as optimum dose to make sure the achievement of over 95% mineralization. The results on degradation mechanism in methanol solution was published elsewhere [6, 7] and others are being prepared for publications.

4.3. Pre-treatment with Ion Exchange Resin

Alkaloid wastewater contains positive and negative charged molecules in original form. In addition to that, after irradiation (10 and 40 kGy) new charged molecules were generated. In this regard, these charged molecules were removed by using mix (anionic and cationic) ion exchange resin and results of COD and colour (Pt-Co) change were summarized in Table 2

TABLE 2. CHANGE IN COD AND COLOR CHARESTICS OF 0, 10 AND 40 kGy IRRADIATED ALKALOID WASTEWATER AFTER PRE-TREATMENT WITH MIX ION EXCHANGE RESIN

	0, 10 and 40 kGy irradiated alkaloid wastewater characteristics			0, 10 and 40 kGy irradiated alkaloid wastewater characteristics After pre-treatment with Ion Exchange Resin		
	0 kGy	10 kGy	40 kGy	0 kGy	10 kGy	40 kGy
Colour (Pt-Co)	6240	4820	4120	1740 (72%)	1380 (55%)	1720 (38%)
COD	24960	25660	27640	7900 (68%)	9380 (65%)	25700 (8%)

As could be seen from Table 2, COD and colour of non-irradiated and irradiated wastewater after pre-treatment with ion exchange resin were significantly changed (Fig. 2). Results showed that ion exchange resin could be used for pre-treatment for both wastewater. However, reusability of ion exchange resin was very limited and made it unfeasible in terms of cost and practicability. On the other hand, this result also showed that any pre-treatment, which was cost effective and practical, could be applied.



FIG. 2. Colour differences between pre-treated and npn-treated wastewater by ion exchange resin.

4.4. Anaerobic biodegradability

After having the promising results in laboratory scale experiments, the treatment system was scaled up to pilot scale and worked on several treatment models to reach the discharge criteria. Direct radiation effect on the COD reduction of opium alkaloid wastewater was limited and was around 5% determined by laboratory and pilot scale experiments. In this regard, radiation technology was used as combined treatment method and its results were compared with non-irradiated wastewater treatment results. On the other hand, to improve the treatment efficiency by using radiation, irradiation position was changed and compared with those of non-irradiated treatment results. At this point, several treatment models were studied. These models were;

- 1) Aerobic + Anaerobic

- 2) Aerobic + Irradiation + Anaerobic
- 3) Irradiation + Aerobic + Anaerobic
- 4) Anaerobic
- 5) Anaerobic + Irradiation
- 6) Anaerobic + Anaerobic
- 7) Irradiation + Anaerobic + Anaerobic
- 8) Anaerobic + Irradiation + Anaerobic
- 9) Anaerobic + Anaerobic + Irradiation
- 10) Irradiation + Anaerobic

Models of 1–3 starts with aerobic digestion. However, it is difficult to work with aerobic digestion process over 5 g/L COD content in practical terms especially at pilot and industrial scale [8]. In addition, foam formation was observed when dissolved oxygen concentration was kept at 2 mg/L. Regarding to these observations, biological treatability studies were initiated with anaerobic digestion process rather than aerobic process to reduce COD content to the acceptable limit of aerobic process (5 g/L) treatment.

Bacterial inhibition at UASB reactors was observed over 26 g/L COD content at pilot scale experiments as observed in the lab scale experiments. It was thought that the inhibition might be caused by the high sulphate concentration. Bacterial digestion in anaerobic process always undergoes reduction reaction. Therefore, if complete mineralization is observed, sulphate is first converted to sulphide and then hydrogen sulphur. However, if partial mineralization is occurred, reactor will be rich in sulphide. Sulphide may be considered to be an important inhibitory compound due to its toxic effect on the methanogens. According to Speece, sulphide concentrations in the range of 100 to 150 mg.L⁻¹, at a pH of 6.8, may lead to severe inhibition of methanogenesis [9]. Koster found that a free hydrogen sulphide concentration of 250 mg.L⁻¹ led to 50% inhibition in the pH range 6.4 to 7.2 [10]. Sulphide concentration was followed day by day to determine the contribution to inhibition. It was found to be in between 0.1 to 2 mg/L in anaerobic digestion process. It was concluded that the sulphide formation was not responsible from this inhibition.

Opium alkaloid wastewater contains high sulphate concentration. Sulphate must also be removed as well as COD from wastewater. Therefore a proper treatment model has to be applied and both pollutants must be removed. In this regard, two UASB reactors were operated sequentially as in some of the treatment models like 6–9. Biomass in anaerobic reactors contains both carbon and sulphur reducing bacteria. Depending on the feeding conditions, one of them is dominant, the other is recessive. But both bacteria cultures are active and reduce the carbon and sulphur containing organic compounds. First UASB reactor was acclimated gradually with opium alkaloid wastewater to increase carbon reducing bacteria content. Then second reactor was acclimated with the highest COD content wastewater to inhibit the carbon reducing bacteria. So sulphur reducing bacteria will be the dominant in the second reactor. Once both reactors reached to steady state, reactors were operated sequentially to treat both pollutants at one process. The results obtained for the models of 4–10 were summarized in Table 3.

TABLE 3. ANAEROBIC TREATMENT EFFICIENCY PERCENTAGE OF EACH TREATMENT MODEL

Treatment Model		Treatment Efficiency %			
Number	IR	ANA	IR	ANA	IR
4	NA	58 (11 g/L)	NA	NA	NA
5	NA	58 (11 g/L)	5 (10.4 g/L)	NA	NA
6	NA	70 (7.7 g/L)	NA	48 (4 g/L)	NA
7	5 (24.7 g/L)	64 (8.7 g/L)	NA	49 (4.9 g/L)	NA
8	NA	70 (7.7 g/L)	5 (7.3 g/L)	48 (3.8 g/L)	NA
9	NA	70 (7.7 g/L)	NA	48 (4 g/L)	5 (3.8 g/L)
10	5 (24.7 g/L)	77 (4.5 g/L)	NA	NA	NA

NA: This step is not available in this model, IR: Irradiation, ANA: Anaerobic treatment

As could be seen from Table 3, as if wastewater was treated to the acceptable level of aerobic digestion process in some models like 6–9, effluents of these models could not be the influent of aerobic digestion process. Instability of biomass during the operating of UASB reactors and high non-biodegradable COD content made these models inapplicable. In addition, operating of two UASB reactors were not cost effective when compared with one UASB reactor model. When treatment model was shifted from 9 to 10, a promising result was obtained (Table 3). Continuous UASB reactors were operated and fed with irradiated (Model 10) and non-irradiated (Model 4) wastewater to demonstrate the advantage of the radiation application.

Organic loadings and treatment efficiencies data collected from Model 10 and Model 4 were presented at Figs. 3A and B, respectively. Figs. 3A and B revealed that the stability of biomass response to gradually increased organic load and high treatment efficiency at 26 g/L COD were achieved at Model 10 rather than the other treatment models. In addition to the best treatment efficiency, cost effectiveness and stable operation conditions were other important benefits of Model 10. Sulphate reduction was also examined and found to be 70% (from 10000 ppm to 3000 ppm) reduction.

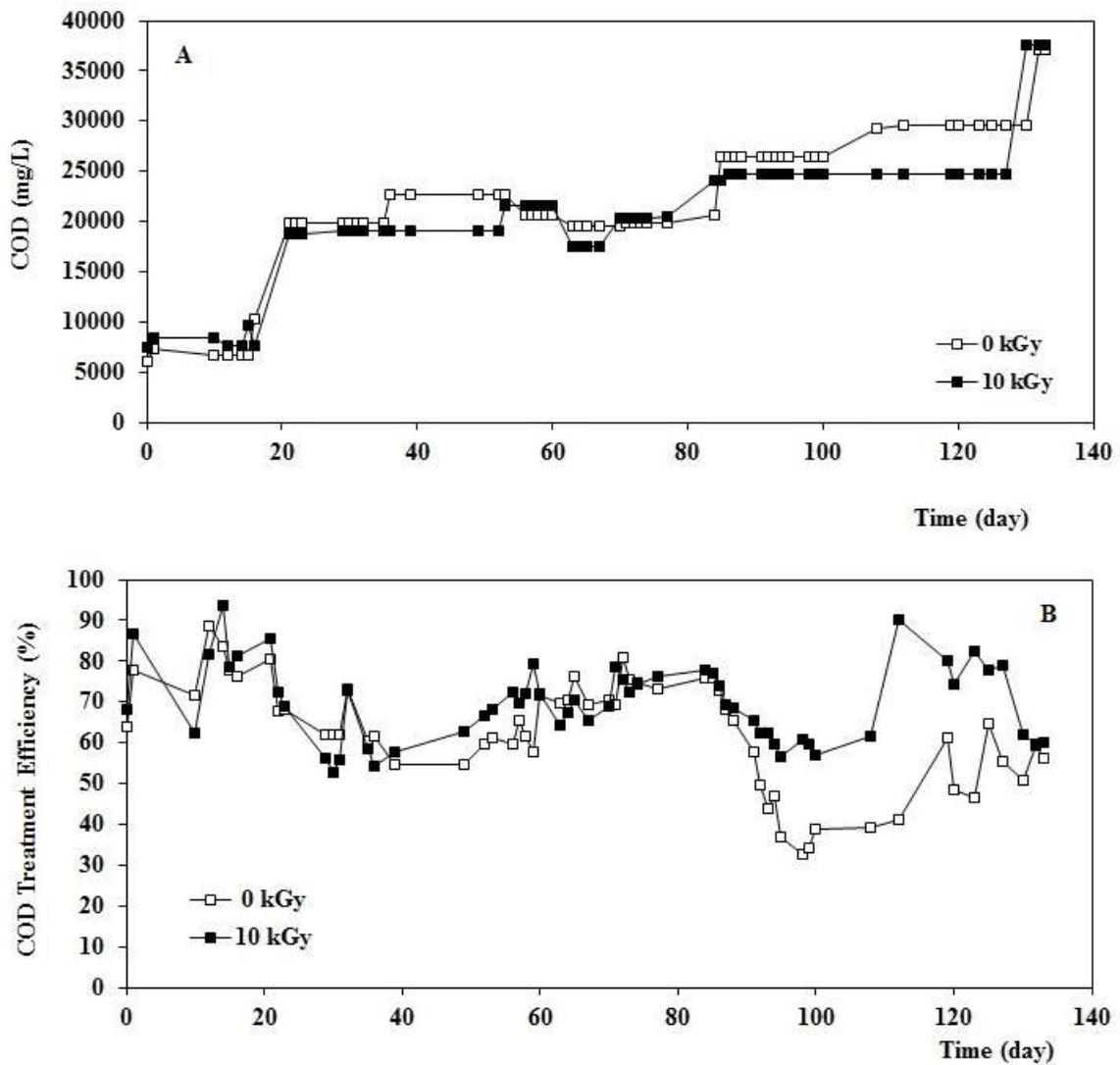

FIG. 3. Graph of organic load (A) and treatment efficiency (B) of UASB reactors versus time for irradiated (Model 10) and non-irradiated wastewater (Model 16.4).

After new wastewater taken from Opium Alkaloid Processing Plant, some interesting results were observed at the wastewater which had never been observed before. The most important observation was instantly COD reduction in the storage tanks. This observation was followed and tabulated in Table 4. As revealed in Table 4, initial COD was drastically reduced from 26000 to 7400 mg/L in 35 days for non-irradiated wastewater, whereas from 21000 to 8500 mg/L in 3500 days for 10 kGy irradiated wastewater. After treatment with UASB reactors, these influents COD values were reduced to 2300 and 3500 mg/L for non-irradiated and irradiated wastewater, respectively. Both results were under the acceptable limit of aerobic digestion (5000 mg/L). This current situation was attributed to a microbial

contamination of non-irradiated wastewater before or during collecting of wastewater from Opium Alkaloid Processing Plant.

TABLE 4. CHANGE OF INFLUENT COD IN TIME

Time (day)	Inf. COD (g/L) 0 kGy	Effl. COD (g/L) 0 kGy	Inf. COD (g/L) 10 kGy	Effl. COD (g/L) 10 kGy
0	26	-	21	-
3	13	5.8 (55%)	16	7.5 (53%)
13	10	3.6 (64%)	14	6.9 (50%)
28	8	3.9 (51%)	10	3.9 (61%)
35	7.4	2.3 (69%)	8.5	3.5 (59%)

As depicted from Table 4, total COD reduction between influents and effluents was 26000 to 2300 mg/L with a reduction of 91% for non-irradiated wastewater, whereas 21000 to 3500 mg/L with a reduction of 84% for 10 kGy irradiated wastewater.

4.5.G values and destruction efficiency

In order to quantify the radiation chemical effects of ionizing radiation, the amount of molecules transformed or produced and quantities of absorbed radiation energy that cause this effect have to be known. The ratio of the two is called radiation chemical yield and described in terms of G-values according to the following equation [11, 12]:

$$\text{Radiation-chemical yield, } G(\text{product}) (\mu\text{mol J}^{-1}) = 10^6 \times \text{chemical yield (mol kg}^{-1}\text{) absorbed dose (Gy)} \quad (1)$$

In this study, the concentrations of morphine and codeine in irradiated samples were calculated based on the intensity values in the mass spectra. Intensities of non-irradiated morphine and codeine solutions were found to be 50585056 (0.0350 mmol/L) and 49526176 (0.0344 mmol/L), respectively. Based on the intensity values of non-irradiated morphine and codeine, the alkaloid concentrations of irradiated solutions at doses of 10, 20 30, 40 and 50 kGy were calculated as 0.0293, 0.0244, 0.0180, 0.0076, 0.0039 mmol/L for morphine and 0.0296, 0.0228, 0.0158, 0.0047, 0.0007 mmol/L for codeine, respectively.

The concentration differences of non-irradiated and irradiated morphine and codeine were evaluated as the amount of molecules destruct and/or transformed into by-products. G values of morphine and codeine radiation induce destruction were determined through drawing the graph of alkaloid concentration difference as a function of absorbed dose values. G-values of the alkaloids were determined by the slope of these linear curves and found to be -0.18 and $-0.21 \mu\text{mol/J}$ for morphine and codeine, respectively. However, concentrations and G values of by-products could not be determined due to the lack of standard chemicals. In this regard, to get a better idea about radiation-induced formation and destruction efficiency, intensities of alkaloids and by-products obtained from mass spectra were plotted against absorbed dose values (Fig. 4a and b). Fig. 4a and b clearly reveal that intensities of the by-products were increased in the dose range between 10 to 40 kGy. However, all molecules exposed to doses above 40 kGy were efficiently degraded by the high-energy irradiation. Destruction efficiency

of both alkaloids was calculated at 10, 20, 30, 40, and 50 kGy and it was found to be 16, 30, 49, 78, 89% for morphine and 12, 32, 53, 86, 98% for codeine.

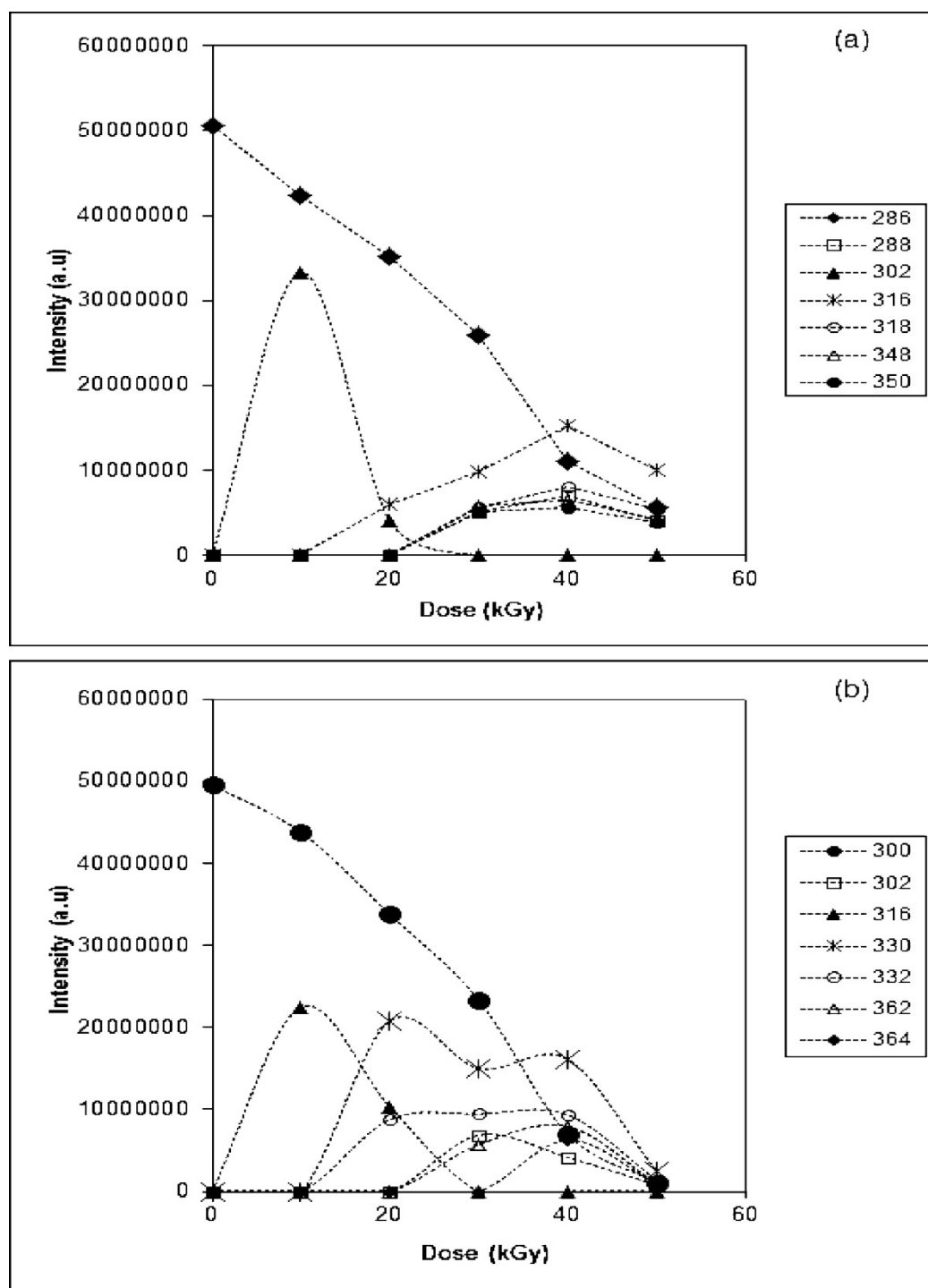

FIG. 4. Radiation-induced formation of by-products and destruction efficiency of alkaloids and by-products as a function of absorbed dose (a) morphine, (b) codeine.

Methoxy and hydrogen adducts were detected in lower amounts than oxygenated by-product of thebaine at doses between 1 and 5 kGy (Fig. 5). In the presence of oxygen, methoxy and hydrogen radicals are converted to less reactive peroxy transients [13, 14]. On the other hand, oxygen consumption and large amount of methoxy and hydrogen radical formation at dose

values higher than 5 kGy led to an increase in radical adduct concentration. These adducts were observed at m/z 344, 360, 374 and 376 in the mass spectra of irradiated thebaine.

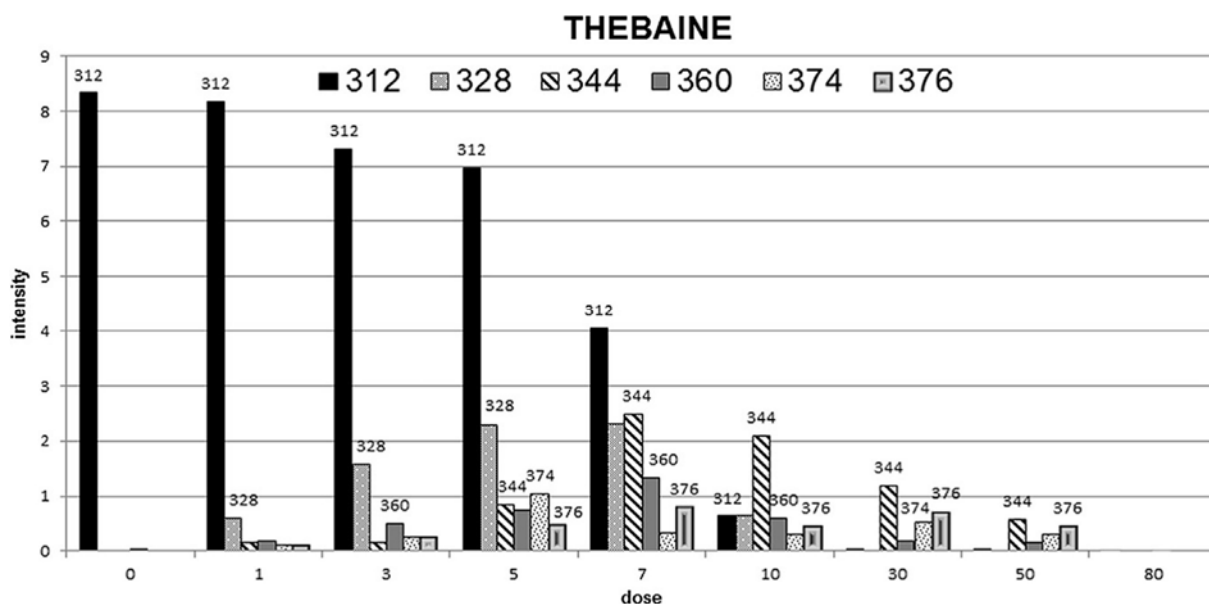

FIG. 5. Intensities of thebaine and by-products as a function of absorbed dose.

All by-products were observed at dose of 3 kGy for papaverine. The amount of these by-products was significantly decreased with increasing dose values (Fig. 6). Ion at m/z 268 was the most resistant by-product to gamma radiation. However, all by-products were degraded at doses above 50 kGy.

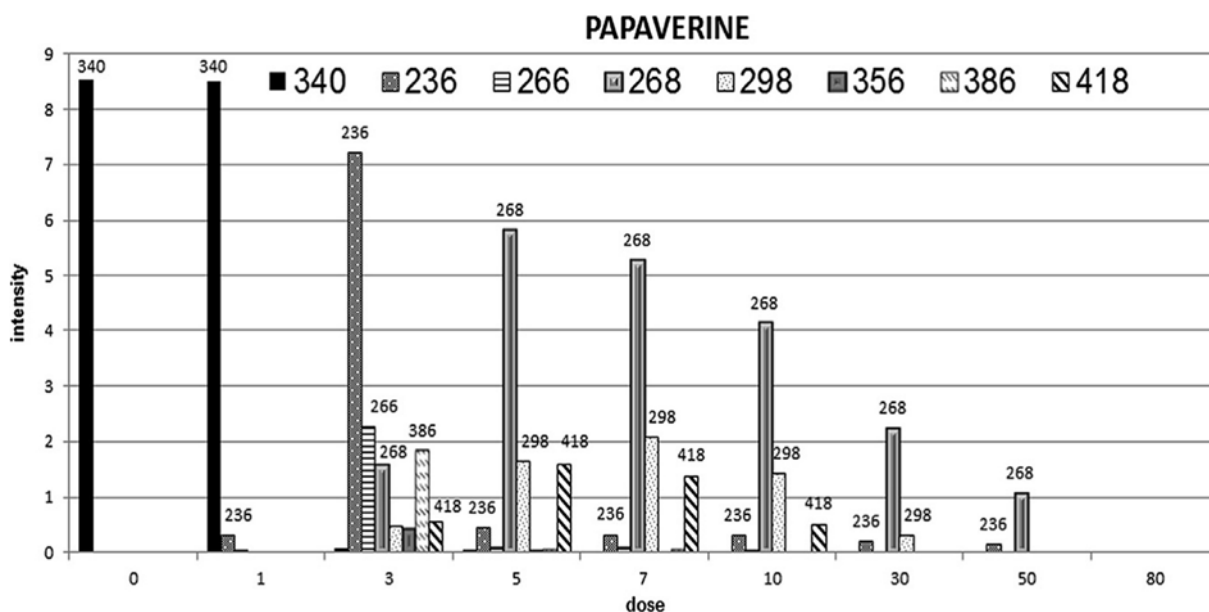

FIG. 6. Intensities of papaverine and by-products as a function of absorbed dose.

In the noscapine degradation studies, results showed that irradiation at 3–10 kGy destroyed almost all noscapine and induced formation of by-products (Fig. 7). Destruction of by-products was virtually completed after an absorbed dose of 50 kGy. At doses above 50 kGy it

was observed that by-products were radiolyzed into smaller compounds and these compounds were found as main products in irradiated samples.

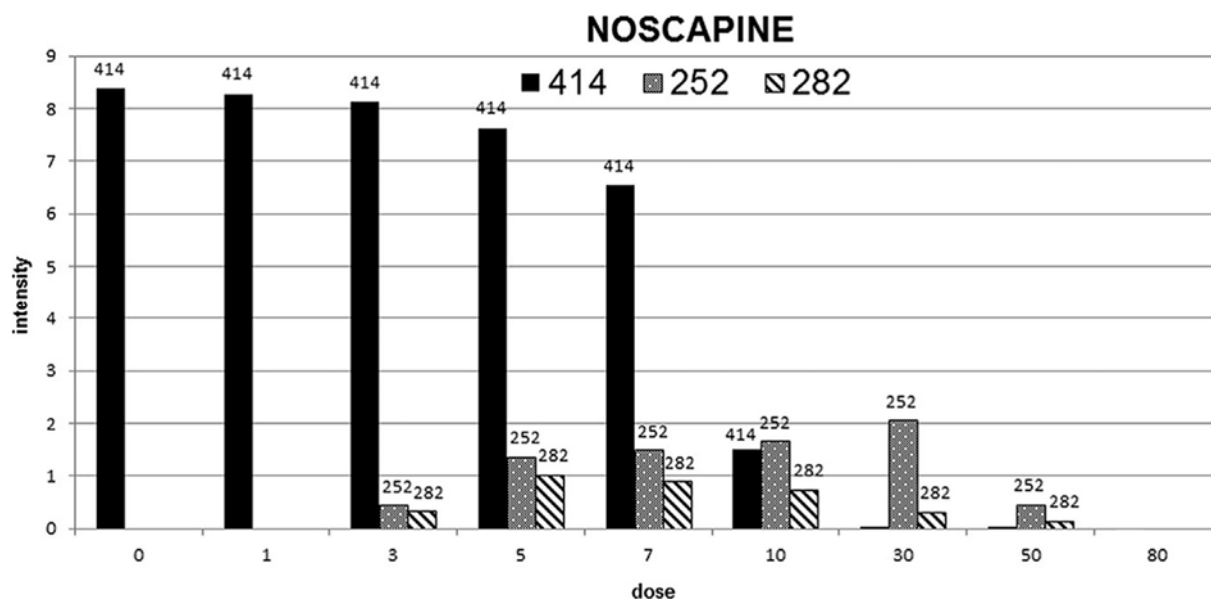

FIG. 7. Intensities of noscapine and by-products as a function of absorbed dose.

As could be seen from the degradation studies, all major pollutants were mineralized at 10 kGy. However, by-products of those pollutants were needed to be irradiated up to 50 kGy for complete mineralization.

4.6. Feasibility Study

When based on data of existing treatment plant, the total cost of treatment has been calculated to be 1.22 USD/m³ including chemical and biological treatment. This cost includes running cost and operation cost, which are about 0.88 and 0.34 USD/m³, respectively. In addition, treatment of alkaloid wastewater by using radiation technology has also been evaluated and total cost of treatment has been found to be 0.76 USD/m³ including radiation and biological treatment. Running and operation costs of the radiation treatment system combined with biological treatment have been calculated to be 0.53 and 0.23 USD/m³. In the calculation, total volume of wastewater per day, absorbed dose to be delivered and efficiency of e-beam irradiator (10 MeV, 10 kW) have been taken into account as 1000 m³/day, 10 kGy and 0.6, respectively. This result shows that around 38% of capital advantage per m³ of treated wastewater has been achieved by radiation technology combined with anaerobic and aerobic treatments regarding to conventional treatment process.

5. CONCLUSION

Radiation treatment of alkaloid wastewater combined with biological treatment was performed in the level of laboratory and then pilot scale. After promising results from laboratory experiments, pilot scale experiments were done and it was treated to the acceptable limit of aerobic digestion with 82% of efficacy from 24.7 g/L to 4.5 g/L by using radiation and anaerobic treatment (UASB). On the other hand, the treatment cost of alkaloid wastewater were compared with the conventional treatment process and found to be 38% capital advantage while the conventional and radiation treatment cost were 1.22 and 0.76 USD/m³, respectively.

ACKNOWLEDGEMENT

Authors wish to express their gratitude to both Turkish Atomic Energy Authority (TAEK-A3.H2.P3.03) and International Atomic Energy Agency (CRP-16406), which financially supported this work.

REFERENCES

- [1] SEVIMLI, M.F., AYDIN, A.F., SARIKAYA, H.Z., OZTURK, I., Characterization and Treatment of Effluent From Opium Alkaloid Processing Wastewater. *Wat. Sci. Technol.* **40(1)**, (1999) 23–30.
- [2] AYDIN, A.F., ALTINBAŞ, M., SEVIMLI, M.F., Öztürk, I., Sarıkaya, H.Z., Advanced treatment of high strength opium alkaloid industry effluents. *Wat. Sci. Tech.*, **46(9)**, (2002). 323–330.
- [3] AYDIN, A.F., Afyon Alkaloidleri Endüstrisi Atıksularının Biyolojik Prosesler ve Fenton Oksidasyonu ile İleri Arıtımı. Ph. D. Thesis, İstanbul Technical University, İstanbul. (2002)
- [4] KAÇAR, Y., ALPAY, E., CEYLAN, V.K., Pretreatment of Afyon Alkaloid Factory's Wastewater by Wet Air Oxidation (WAO). *Wat. Res.*, **37**, (2003) 1170–1176.
- [5] KOYUNCU, I., An Advanced Treatment of High-Strength Opium Alkaloid Processing Industry Wastewaters with Membrane Technology: Pretreatment, Fouling and Retention Characteristics of Membranes. *Desalination*, **155**, (2003) 265–275.
- [6] ERGUN. E., KANTOĞLU, Ö., Degradation of Morphine and Codeine by Gamma Radiation in Methanol Solution. *Radiochimica Acta*, **103 (2)** (2015a) 137–147.
- [7] ERGUN. E., KANTOĞLU, Ö., Radiation Induced Destruction of Thebaine, Papaverine and Noscapine. *Rad. Phys. Chem.* (2015b) <http://dx.doi.org/10.1016/j.radphyschem.2015.10.013i>.
- [8] TCHOBANOGLIOUS, G., BURTON, F.L., STENSEL, H.D.,. *Wastewater Engineering: Treatment and Reuse*. Metcalf & Eddy. Inc., McGraw Hill, (2003) New York.
- [9] SPEECE, R:E.,. *Anaerobic Biotechnology for Industrial Wastewater Treatment*. *Env. Sci. Tech.* **17(9)**, (1983) 416A–427A.
- [10] KOSTER, I.W., RINZEMA, A., DE VEGT, A.L., LETINGA, G., Sulphide Inhibition of The Methanogenic Activity of Granular Sludge at Various pH-Levels. *Wat. Res.*, **20 (12)**, (1986) 1561–1567.
- [11] WOODS, R.J., PIKAEV, A.K.: *Applied Radiation Chemistry Radiation Processing*, Wiley, New York (1994).
- [12] VÉRTES, A., NAGY, S., KLENCsÁR, Z., LOVAS, R.G.: *Handbook of Nuclear Chemistry*, Springer, New York (2011).
- [13] GETOFF, N., Factors influencing the efficiency of radiation-induced degradation of water pollutants. *Radiat. Phys. Chem.*, **65**, (2002) 437–446.
- [14] GUTMAN, D., SANDERS, N., BUTLER, J.E., Kinetics of the reactions of methoxy and ethoxy radicals with oxygen, *J. Phys. Chem.*, **86** (1982), pp. 66–70.

COMBINED ELECTRON BEAM –CHEMICAL OXIDANT TECHNOLOGIES FOR TREATING ORGANIC POLLUTANTS IN MUNICIPAL WASTEWATER: COST-BENEFIT AND BUSINESS MODEL DEVELOPMENT

S.D. PILLAI, R.S. REIMERS

National Center for Electron Beam Research — IAEA Collaborating Centre for Electron Beam Technology

Texas A&M University

United States of America

Abstract

High-energy electron beam (eBeam) irradiation is an effective disinfection technology for wastewater treatment plants. Depending on the eBeam dose, significant reductions of all target organisms is achievable. The conventional view that municipal wastes be treated primarily to prevent the transmission of diseases and prevent environmental impacts is rapidly changing. Sewage sludges are significant pools of water, energy substrates, and nutrients. Water availability is a major challenge facing regions around the world and especially cities and states in the US. Thus, wastewater treatment plants should be viewed as “Sustainable Resource Recovery Facilities” where high value resource recovery operations are performed rather than just locations for the treatment and disposal of municipal wastes. This project focused primarily on the economic analysis associated with eBeam technology adoption in the wastewater industry (sewage sludge and effluent). Major outcomes of this project included engagement with different stakeholders to obtain a clear understanding of the technology and regulatory challenges associated with commercial adoption of this technology by the wastewater industry

1. OBJECTIVE OF THE RESEARCH

With increasing urbanization and resulting population increases, cities around the world have to manage enormous quantities of human wastes [1]. In the United States alone, more than 16 000 waste water treatment plants are in operation today treating around 150 billion litres of waste water per day and generating approximately 5.6 million dry metric tons of treated sewage sludge. The conventional view is that municipal wastes have to be adequately treated to prevent the transmission of diseases and prevent environmental impacts. However, sewage sludges are also significant pools of water, energy substrates, and nutrients as well. Thus, wastewater treatment plants should be viewed as “Sustainable Resource Recovery Facilities” where high value resource recovery operations are performed rather than just locations for the treatment and disposal of municipal wastes [2]. However, for this paradigm-shifting concept to become a reality, it is critically important for the US to identify and nurture technologies that can cost-effectively disinfect, stabilize and generate energy from municipal wastes. There is a compelling need to exploit different technologies to extract as much of the energy and nutrients as possible from different waste-streams. The overall goal of the activities over the course of the CRP was to:

- (1) Obtain empirical information on efficacy of the technology to disinfect sewage sludges,
- (2) Obtain empirical information on the efficacy of the technology to disinfect wastewater effluent
- (3) Perform an in-depth economic analysis of eBeam technology for the wastewater industry
- (4) Work closely with the wastewater industry stakeholders to promote the technology

2. INTRODUCTION

In the United States, the US EPA [3] federally regulates the land disposal of biosolids. This regulation classifies biosolids as either Class A or Class B biosolids based on the level of treatment, pathogen loads, and their potential to attract disease vectors. Class A biosolids undergo a more complete disinfection process with the aid of specific treatment processes referred to as Processes to Further Reduce Pathogens (PFRP). In the United States, the EPA approved PFRP processes are heat treatment, drying, composting, thermophilic aerobic digestion, pasteurization, and ionizing irradiation. Ionizing radiation using either cobalt-60 or electron beam (e-beam) at a minimum dose of 10 kGy is considered as an effective PFRP to produce Class A biosolids. Class A biosolids should contain no detectable pathogens (in specified quantities of biosolids), and is considered safe for environmental disposal without restrictions. However, in Class B biosolids, disinfection is incomplete, and so Class B biosolids will contain detectable levels of pathogens. Consequently, there are strict regulations as to how the Class B biosolids are managed [3]. A pilot-scale low energy e-beam wastewater treatment plant was operational in Florida in the early 90's [4]. The advantage of using e-beam irradiation is that this process is based on commercial electricity, and does not involve the use of radioactive isotopes. Hence issues surrounding radioactive isotopes such as transport, storage, disposal and security are non-existent. In addition to the difference in the source of ionizing radiation between cobalt-60 and eBeam, these two types of ionizing radiation differ in terms of energy (measured in MeV) and dose-rate (measured in grays/minute). The energy profile of the gamma rays from a cobalt-60 source ranges between 1.17 and 1.33 MeV while high energy e-beam is normally around 10 MeV. The dose rate of gamma rays from cobalt-60 is often in the range of hundreds of grays per minute, while in the case of eBeam the dose rate is in the range of tens of millions of grays per minute [5].

3. MATERIALS AND METHODS

3.1. Efficacy of the technology to disinfect sewage sludges

Aerobically and anaerobically digested biosolid samples were collected over multiple days from two different wastewater treatment plants in Texas. The samples were collected directly from the digester. Separate collections were made for different irradiation trials. Moisture content, solids concentration (%), and other basic chemical parameters of the sludge samples were determined. The starting levels of *E. coli*, aerobic and anaerobic spore formers were analysed immediately or within 24 hours of sample collection. The samples had significant levels of *E. coli*, aerobic, and anaerobic spore formers. However, the density of other indicator organisms and specific pathogens were low. Hence, *Salmonella* Typhimurium, coliphages, and enteric viruses had to be spiked into the samples in the laboratory at sufficient titres for the inactivation studies. One set of samples were spiked with high titre of laboratory-grown strains of nalidixic acid and novobiocin resistant *Salmonella enterica* serovar Typhimurium (*S. Typhimurium* -accession # 87-26254, obtained from National Veterinary Service Laboratory, Ames, Iowa). Similarly, the samples were spiked with *E. coli* phages, ϕ X174 (ATCC #13706-B1) and MS-2(ATCC #15597-B1) and Enteric viruses, Poliovirus-1 (VR-1562) and Rotavirus (SA-11). The bacterial pathogen was grown to high titres using an overnight culture which was then centrifuged and washed multiple times to remove media components. The washed cells were then re-suspended in sterile phosphate-buffered saline (PBS) prior to sample seeding. The titre of the inoculum was quantified. For the phages and enteric virus samples, the high titres were prepared and quantified using standard protocols. Each of these microorganisms was spiked into separate samples to facilitate accurate quantification. The eBeam irradiation trials were performed in special containers to facilitate

uniform dose distribution. The samples after irradiation were enumerated per standard protocols.

3.2.Efficacy of the technology to disinfect wastewater effluent

Tertiary treated water samples from two wastewater treatment facilities in Texas were spiked with varying levels of bacterial and viral pathogens, and exposed to varying doses of eBeam irradiation. After exposure, the number of survivors was determined. Based on the surviving population, the inactivation kinetics (log₁₀ reduction levels) was determined. These studies have helped delineate the eBeam dose that would be required to achieve defined reductions of the different pathogens at varying doses. Similarly, the water samples were spiked with varying concentrations of estrogenic compounds and varying doses were employed to determine whether eBeam technology would be capable of destroying the estrogenic activity. Additionally, studies were performed to determine whether eBeam irradiation would be able to reduce toxicity associated with aquatic samples.

3.3.Economic analysis of EBeam technology for the wastewater industry

The objective for the research phase of this study was to find economic reports and cost comparisons for biosolids disinfection and stabilization technologies. Research was conducted by two methods. The first method was a literature survey of the papers and proceedings from the Water Environment Federation (WEF) conferences occurring after 2008. A cursory internet search was also conducted. The other method involved direct correspondence with manufacturers of biosolids treatment technologies and with biosolids management experts. During this correspondence specific information regarding capital costs and operation and maintenance (O&M) costs for different treatment technologies was obtained. In addition to researching the costs of alternatives, the potential costs of the eBeam process in order to accurately compare all economic benefits. For applications in the municipal wastewater treatment industry we assumed that this technology would have to be used in a 10 MGD (million gallons per day), 50 MGD, or a 90 MGD facility. A rule of thumb is that a 1 MGD plant serves a population of about 10 000. These throughput volumes represent cities that have populations of 100 000, 500 000 and 900 000. This was based on the economic reality that only facilities of this magnitude would be able to afford the technology. For application that involved the treatment of sludges, we assessed the economics of the eBeam process in making stable, Class A biosolids and compared it to other contemporary technologies that also achieve advanced biosolids stabilization and disinfection. For the economic analysis, we relied upon a variety of resources. These included previously published technical reports and consultation with leading accelerator manufacturers and system installers. We compared eBeam technology to five different Class A type disinfection and stabilization technologies. These technologies are all utilized in different ways and at different commercial scale treatment plants in the US. Company names and other identifying descriptors have been avoided for confidentiality and proprietary reasons. For the economic analysis we used an annual amortized payment plan at 8% interest over a 15-year plant lifespan. This was used in calculating the total capital costs. The total capital costs was added to the operation and maintenance costs and then summed value was divided by the dry tons per year to arrive a total cost per dry ton.

3.4.Engage the wastewater industry stakeholders to promote the technology

We used a multi-pronged approach of engaging the wastewater industry. We presented technical papers at industry specific conferences such as WEFTEC, WEF Specialty

Conferences. We also engaged directly with technical and key decision makers in the wastewater industry. We targeted both state and national level utilities such as the Dallas Water Utility, the Washington DC Water and Sewerage Authority, and City of Houston. We also reached out consulting companies that worked in the wastewater arena. We also developed strong links with eBeam technology providers as well as with key individuals in state and federal agencies such as the US EPA, Department of Energy, Department of Defense, and Texas Water Development Board.

4. RESULTS

4.1. Efficacy of the technology to disinfect sewage sludges

Table 1 shows the D₁₀ values of the target organisms (specific pathogens and indicator organisms) when exposed to eBeam irradiation in sewage sludge samples obtained from aerobic and anaerobic digesters.

TABLE 1. MEAN D₁₀ VALUES OF DIFFERENT TARGET ORGANISMS IN AEROBICALLY AND ANAEROBICALLY DIGESTED SEWAGE SLUDGE SAMPLE UPON E-BEAM IRRADIATION

Target Organisms	Mean D ₁₀ value (kGy)	
	Aerobically digested	Anaerobically digested
Spiked <i>Salmonella</i> Typhimurium	0.28 ±0.01 ^A	0.23±0.01 ^B
Indigenous <i>Escherichia coli</i>	0.31±0.01 ^A	0.25±0.01 ^B
Indigenous Aerobic spores	3.75±0.24 ^A	4.04± 0.33 ^A
Indigenous Anaerobic spores	4.96±0.34 ^A	3.12±0.08 ^B
Spiked Somatic coliphage	4.02±0.38 ^{A1}	4.07±0.31 ^{A1}
Spiked Male specific coliphage	2.25±0.19 ^{A2}	2.45±0.16 ^{A2}
Spiked Poliovirus	<i>Not determined</i>	2.07±0.69
Spiked Rotavirus	<i>Not determined</i>	1.53±0.03

Means within the same row having similar letters are not significantly different ($p>0.05$). Means within the same column with similar numbers are not significantly different ($p>0.05$).

Both *E. coli* and *Salmonella* sp. were inactivated upon exposure to eBeam irradiation. When exposed to approximately 1.0 kGy, *E. coli* number decreased by about 3.2 log units in the aerobic sludge samples and by approximately 3.8 log units in the anaerobically digested sludge. Similarly, the *Salmonella* sp. counts were reduced by around 3.7 log units in the aerobic sludge samples and by 4.5 log units in the anaerobic sludge samples. *E. coli* and *S. Typhimurium* had a D₁₀ value of 0.31±0.01 and 0.28 ±0.01 kGy respectively in aerobically treated sludge. The D₁₀ values of *E. coli* and *S. Typhimurium* in anaerobically treated sludge samples 0.25±0.01 and 0.23±0.01 kGy respectively were statistically significantly different ($p= 0.007$ and 0.011 respectively) compared to the reduction observed in the aerobic sludge (Table 17.1). E-beam irradiation was able to inactivate both aerobic and anaerobic spores.

Compared to bacterial inactivation, higher e-beam dose was required for the inactivation of aerobic and anaerobic spore formers in both types of sludge matrices. In the aerobic sludge samples, the titres of the aerobic and anaerobic spores were reduced by approximately 1.6 and 1.2 log units respectively when exposed to approximately 6.0 kGy dose. In case of anaerobic sludge samples, the reduction was approximately 1.5 log units for both aerobic and anaerobic spore formers respectively. The aerobic and anaerobic spore forming bacteria showed D₁₀ values of 3.75±0.24 and 4.96±0.34 kGy in aerobically treated sludge matrix and in

anaerobically treated sludge the D₁₀ value was calculated to be 4.04±0.33 and 3.12±0.08 respectively. There was a significant difference in D₁₀ values of anaerobic spore formers between the two sludge matrices (p<0.001), However, no such difference was observed in case of aerobic spore formers (p=0.293).

Reductions of somatic and male-specific coliphages are shown in Table 1. These samples were also exposed to higher doses of e-beam irradiation as compared to the bacterial targets. In both aerobic and anaerobic sludge samples, male specific coliphage was observed to be more susceptible to inactivation by e-beam irradiation compared to that of somatic coliphages. Somatic coliphages were reduced by approximately 2.5 log units when exposed to ~10 kGy whereas male-specific coliphages were reduced by approximately 4 log units. As per these findings, estimated D₁₀ values of somatic coliphage in aerobically and anaerobically treated sludge samples were relatively high i.e., 4.02±0.38 kGy and 4.07±0.31 kGy, where as that of male specific coliphage were 2.25±0.19 and 2.45±0.16 kGy. There was no significant difference in the D₁₀ values of male-specific coliphages (p =0.4) in the two different types of sludges. The relatively lower D₁₀ values of male specific coliphage in sewage sludge indicate their overall higher susceptibility to e-beam irradiation compared to somatic coliphages. Table 2 shows the approximate log reduction that can be expected with sewage sludges are exposed to 10 kGy eBeam dose.

TABLE 2. APPROXIMATE (LOG₁₀) REDUCTION OF DIFFERENT TARGET ORGANISMS IN AEROBICALLY AND ANAEROBICALLY DIGESTED SEWAGE SLUDGE WHEN EXPOSED TO 10 KGY E-BEAM IRRADIATION

Target Organisms	Approximate log ₁₀ reduction at 10 kGy	
	Aerobically digested	Anaerobically digested
<i>Salmonella</i> Typhimurium	36	43
Indigenous <i>Escherichia coli</i>	32	40
Indigenous Aerobic spores	3	2
Indigenous Anaerobic spores	2	3
Somatic coliphage	2	2
Male specific coliphage	4	4
Poliovirus	nd	5
Rotavirus	nd	7

nd: not determined

4.2.Efficacy of the technology to disinfect wastewater effluent

Table 3 shows the D₁₀ values of the selected microbial pathogens and surrogate organisms when present in wastewater effluents.

TABLE 3. D10 VALUES OF SPECIFIC TARGET PATHOGENS WHEN EXPOSED TO EBEAM IRRADIATION IN TERTIARY TREATED WASTEWATER EFFLUENT

Target Organism	D ₁₀ value
<i>Salmonella</i> spp. cocktail	0.156 ± 0.03 ^A
<i>Shigella</i> spp. cocktail	0.097 ± 0.02 ^B
Aeromonas spp cocktail	0.066 ± 0.01 ^C
Hepatitis A virus	4.386 ± 0.34 ^D
Murine norovirus	3.769 ± 0.19 ^E
Rotavirus	1.449 ± 0.15 ^F
<i>Cryptosporidium parvum</i>	0.032 ± 0.002 ^G

Other than the enteric viruses, the protozoan pathogen and the bacterial pathogens were sensitive to eBeam irradiation. The enteric viruses had significantly higher D₁₀ values as compared to the bacterial and protozoan pathogens. Table 4 shows the theoretical reduction of pathogens that can be expected when tertiary treated wastewater is exposed to 3 different eBeam dose levels. The enteric viruses are significantly more resistant to eBeam irradiation doses as compared to the protozoan and bacterial pathogens.

TABLE 4. THEORETICAL REDUCTION OF TARGET MICROBIAL PATHOGENS WHEN EXPOSED TO VARYING EBEAM IRRADIATION DOSES.

Target Organism	Log10 reduction when exposed to varying eBeam doses		
	1 kGy	5 kGy	10 kGy
	5.92	29.62	59.25
	10.02	50.10	100.20
	15.09	75.45	150.92
	0.23	1.14	2.28
	0.27	1.33	2.65
	0.69	3.45	6.90
	30.96	154.80	309.60

The results suggest that choosing the eBeam dose for water reuse applications have to be done with careful consideration to the target log₁₀ reduction of the enteric viruses. Given that viruses are significantly more resistant than bacterial or protozoan pathogens, setting the eBeam dose based on viruses, would achieve the needed safety margins for bacterial and protozoan inactivations.

4.3. Economic analysis of eBeam technology for the wastewater industry

Table 5 provides an overview of the dry tons per year throughput for the 10 MGD, 50 MGD and 90 MGD scenarios. This is assumed based a 4% solids content in the sludge stream.

TABLE 5: SLUDGE THROUGHPUT ESTIMATES (DRY KG/SEC) AS A FUNCTION OF PLAN THROUGHPUT (MGD)

Gallons/day	Gallons/min	Solids (%)	Dry lbs/sec	Dry kg/sec	Dry tons/year
	6944	4%	0.48	5.43	7610
	34722	4%	2.41	27.15	38051
	62500	4%	4.34	48.87	68492

In e-beam processing, the relationship between dose, power and mass throughput of a product through the e-beam system is given by the relationship

$$\frac{\text{Average beam power (kW)}}{\text{minimum required dose}} \times \text{throughput efficiency (\%)} = \text{Mass (kg/sec) processed} \quad (1)$$

The throughput efficiency is based on a number of engineering issues such as the conveyor system efficiency, possible over scanning of the beam, etc. Some equipment manufacturers claim a beam efficiency between 70% and 90%. We used a hypothetical efficiency of 80%. Assuming a target dose of 10 kGy, Table 6 provides the eBeam power requirements for treating throughput estimates as mentioned from Table 5.

TABLE 6. EBEAM POWER REQUIREMENTS FOR TREATING VARYING SLUDGE THROUGHPUTS

Gallons/day	Target sludge throughput (kg/sec)	eBeam dose (kGy)	eBeam power requirements (kW)
	5.43	10	68
	27.15	10	339
	48.87	10	611

From Table 6 it is evident that the minimum power requirement is a 70kW accelerator for the smallest sized facility and up to 611 kW for the largest sized community under evaluation. It quickly becomes evident that the technology for handling the required sewage sludge throughput does not exist. The need to deliver high (~10 kGy) doses for sewage sludges brings up additional technical challenges in terms of which technology to choose (Dynamitron vs linacs vs Rhodotrons).

Based on input from eBeam system manufacturers and installers, the capital costs for installing one 100 kW linear accelerator was estimated to total around \$ 3.3 million [6]. These costs include costs associated with shielding, biosolids material handling system, design and engineering costs, etc. To calculate the operating costs, the amortization costs (8% interest over 15 year's life span), labour and maintenance costs were included. Table 7 provides an estimate for the processing costs (\$ per dry ton) of sludge to achieve Class A biosolids in the different treatment plants of varying throughputs. To estimate these figures, a three-step calculation was employed. The first step determined the cost per day of the initial capital investment. To accomplish this task, it was necessary to establish an average plant lifespan. We used a formula to establish the annual amortization payment (AAP). The AAP assumed a 15 year plant life span and an interest rate of 8%. To calculate this value, the capital cost was multiplied by the conversion factor of 0.117, yielding the AAP. Using the AAP, the capital cost per dry ton (Capital cost/dry ton) was calculated. Since dry ton values are reported as dry tons per day (dtpd), it was necessary to divide the AAP by 365 days.

$$\text{Capital}\$/\text{dt} = (\text{AAP}/365 \text{ days/year})/\text{dtpd} \quad (2)$$

Plant lifespan was not necessary in O&M calculation as O&M costs are recorded on a per year basis. Therefore the O&M\$/year was divided by 365 days/year to arrive at O&M\$/day. The O&M\$/dtpd calculation followed the same formula as what was used for capital cost estimations.

$$\text{O\&M}\$/\text{day} = \text{O\&M} (\$/\text{year}) / 365 (\text{days}/\text{year}) \quad (3)$$

$$\text{O\&M}\$/\text{dt} = \text{O\&M} (\$/\text{day}) / \text{dtpd} \quad (4)$$

The values for Capital\$/dt and O&M\$/dt were added together to arrive at the Total\$/dt (Table 4). From Table 4 it is evident that the cost of eBeam treatment per dry ton decreases significantly as the throughput volume increases. The cost of treating sludge from a 10 MGD plant is approximately \$300 while it costs only \$72, which is almost 24% less. Thus it is evident how this technology becomes financially very attractive to mid to large scale wastewater treatment plants. Choosing a process upgrade at a cost that is significantly lesser than what US cities currently pay for land application or land disposal is a key driver in decision-making. Today, cities have to spend somewhere between \$150/dt and \$250/dt for land application [7].

TABLE 7. EBEAM PROCESSING COSTS FOR BIOSOLIDS OF VARYING TREATMENT PLANT THROUGHPUTS

System	Capacity	Dry Tons/day	Capital Costs	Annual Amortization	Annual O&M	Total \$/dt
eBeam	10 MGD /100kW	7dtpd	\$3 323 350	\$388 832	\$366 168	\$ 311
eBeam	50 MGD /100kW	35dtpd	\$3 323 350	\$388 832	\$366 168	\$ 62
eBeam	50 MGD /400kW	35dtpd	\$7 635 053	\$893 301	\$581 753	\$ 143
eBeam	100 MGD /400kW	70dtpd	\$7 635 053	\$893 301	\$581 753	\$ 72

4.4.Engage the wastewater industry stakeholders to promote the technology

We spent considerable effort as outreach and education activities targeting the wastewater industry stakeholders. Early on in the project, we chose a Houston based company as our commercial partner. This company met several criteria including that it was a relatively small, privately owned progressive wastewater company with a track record of having successfully installed automated wastewater screening equipment in plants around the world. The company had won many accolades including one of the “Fastest growing businesses in Houston” among others. The company had offices in the US, Canada, Middle East and India and thus had a large overview of what was required in different parts of the world. The company signed an options agreement with the university agreeing to commercialize the technology within a 2-year time frame and with set milestones. However, due to strategic reasons the company did not move forward to with adopting eBeam technology as one of its core technologies.

We also spent effort in reaching out to the wastewater utilities in Houston and Dallas. The engagement with the City of Dallas has progressed beyond performing irradiation trials for their particular samples; there are strategies to fund specific R&D projects as well as explore possible opportunities to build a pilot scale facility currently under review. Our efforts at working with federal and state agencies have also borne fruit. The Department of Energy Office of Physics’ Accelerators for America program organized a workshop in summer 2015 to review the technical and regulatory bottlenecks that are preventing rapid commercialization

of this technology. The author was directly involved in this workshops' planning, serving as a task leader for one of the thematic areas as well as preparing the final report. The DOE's activities have resulted in a multi-million dollar research and development program targeting the development of 1MW or higher linear accelerators.

5. SUMMARY

The research has shown that eBeam technology is capable of inactivating a variety of microbial pathogens in sewage sludges and wastewater effluent. The dose per the US EPA biosolid-related regulations will be more than capable of achieving significant reductions of microbial pathogens. The economic analysis of eBeam treatment of sewage sludge suggests that the costs for treating sewage sludges decreases as the throughput volumes increase with costs ranging between \$311/dry ton for a 50 MGD (million gallons/day) treatment plant and \$ 72 for a 100 MGD facility. However, the analysis also pointed out that the current technology is currently limited for at least the US wastewater industry. No commercially available accelerators that are in the 1MW class or higher power exist anywhere in the world. This project clearly identified that 1MW or higher accelerators are needed for this technology to be of real value to the wastewater industry. The outreach and education activities targeting the wastewater industry stakeholders were successful. The metrics of success is based on the interest shown by the wastewater utilities as well as the initiation of a grant-funding program by the DOE to support the design and construction of 1 MW or higher accelerators. This is no different from other eBeam processing scenarios where the treatment costs should decrease with increasing product throughput. Economic analysis of such types needs to be continually refined to obtain the best cost estimates for this technology.

ACKNOWLEDGEMENT

The authors thank the International Atomic Energy Agency, Texas AgriLife Research H8708 and USDA NIFA their support. We also thank the various individuals from the eBeam industry who were willing to provide much needed clarity on costs, etc. Data presented in Tables 1 & 2 are with permission from ref [1].

REFERENCES

- [1] PRAVEEN, C., P.R. JESUDHASAN, R. REIMERS AND S.D. PILLAI., Electron beam inactivation of selected microbial pathogens and indicator organisms in aerobically and anaerobically digested sewage sludge. *Bioresources Technology* (2013) **144**: 652–657
- [2] REIMERS, R.S., Y.XU, J.A. OLESZKIEWICZ, S.D. PILLAI, K. B.FITZMORRIS-BRISOLARA., AND G.SEIDL., Future directions of biosolids management in the second decade of the 21st century: a review. IWA Conference on Holistic Sludge Management, Stockholm, Sweden (2012)
- [3] USEPA, 40 CFR Parts 257, 405, and 503 (FRO-4203-3): Standards for Use and Disposal of Sewage, Final Rule. Fed Register, **58**, **9248**. US Government Printing Office, Washington, DC (1993).
- [4] WANG, J. and WANG, J., Application of radiation technology to sewage sludge processing: a review, *Journal of Hazardous Materials*. Volume 143. 2007. p. 2-7.
- [5] MILLER, R.B., *Electronic irradiation of foods: an introduction to the technology*. (2005) Springer
- [6] SANDBERG, M.A, REIMERS, R.S., AND PILLAI, S.D., Economic Assessment of the Competitive Application for E-beam Process in the Treatment of Waste Residuals, A Paradigm International, Inc. report to HeadworksBIO, Inc. Houston, Texas (2013).

- [7] FITZMORRIS-BRISOLARA, K.B., REIMERS, R.S., SMITH, J.E., RUBIN, A.R., PARRY, D.L., DONOVAN, J.F., FASCHON, A., WANSTROM, C. AND ZAPPI, P.” Management Protocols for Development of Value-Added Products, “WEF Residuals and Biosolids Specialty Conference, Milwaukee, Wisconsin. 2016

ACRONYMS AND ABBREVIATIONS

2-Cl-Ph	chlorophenol
AOPs	advanced oxidation process
AAm/NVP	acrylamide /2-vinylpyrrolidone
AOX	adsorbable organic halides
ARPs	advanced reduction processes
ASP	activated sludge process
BOD	biochemical oxygen demand
BPA	bisphenol A
BP3	benzophenone-3
BP4	benzophenone-4
BBP	Butyl benzyl phthalate
CBZ	carbamazepine
CBT	closed bottle tests
CHBA	3-chloro-4-hydroxybenzoic acid
COD	chemical oxygen demand
CRP	coordinated research project
CS	control system
DNA	deoxyribonucleic acid
DBP	di-n-butyl phthalate
DCF	diclofenac
DCM	dichloromethane
DCHP	dicyclohexyl phthalate
DDTs	dichlorodiphenyltrichloroethanes
DEHP	Di (2-ethylhexyl) phthalate
DEP	Diethyl phthalate
DES	diethylstilbestrol

DHP	Di-hexyl phthalate)
DMEM	Dulbecco's Modified Eagle's Medium
DO	dissolved oxygen
DPP	Di-n-pentyl phthalate
DprP	Di-propyl phthalate
DPPH	2,2-diphenyl-1-picrylhydrazyl
EB (eBeam)	electron beam
ECd	electron capture detection
EDTA	ethylenediaminetetraacetic acid
EDCs	endocrine disrupting chemicals
EOC	organic emerging contaminants
ESI	electrospray ionization
FH	fluoxetine hydrochloride
FNT	fenitrothion
FRAP	Ferric reducing power assay
GC-MS	gas chromatography–mass spectrometry
HED	high energy dynode
HCB	hexachlorobenzene
HPLC	high-performance liquid chromatography
HRT	hydraulic retention time
HMOR	hydrophobic high-silica mordenite-type zeolite
IC	inorganic carbon
keV	kilo electron volt
LC-MS/MS	Liquid chromatography triple quadropole
LMC	lincomycin
MeV	mega electron volt
MEB	mobile electron beam

MF	microfiltration
MGD	million gallons/day
MMA	methyl methacrylate
MLVSS	mix liquor volatile suspended solid
MO	methyl orange
MRM	multiple reaction monitoring
MS	mass spectrometry
MS/MS	triple quadrupole tandem mass spectrometer
MSIP	Ministry of Science, ICT and Future Planning
NAF	naphthalene
NaA	zeolites A-type
NaX	zeolites X-type
NaMOR	zeolites mordenite-type
NET	new environmental technology
NF	nanofiltration
NRF	National Research Foundation
NVP/NA	N-vinylpyrrolidone-acrylonitrile
OFX	ofloxacin
O&M	operation&maintenance
PAHs	polycyclic aromatic hydrocarbons
PCB	polychloro byphenils
PPCPs	pharmaceutical and personal care products
PPRIs	photochemically produced reactive intermediates
PVA/AA	polyvinyl alcohol/acrylic acid
PANI- TiO ₂	polyaniline–TiO ₂ nanocomposites
PFOA	perfluorooctanoic acid
POPs	persistent organic pollutants

PTFE	polytetrafluoroethylene
RAS	return activated sludge
Rt	retention time
RO	reverse osmosis
SAW	spot area weight
SD	standard deviation
SIM	single ion monitoring
SMT	sulfamethazine
SMX	sulfamethoxazole
SPE	solid phase extraction
SSL	split splitless
TC	total carbon
TCEP	Tris (2-chloroethyl) phosphate
TCN	tetracycline
ThOD	theoretical oxygen demand
TIC	total ion chromatogram
TLC	thin layer chromatography
TN	total nitrogen
TOC	total organic carbon
TRX	triton X-100
TSA	Tryptone Soya Agar
TSB	Tryptone Soya Broth
TU	toxic unit
WEF	Water Environment Federation
WWTPs	wastewater treatment plants
UASB	using radiation and anaerobic treatment
UFLC	ultra-fast liquid chromatographic

UF

ultrafiltration

UV

ultraviolet

Takacs, E. MTA Energiatudományi Kutatóközpont
Hungarian Academy of Sciences
Centre for Energy Research
29-33, Konkoly-Thege Miklos street
1121 BUDAPEST
HUNGARY

Virgolici, M. IRASM
"Horia Hulubei" National Institute of Physics and Nuclear Engineering (IFIN-HH)
30 Reactorului Str.
RO-077125, MAGURELE, ILFOV
ROMANIA

Wang, J. Tsinghua University, Institute of Nuclear and New Energy Technology (INET)
Energy Science Bldg., BEIJING 100084
CHINA

Zanelli, A. Institute ISOF-CNR
Via P. Gobetti 101
40129 BOLOGNA
ITALY

Zimek, Z. Department of Radiation Chemistry and Technology
Institute of Nuclear Chemistry and Technology
ul. Dorodna 16, 03-195 WARSAW,
POLAND

RESEARCH COORDINATION MEETINGS

7–11 May 2011
Vienna, Austria

29 October–2 November 2012
Jeongeup, Republic of Korea

18–23 May 2014
Budapest, Hungary

15–19 November 2015
Beijing, China



IAEA

International Atomic Energy Agency

No. 25

ORDERING LOCALLY

In the following countries, IAEA priced publications may be purchased from the sources listed below or from major local booksellers.

Orders for unpriced publications should be made directly to the IAEA. The contact details are given at the end of this list.

CANADA

Renouf Publishing Co. Ltd

22-1010 Polytek Street, Ottawa, ON K1J 9J1, CANADA

Telephone: +1 613 745 2665 • Fax: +1 643 745 7660

Email: order@renoufbooks.com • Web site: www.renoufbooks.com

Bernan / Rowman & Littlefield

15200 NBN Way, Blue Ridge Summit, PA 17214, USA

Tel: +1 800 462 6420 • Fax: +1 800 338 4550

Email: orders@rowman.com Web site: www.rowman.com/bernan

CZECH REPUBLIC

Suweco CZ, s.r.o.

Sestupná 153/11, 162 00 Prague 6, CZECH REPUBLIC

Telephone: +420 242 459 205 • Fax: +420 284 821 646

Email: nakup@suweco.cz • Web site: www.suweco.cz

FRANCE

Form-Edit

5 rue Janssen, PO Box 25, 75921 Paris CEDEX, FRANCE

Telephone: +33 1 42 01 49 49 • Fax: +33 1 42 01 90 90

Email: formedit@formedit.fr • Web site: www.form-edit.com

GERMANY

Goethe Buchhandlung Teubig GmbH

Schweitzer Fachinformationen

Willstätterstrasse 15, 40549 Düsseldorf, GERMANY

Telephone: +49 (0) 211 49 874 015 • Fax: +49 (0) 211 49 874 28

Email: kundenbetreuung.goethe@schweitzer-online.de • Web site: www.goethebuch.de

INDIA

Allied Publishers

1st Floor, Dubash House, 15, J.N. Heredi Marg, Ballard Estate, Mumbai 400001, INDIA

Telephone: +91 22 4212 6930/31/69 • Fax: +91 22 2261 7928

Email: alliedpl@vsnl.com • Web site: www.alliedpublishers.com

Bookwell

3/79 Nirankari, Delhi 110009, INDIA

Telephone: +91 11 2760 1283/4536

Email: bkwell@nde.vsnl.net.in • Web site: www.bookwellindia.com

ITALY

Libreria Scientifica "AEIOU"

Via Vincenzo Maria Coronelli 6, 20146 Milan, ITALY
Telephone: +39 02 48 95 45 52 • Fax: +39 02 48 95 45 48
Email: info@libreriaaeiou.eu • Web site: www.libreriaaeiou.eu

JAPAN

Maruzen-Yushodo Co., Ltd

10-10 Yotsuyasakamachi, Shinjuku-ku, Tokyo 160-0002, JAPAN
Telephone: +81 3 4335 9312 • Fax: +81 3 4335 9364
Email: bookimport@maruzen.co.jp • Web site: www.maruzen.co.jp

RUSSIAN FEDERATION

Scientific and Engineering Centre for Nuclear and Radiation Safety

107140, Moscow, Malaya Krasnoselskaya st. 2/8, bld. 5, RUSSIAN FEDERATION
Telephone: +7 499 264 00 03 • Fax: +7 499 264 28 59
Email: secnrs@secnrs.ru • Web site: www.secnrs.ru

UNITED STATES OF AMERICA

Bernan / Rowman & Littlefield

15200 NBN Way, Blue Ridge Summit, PA 17214, USA
Tel: +1 800 462 6420 • Fax: +1 800 338 4550
Email: orders@rowman.com • Web site: www.rowman.com/bernan

Renouf Publishing Co. Ltd

812 Proctor Avenue, Ogdensburg, NY 13669-2205, USA
Telephone: +1 888 551 7470 • Fax: +1 888 551 7471
Email: orders@renoufbooks.com • Web site: www.renoufbooks.com

Orders for both priced and unpriced publications may be addressed directly to:

Marketing and Sales Unit
International Atomic Energy Agency
Vienna International Centre, PO Box 100, 1400 Vienna, Austria
Telephone: +43 1 2600 22529 or 22530 • Fax: +43 1 2600 29302 or +43 1 26007 22529
Email: sales.publications@iaea.org • Web site: www.iaea.org/books

International Atomic Energy Agency
Vienna
ISBN 978-92-0-107818-6
ISSN 1011-4289